

C 2030 duo plus
Art. 1874

-
- D Betriebsanleitung**
Bewässerungscomputer
-
- GB Operating Instructions**
Water Computer
-
- F Mode d'emploi**
Programmateur d'arrosage
-
- NL Instructies voor gebruik**
Besproeiingscomputer
-
- I Istruzioni per l'uso**
Computer per irrigazione
-
- E Manual de instrucciones**
Programador de riego
-
- P Instruções de manejo**
Computador de rega

GARDENA Water Computer C 2030 duo plus



Translation of the original instructions from German.

Please read these operating instructions carefully and observe the information they contain. Use these operating instructions to familiarise yourself with the product, the proper use and the safety instructions.



For safety reasons, children and young people under the age of 16, as well as people not familiar with these operating instructions, should not use this product. Persons with reduced physical or mental abilities may use the product only if they are supervised or instructed by a responsible person.

→ Please keep these operating instructions in a safe place.

Contents

1. Where to Use Your GARDENA Water Computer	16
2. Safety Instructions	16
3. Function	17
4. Initial Operation	19
5. Programming	21
6. Storage	25
7. Maintenance	26
8. Troubleshooting	26
9. Available Accessories	27
10. Technical Data	27
11. Service / Warranty	28

1. Where to Use Your GARDENA Water Computer

Intended use:

The GARDENA Water Computer is intended for private use in domestic and hobby gardens, exclusively for outdoor use, to control sprinklers and watering systems. The Water Computer has two separate outlets and can be used e.g. for automatic irrigation during your holiday.

Please note:



The GARDENA Water Computer must not be used for industrial purposes or in conjunction with chemicals, foodstuffs, easily flammable and explosive materials.

2. Safety Instructions

Battery:

To ensure the Water Computer runs safely, only a 9V alkaline manganese battery (alkaline) type IEC 6LR61 must be used.

In order to stop the Water Computer from failing because of a weak battery if you are away for a long time, the battery must be replaced when the battery display still shows only 1 bar.

Setting up

Warning!

The Water Computer must not be used indoors.

→ Only use the Water Computer outdoors.

The Water Computer may only be set up vertically with the sleeve nut to the top to prevent water penetrating into the battery compartment.

The minimum water output to ensure correct functioning of the Water Computer is 20 - 30 l/h per outlet. E.g. for controlling the Micro-Drip System, at least 10 pieces 2-litre Drip Heads are required.

At high temperatures (over 60 °C at the display) the LCD display may extinguish. This does not affect the program in any way. When the computer cools down the LCD display illuminates again.

The max. temperature for the water flow is 40 °C.

→ Only use clear fresh water.

The minimum operating pressure is 0.5 bar, the maximum operating pressure is 12 bar.

Avoid tensile strain.

→ Do not pull the hose connected to the Water Computer.

Programming

→ Program the Water Computer with the tap turned off.

In this way, you can prevent unintentional water penetration.

You can remove the control unit from the housing to program the Water Computer.

If the controller is removed when the valve is open, the valve remains open until the controller is fitted again.

3. Function

With the Water Computer, the garden can be watered fully automatically up to 3 times a day (every 8 hours) via both outlets. Sprinklers, a sprinkler system or a drip head watering system can be used for watering.

The Water Computer carries out watering fully automatically according to the set program and can therefore also be used during holidays. Early in the morning or late in the evening, evaporation and therefore water consumption is lowest.

Controls:

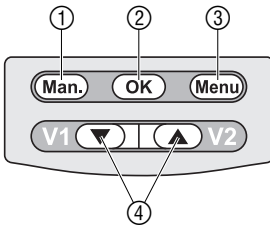

The watering programme is easily entered using the controls.

Control

- ① **Man. button**
- ② **OK-Taste**
- ③ **Menu button**
- ④ **▼-▲ buttons (V1/V2)**

Function

- For switching the water throughput on or off manually.
- Applies the values set with the ▼-▲ buttons.
- Changes to the next programme level.
- Change the adjustable values in each level/selection of outlet (V1/V2) in Level 1.

Display levels:

The 6 display levels can be selected one after the other by pressing the **Menu** key.

- Level 1: **Normal display**
- Level 2: **Current time and day of the week**
- Level 3: **Watering start time**
- Level 4: **Watering duration**
- Level 5: **Watering frequency**
- Level 6: **Switch programme on or off / Deactivate sensor**

Display messages:

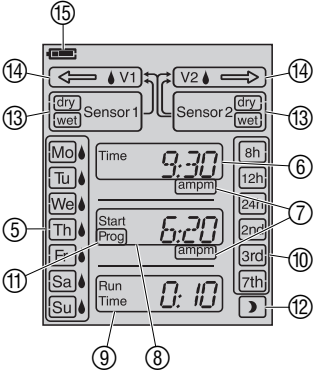

The display level can be changed at any time by pressing the **Menu** button. All programme data changed up to this time and confirmed with the **OK** button is saved. If data is changed during programmed irrigation and confirmed with the **OK** button then the valve is closed.

Display	Description
⑤ Weekdays Mo, Tu, ...	Current weekday <input type="checkbox"/> or programmed watering days ☼.
⑥ Time	Current time of day (flashes when in input mode).
⑦ am / pm	Display for 12-hour clock (e.g. in USA, Canada).
⑧ Start	Watering start time (flashes when in input mode).
⑨ Run Time	Watering duration (flashes when in input mode).
⑩ 8h, 12h, 24h, 2nd, 3rd, 7th	Watering cycle (with <input type="checkbox"/> activated). Every 8 / 12 / 24 hours; every 2nd / 3rd / 7th day.
⑪ Prog ON / OFF	Watering programme on (ON) / off (OFF).
⑫ Direct sensor control	Watering is automatically controlled between 20:00 and 06:00 via the Soil Moisture Sensor.
⑬ Sensor 1 / 2 dry / wet	Dry sensor dry : watering is carried out. Wet sensor wet : watering is not carried out.
⑭ Valve ← V1 / Valve V2 →	The arrow indicates the selected valve: - displayed ☼: the valve is connected - flashing ☼: the valve is open
⑮ Battery	Indicates 5 battery levels: 3 bars: Battery fully charged 2 bars: Battery half full 1 bar: Battery low 0 bar: Battery almost flat Frame is flashing: Battery flat

If the battery frame is flashing, the valve is no longer opened. **A valve opened by the programme will also close again if the battery is flat.** The battery display is reset when the battery is changed.

2 Bars	1 Bar	0 Bar	Frame is flashing
Battery half full	Battery low	Battery almost flat	Battery flat
Valve opens.	Valve opens.	Valve still opens.	Valve does not open.
The Water Computer is guaranteed to work for a minimum of 4 more weeks.	The Water Computer will continue to work for no more than 4 weeks.	The Water Computer stops working soon.	The Water Computer stops working.
	It is advisable to change the battery.	The battery must be changed soon.	The battery must be changed.
	→ Replace battery (see 4. Initial Operation "Inserting battery").		

4. Initial Operation

Insert battery:

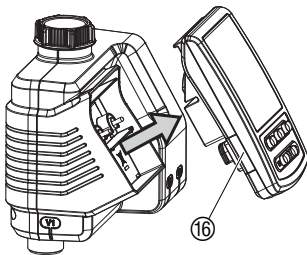

The Water Computer must only be operated with a 9 V alkali-manganese (alkaline) battery type IEC 6LR61.

1. Remove controller ⑯ from the housing of the Water Computer.
2. Insert battery in the battery compartment ⑰. **Observe correct polarity P.** *The display shows all the LCD-symbols for 2 seconds and then moves to the time/day of week level.*
3. Install controller ⑯ on the housing again.

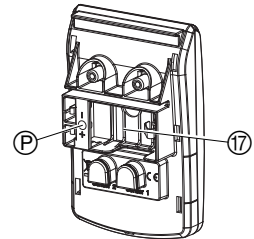

Set display to 24-hours or 12-hours (am/pm):

The factory setting is the 24-hour display.

→ Press the **Man.** button continuously while inserting the battery.

Connect soil moisture or rain sensor (optional):

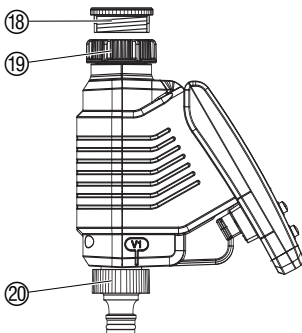

The Water Computer is fitted with a sleeve nut ⑱ for taps with (G 1") (33.3 mm) thread. The adaptor supplied ⑱ allows the Water Computer to be connected to taps with a (G 3/4") thread (26.5 mm).

1. **For tap with a G 3/4" (26.5 mm) thread:**
Screw adaptor ⑱ on to the tap manually (do not use pliers).
2. Screw sleeve nut ⑱ of the Water Computer on to the adaptor thread by hand (do not use pliers).
3. Screw Tap Connectors ⑳ onto the two Water Computer outlets.

Connect Soil Moisture Sensor or Rain Sensor (optional):

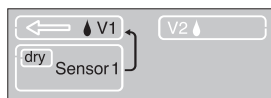
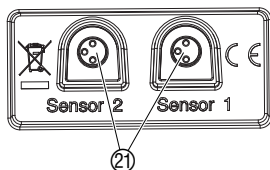
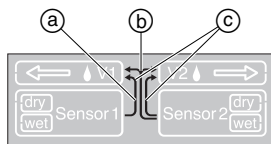

2.

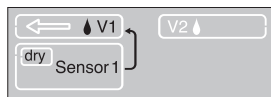

3.



Fit anti-theft device (optional):

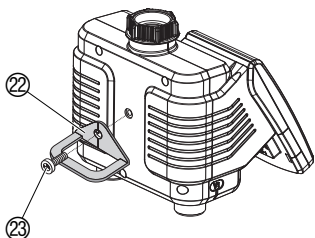

In the case of rain, or when the soil is sufficiently moist, a programmed, automatic watering programme will be stopped or prevented from starting. Manual operation is possible at all times.

Sensor assignment:

- a) A sensor in Connector 1 : Sensor only applies to Valve 1
- b) A sensor in Connector 2 : Sensor applies to both valves
- c) Sensor in Connectors 1 and 2 : Sensor 1 applies to Valve 1, Sensor 2 applies to Valve 2

1. Place Soil Moisture Sensor in watered area
– or –
place Rain Sensor **outside** of the watered area.
2. Remove controller (16) from the housing of the Water Computer.
3. If necessary, connect sensor to Extension Cable or Adaptor at the sensor connection (21) of the Water Computer.

Activate sensor:

A sensor will be automatically activated after 60 sec. The sensor assignment (a), (b) or (c) (arrow) and the current sensor status **dry / wet** will be displayed.

E.g. Sensor 1 **dry** (dry) Valve 1 (a) only.

Deactivate sensor [Level 6]:

If watering is to be without a sensor, although a sensor was previously activated, then this sensor must be deactivated.

1. Remove sensor from Water Computer.
2. Press **Menu** button 5 times [Level 6].
*The sensor assignment (a), (b) or (c) (arrow) and the current sensor status **dry / wet** will be displayed.*
3. Press **OK** button.
The sensor has been deactivated.

To connect older sensors (with 2-pin connector), the **GARDENA Adapter Cable 1189-00.600.45** is required, which can be procured from GARDENA Service.

To secure your Water Computer against theft, you can obtain the **GARDENA Anti-theft device Art. No. 1815-00.791.00** from GARDENA Service.

1. Screw clamp (22) with screw (23) firmly to the back of the Water Computer.
2. Use clamp (22) e.g. for fixing a chain.

It is no longer possible to remove the screw after it has been screwed in.

5. Programming

Set current time and day of week:

[Level 2]

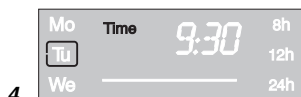
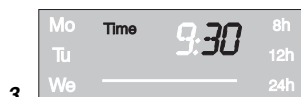

To set the programme, the controller can be removed and mobile programming can be carried out (see 4. Initial Operation “Inserting battery”).

Programming can be discontinued at any time by pressing the **Man.** button. All programme data changed up to this time and confirmed with the **OK** button is saved.

1. Press **Menu-key [Level 2]** (not necessary if the battery has just been inserted).
The hours display and Time flash.
2. Set the time in hours with the **▼-▲** button (example: **9** hours) and confirm with the **OK**-key.
Time and the minutes display flash.
3. Set the time in minutes with the **▼-▲** button (example: **30** minutes) and confirm with the **OK**-key.
Time and the day of the week display flash.
4. Set day of week with the **▼-▲** buttons (e.g. **(Tu)**) and confirm with the **OK** button.
The display moves to the message “Entering watering programme” of the watering mode “Scheduled watering” [Level 3].
Start Prog and the hours will flash on the display.

Watering modes:

The Water Computer has 3 watering modes:

A) Scheduled watering:

With the “scheduled watering”, watering begins as per the set programme. There is the additional option to consider soil moisture or rain in the watering programme. In the case of rain or sufficiently moist soil, the programme’s stop is activated or activation of the programme is prevented. Manual watering **Man. + OK** is still possible.

B) Direct sensor control):

With “direct sensor control”, watering is exclusively controlled in dependency on soil moisture between 20:00 and 06:00, if the sensor has indicated **dry**. 1 or 2 Soil Moisture Sensors can be connected.

C) Manual watering:

With “Manual watering”, watering begins immediately after **Man. + OK** has been pressed and can be operated independently of the sensor status.

Entering watering programme:

[Level 3]



[Level 4]

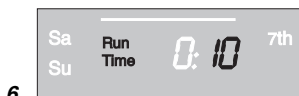
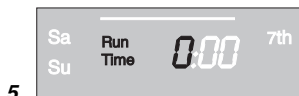

[Level 5]



A) Scheduled watering:

- Select programme for Valve 1 (↔ V1) or Valve 2 (V2 ↔) with the ▼-▲ buttons (V1/V2), (not possible if the current time of day and weekday have been previously entered).
- Press **Menu**-key twice [Level 3] (not necessary if the current time and day of the week has been entered).
Start Prog and the hours section flash on the display.
- Set the watering start time hours with the ▼-▲ button (E.g. 6) and confirm with the **OK**-key.
Start Prog and the minute display flashes on the screen.
- Set the minutes for starting the watering time with the ▼-▲ button (example: 20 minutes) and confirm with the **OK**-key.
Run Time and the hours for the watering time flash on the display.
- Set the hours for the watering time with the ▼-▲ button (example: 0 hours) and confirm with the **OK**-key.
Run Time and minutes for the watering time flash on the display.
- Set watering time minutes with the ▼-▲ button (example: 10 minutes) and confirm with the **OK**-key.
Watering cycle flashes on the display.

The watering frequency can be selected by:

- the (7.) watering cycle (right hand column of the display) – or –
- the (8.) watering days (left hand column of the display).

- Select **watering cycle** with the ▼-▲ button (E.g. 2nd) and confirm by pressing **OK**.

8h / 12h / 24h: Watering every 8 / 12 / 24 hours
2nd / 3rd / 7th: Watering every 2nd / 3rd / 7th day

The display jumps to the watering programme on the screen.

– or –

- Select each watering day with the ▼-▲ button (E.g. ☹ Mo, ☹ Fr Monday and Friday) and confirm by pressing **OK**. Press the **Menu** button.

Display moves to the message “Activate /deactivate watering programme” [Level 6].

If the following day is not a watering day, then watering only takes place until 0:00.

(Ex. watering days = Monday, Tuesday, Friday; Start time = 23:00; Water duration = 2h.
On Monday, watering takes place from 23:00 until Tuesday 01:00.
On Tuesday and Friday, watering takes place from 23:00 until 0:00.)

Activate /deactivate watering programme:

[Level 6]



The **Prog ON** must be selected so that the watering programme can start. With **Prog OFF** automatic watering is deactivated. **Prog ON / OFF** can be independently selected for each valve. Also with **Prog OFF** manual watering is possible.

1. Select Valve 1 (↔ **V1**) or Valve 2 (**V2** ↔) with the ▼-▲ button (**V1/V2**) (if a programme was previously created then the valve cannot be selected, the corresponding valve is automatically selected).
2. Press **Menu** button 5 times [Level 6] (not necessary if a programme was previously created).
3. Select **Prog ON** or **Prog OFF** with the ▼-▲ buttons and confirm with the **OK** button.

*For 2 sec. **Prog OK** is shown and then the display moves to the **Normal Display** [Level 1].*

Prog ON: The water computer has now been programmed, i.e. the inbuilt valve opens and closes completely automatically and thus waters at the programmed time.

B) Direct sensor control ☾ :

Prerequisite : at least one GARDENA Soil Moisture Sensor is connected (see 4. Initial Operation). Watering nights (20:00 – 06:00), if the sensor registers dry.

A previously set scheduled watering programme is stored but not carried out.

1. Select programme for Valve 1 (↔ **V1**) or Valve 2 (**V2** ↔) with the ▼-▲ buttons (**V1/V2**).

2. Press **Menu** button 3 times.

Run Time and the watering duration flash on the display.

3. Set watering duration hours with the ▼-▲ buttons (e.g. **0** hours) and confirm with the **OK** button.

Run Time and the watering duration minutes flash on the display.

4. Set watering duration minutes with the ▼-▲ buttons (e.g. **10** minutes) and confirm with the **OK** button.

Watering cycle flashes on the display.

5. Select direct sensor control ☾ with the ▼-▲ buttons and confirm with the **OK** button.

After each watering, a 2-hour watering pause is triggered in order for the Soil Moisture Sensor to record the soil moisture.

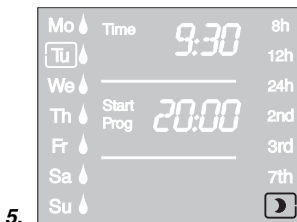
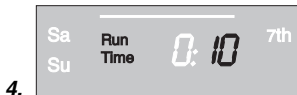

Example:
 Watering duration = 10 minutes
 Watering begins when the sensor registers dry (Sensor **dry**) between 20:00 and 06:00, and ends when the sensor registers wet (Sensor **wet**) or after 10 minutes at the latest.
 2 hours after the end of watering, if dry is registered (Sensor **dry**), watering is again initiated and with wet (Sensor **wet**) there is no further watering etc. for 2 hours up to max. 06:00. There is no watering between 06:00 and 20:00.

The watering duration is preset at the factory to 30 minutes.

Emergency programme (the moon ☾ flashes): If no sensor is inserted in the direct sensor control, or the connection cable is faulty, watering will take place every 24 hours. The watering duration depends on the set run time but is limited to a maximum of 30 minutes.

Exit direct sensor control [Level 5]:

1. Press **Menu** button 4 times.
The moon ☾ flashes on the display.
2. Select a different **watering cycle** with the **▼-▲** buttons and confirm with the **OK** button.

Read / modify watering programmes:

If a value in a programme is to be changed, this can be done without changing the other values in the programme.

1. Press the **Menu** key twice.
Start and the hours flash on the display.
2. Press the **Menu** button to jump to the next programme level
 – or –
 Change programme data with the **▼-▲** buttons and confirm with the **OK** button.

When the watering duration is changed while a program is running, the current watering cycle is ended.

C) Manual watering:

Each valve can be **opened or closed manually at any time**. A program-controlled open valve can also be closed early without changing the program data (watering start time, watering duration and watering frequency). The controller must be fitted.

1. Select Valve 1 (↔ **V1**) or Valve 2 (**V2** ↔) with the **▼-▲** buttons.
2. Press **Man.**-key to open the valve manually (or to close an open valve).

Run Time and the watering time in minutes (set to **30** minutes in the works) flash for 10 seconds on the display.



3.



3. Whilst the watering time in minutes is flashing, the watering duration can be modified with the ▼-▲ button (between **0:00** and **0:59**) (example: **10** minutes) and confirm with the **OK**-key.
4. Press **Man.**-key to close the valve early.
The valve is closed.

The amended manual opening period is stored, i.e. each time the valve is opened manually in future the modified opening period is preset. If the manual opening period is amended to **0:00**, the valve is closed and also remains closed after the **Man.**-key is pressed (child lock).

If the valve has been manually opened and a programmed start of watering overlaps with the manual opening duration then the watering programme will not be carried out.

Example :

The valve is **opened at 9.00 a.m. manually**, the opening period is 10 minutes. A program with a **start time between 9.00 and 9.10 a.m.** will not be undertaken in this case.

Reset :

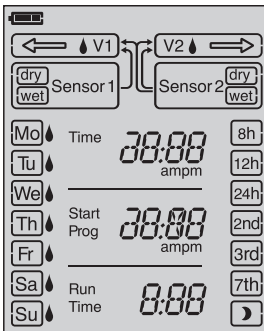

The factory settings are restored.

- Press **Man.**-key and **Menu**-key simultaneously for 3 seconds.
All the LCD symbols are displayed for 2 seconds and the display moves to the normal display.

- All the program data are set to zero.
- The manual watering period is set to **0:30** again.
- The time and day of the week are retained.

Important information :

If no entry is made during programming for a period of more than 60 seconds, the normal display reappears. In this case all changes made up till now will be applied.

If a sensor inserted in the Water Computer registers wet (**wet**), the corresponding programme will not be carried out.

6. Storage

Storage / Overwintering :



1. To preserve the battery, it should be removed (see 4. Initial Operation).

The programmes remain stored. If the battery is inserted again in spring, only the time of day and the weekday must be newly entered.

2. Store controller and valve unit in a dry place where they are protected from frost.

Disposal:
(in accordance with
RL2002/96/EC)



The product must not be added to normal household waste. It must be disposed of in line with local environmental regulations.
→ Important: Make sure that the unit is disposed of via your municipal recycling collection centre.

Disposing of flat batteries:

→ Please return flat batteries to a GARDENA dealer or dispose of them properly at your nearest recycling centre.
Only dispose of batteries when they are **flat**.

7. Maintenance

Clean filter:

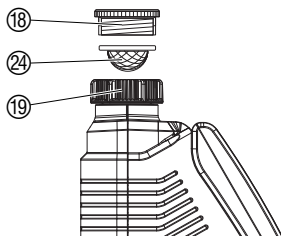

The filter 24 should be checked regularly and cleaned when necessary.

1. Unscrew sleeve nut 19 of the Water Computer by hand from the tap thread (do not use pliers).
2. If necessary unscrew the adaptor 18.
3. Remove filter 24 from sleeve nut 19 and clean.
4. Fit the Water Computer again (see 4. Putting Your Water Computer into Operation "Connecting Water Computer").

8. Troubleshooting

Fault	Possible Cause	Remedy
No display appears	Battery inserted incorrectly.	→ Check polarity markings match (+/-).
	Flat battery.	→ Insert new alkaline battery.
	Temperature on the display is higher than 60 °C.	Display appears after temperature has dropped.
Manual watering is not possible using the Man. button	Battery flat (frame is flashing).	→ Insert new alkaline battery.
	Manual watering period is set to 0:00.	→ Set manual watering period to a figure greater than 0:00 (see 5. Programming).
	Tap turned off.	→ Turn tap on.
Watering program is not carried out out (no watering)	Watering program has not been entered completely.	→ Read off watering program and modify if necessary.
	Programs deactivated (Prog. OFF).	→ Activate program (Prog. ON).
	Program entry/modification during or just before the start pulse.	→ Make program entry/modification outside the programmed start times.
	Valve was opened manually previously.	→ Avoid possible program overlaps.
	Tap turned off.	→ Turn tap on.
	Soil moisture or rain sensor registers damp (wet).	→ If dry, check setting/location of soil moisture/rain sensor.

Fault	Possible Cause	Remedy
Watering program is not carried out (no watering)	Battery flat (frame is flashing). Controller is not connected (no display with V1/V2).	→ Insert new alkaline battery. → Mount controller on housing.
Water Computer does not close	Minimum quantity of water drawn is less than 20 l/h.	→ Connect more drip heads.
Symbol direct sensor control is flashing 	Sensor is not correctly connected or not registered.	→ Check Connection Cable and sensor, or activate sensor.
Sensor 1 and/or Sensor 2 is flashing	Sensor is defective.	→ Check Connection Cable and sensor or deactivate sensor.



In the event of other faults please contact GARDENA Service.
Repairs should only be carried out by GARDENA service centres or dealers authorised by GARDENA.

9. Available accessories

GARDENA Soil Moisture Sensor		Art. No. 1188
GARDENA Rain Sensor electronic		Art. No. 1189
GARDENA Anti-theft device		Art. No. 1815-00.791.00 From GARDENA Service
GARDENA Adapter cable	To connect older GARDENA sensors	Art. No. 1189-00.600.45
GARDENA Cable Adapter	For simultaneous connection of Rain- and Soil Moisture Sensor	From GARDENA Service

10. Technical Data

Number of controlled valves:	2
Min./max. operating pressure:	0.5 bar / 12 bar
Flow medium:	Clear fresh water
Max. liquid temperature:	40 °C
Temperature area:	5 °C to 60 °C
Number of program-controlled watering cycles per valve and day:	3 x (every 8 hrs.), 2 x (every 12 hrs.), 1 x (every 24 hrs.)
Number of program-controlled watering cycles per valve and week:	Every day, every 2, 3 or 7 days; or individual selection of weekdays
Watering duration:	1 min. to 3 hours 59 min.
Battery required:	1 x 9V alkaline manganese alkaline battery type IEC 6LR61
Operating time of the battery:	approx. 1 year

11. Service / Warranty

GARDENA guarantees this product for 2 years (from date of purchase). This guarantee covers all serious defects of the unit that can be proved to be material or manufacturing faults.

Under warranty we will either replace the unit or repair it free of charge if the following conditions apply:

- The unit must have been handled properly and in keeping with the requirements of the operating instructions.
- Neither the purchaser or a non-authorised third party have attempted to repair the unit.
- Faults which occur as a result of incorrectly installed or leaking batteries are not covered by the guarantee.
- Damage caused by frost is not covered by the warranty.

This manufacturer's guarantee does not affect the user's existing warranty claims against the dealer/seller.

If you have any problems with your Water Computer, please contact our Customer Service or return the defective unit together with a short description of the problem directly to one of the GARDENA Service Centres listed on the back of this leaflet.

D Produkthaftung

Wir weisen ausdrücklich darauf hin, dass wir nach dem Produkthaftungsgesetz nicht für durch unsere Geräte hervorgerufene Schäden einzustehen haben, sofern diese durch unsachgemäße Reparatur verursacht oder bei einem Teileaustausch nicht unsere Original GARDENA Teile oder von uns freigegebene Teile verwendet werden und die Reparatur nicht vom GARDENA Service oder dem autorisierten Fachmann durchgeführt wird. Entsprechendes gilt für Ergänzungsstücke und Zubehör.

GB Product Liability

We expressly point out that, in accordance with the product liability law, we are not liable for any damage caused by our units if it is due to improper repair or if parts exchanged are not original GARDENA parts or parts approved by us, and, if the repairs were not carried out by a GARDENA Service Centre or an authorised specialist. The same applies to spare parts and accessories.

F Responsabilité

Nous vous signalons expressément que GARDENA n'est pas responsable des dommages causés par ses appareils, dans la mesure où ces dommages seraient causés suite à une réparation non conforme, dans la mesure où, lors d'un échange de pièces, les pièces d'origine GARDENA n'auraient pas été utilisées, ou si la réparation n'a pas été effectuée par le Service Après-Vente GARDENA ou l'un des Centres SAV agréés GARDENA. Ceci est également valable pour tout ajout de pièces et d'accessoires autres que ceux préconisés par GARDENA.

NL Productaansprakelijkheid

Wij wijzen er nadrukkelijk op, dat wij op grond van de wet aansprakelijkheid voor producten niet aansprakelijk zijn voor schade ontstaan door onze apparaten, indien deze door onvakkundige reparatie veroorzaakt zijn, of er bij het uitwisselen van onderdelen geen gebruik gemaakt werd van onze originele GARDENA onderdelen of door ons vrijgegeven onderdelen en de reparatie niet door de GARDENA technische dienst of de bevoegde vakman uitgevoerd werd. Ditzelfde geldt voor extra-onderdelen en accessoires.

I Responsabilità del prodotto

Si rende espressamente noto che, conformemente alla legislazione sulla responsabilità del prodotto, non si risponde di danni causati da nostri articoli se originati da riparazioni eseguite non correttamente o da sostituzioni di parti effettuate con materiale non originale GARDENA o comunque da noi non approvato e, in ogni caso, qualora l'intervento non venga eseguito da un centro assistenza GARDENA o da personale specializzato autorizzato. Lo stesso vale per le parti complementari e gli accessori.

E Responsabilidad de productos

Advertimos que conforme a la ley de responsabilidad de productos no nos responsabilizamos de daños causados por nuestros aparatos, siempre y cuando dichos daños hayan sido originados por arreglos o reparaciones indebidas, por recambios con piezas que no sean piezas originales GARDENA o bien piezas autorizadas por nosotros, así como en aquellos casos en que la reparación no haya sido efectuada por un Servicio Técnico GARDENA o por un técnico autorizado. Lo mismo es aplicable para las piezas complementarias y accesorios.

P Responsabilidade sobre o produto

Queremos salientar que segundo a lei da responsabilidade do fabricante, nós não nos responsabilizaremos por danos causados pelo nosso equipamento, quando estes ocorram em decorrência de reparações inadequadas ou da substituição de peças por peças não originais da GARDENA, ou peças não autorizadas. A responsabilidade tornar-se-á nula também depois de reparações realizadas por oficinas não autorizadas pela GARDENA. Esta restrição valerá também para peças adicionais e acessórios.

<p>D EG-Konformitätserklärung Der Unterzeichnete Husqvarna AB, 561 82 Huskvarna, Sweden bestätigt, dass die nachfolgend bezeichneten Geräte in der von uns in Verkehr gebrachten Ausführung die Anforderungen der harmonisierten EU-Richtlinien, EU-Sicherheitsstandards und produktspezifischen Standards erfüllen. Bei einer nicht mit uns abgestimmten Änderung der Geräte verliert diese Erklärung ihre Gültigkeit.</p>	<p>Bezeichnung des Gerätes: Bewässerungscomputer Description of the unit: Water Computer Désignation du matériel : Programmeur d'arrosage Omschrijving van het apparaat: Besproeiingscomputer Descrizione del prodotto: Computer per irrigazione Descripción de la mercancía: Programador de riego Descrição do aparelho: Computador de rega</p>
<p>GB EU Declaration of Conformity The undersigned Husqvarna AB, 561 82 Huskvarna, Sweden, hereby certifies that, when leaving our factory, the units indicated below are in accordance with the harmonised EU guidelines, EU standards of safety and product specific standards. This certificate becomes void if the units are modified without our approval.</p>	<p>Typ: Art.-Nr.: Type: Art. No.: Type : C 2030 Référence : Typ: duo plus Art. nr.: 1874 Modello: Art. : Tipo: Art. Nº: Tipo: Art. Nº:</p>
<p>F Certificat de conformité aux directives européennes Le constructeur, soussigné : Husqvarna AB, 561 82 Huskvarna, Sweden, déclare qu'à la sortie de ses usines le matériel neuf désigné ci-dessous était conforme aux prescriptions des directives européennes énoncées ci-après et conforme aux règles de sécurité et autres règles qui lui sont applicables dans le cadre de l'Union européenne. Toute modification portée sur ce produit sans l'accord express de Husqvarna supprime la validité de ce certificat.</p>	<p>EU-Richtlinien : EU directives : 2006/42/EC Directives européennes : 2004/108/EC EU-richtlijnen : 93/68/EC Directive UE : Normativa UE : Directrices da UE :</p>
<p>NL EU-overeenstemmingsverklaring Ondergetekende Husqvarna AB, 561 82 Huskvarna, Sweden, bevestigt, dat het volgende genoemde apparaat in de door ons in de handel gebrachte uitvoering voldoet aan de eis van, en in overeenstemming is met de EU-richtlijnen, de EU-veiligheidsstandaard en de voor het product specifieke standaard. Bij een niet met ons afgestemde verandering aan het apparaat verliest deze verklaring haar geldigheid.</p>	<p>Harmonisierte EN: DIN EN ISO 12100</p>
<p>I Dichiarazione di conformità alle norme UE La sottoscritta Husqvarna AB, 561 82 Huskvarna, Sweden, certifica che il prodotto qui di seguito indicato, nei modelli da noi commercializzati, è conforme alle direttive armonizzate UE nonché agli standard di sicurezza e agli standard specifici di prodotto. Qualunque modifica apportata al prodotto senza nostra specifica autorizzazione invalida la presente dichiarazione.</p>	<p>Hinterlegte Dokumentation: GARDENA Technische Dokumentation E. Renn 89079 Ulm Deposited Documentation: GARDENA Technical Documentation E. Renn 89079 Ulm Documentation déposée : Documentation technique GARDENA E. Renn 89079 Ulm</p>
<p>E Declaración de conformidad de la UE El que suscribe Husqvarna AB, 561 82 Huskvarna, Sweden, declara que la presente mercancía, objeto de la presente declaración, cumple con todas las normas de la UE, en lo que a normas técnicas, de homologación y de seguridad se refiere. En caso de realizar cualquier modificación en la presente mercancía sin nuestra previa autorización, esta declaración pierde su validez.</p>	<p>Anbringungsjahr der CE-Kennzeichnung: Year of CE marking: Date d'apposition du marquage CE : 2011 Installatiejaar van de CE-aanduiding: Anno di rilascio della certificazione CE: Colocación del distintivo CE: Ano de marcação pela CE:</p>
<p>P Certificado de conformidade da UE Os abaixo mencionados Husqvarna AB, 561 82 Huskvarna, Sweden, por este meio certificam que ao sair da fábrica o aparelho abaixo mencionado está de acordo com as directrizes harmonizadas da UE, padrões de segurança e de produtos específicos. Este certificado ficará nulo se a unidade for modificada sem a nossa aprovação.</p>	<p>Ulm, den 14.07.2011 Der Bevollmächtigte Ulm, 14.07.2011 Authorised representative Ulm, 14-07-2011 Représentant légal Ulm, 14-07-2011 Gemachtigde Ulm, 14.07.2011 Rappresentante autorizzato Ulm, 14.07.2011 Representante autorizado Ulm, 14.07.2011 Representante autorizado</p> <p> A. Disch Vice President Category Watering</p>

Deutschland / Germany

GARDENA GmbH
Central Service
Hans-Lorenser-Straße 40
D-89079 Ulm
Produktfragen:
(+49) 731 490-123
Reparaturen:
(+49) 731 490-290
service@gardena.com

Albania

COBALT Sh.p.k.
Rr. Siri Kodra
1000 Tirana

Argentina

Husqvarna Argentina S.A.
Av.del Libertador 5954 -
Piso 11 - Torre B
(C1428ARP) Buenos Aires
Phone: (+54) 11 5194 5000
info.gardena@
ar.husqvarna.com

Armenia

Garden Land Ltd.
61 Tigran Mets
0005 Yerevan

Australia

Husqvarna Australia Pty. Ltd.
Locked Bag 5
Central Coast BC
NSW 2252
Phone: (+61) (0) 2 4352 7400
customer.service@
husqvarna.com.au

Austria / Österreich

Husqvarna Austria GmbH
Consumer Products
Industriezeile 36
4010 Linz
Tel.: (+43) 732 77 01 01 - 90
consumer.service@
husqvarna.at

Azerbaijan

Firm Progress a.
Aliyev Str. 26A
10522 Baku

Belgium

GARDENA Belgium NV/SA
Sterrebeekstraat 163
1930 Zaventem
Phone: (+32) 2 720 92 12
Mail: info@gardena.be

Bosnia / Hercegovina

SILK TRADE d.o.o.
Industrijska zona Bukva bb
74260 Tešanj

Brazil

Husqvarna do Brasil Ltda
Av. Francisco Matrazzo,
1400 - 19º andar
São Paulo - SP
CEP: 05001-903
Tel: 0800-112252
marketing.br.husqvarna@
husqvarna.com.br

Bulgaria

Хускварна България ЕООД
Бул. „Андрей Ляпчев“ № 72
1799 София
Tel.: (+359) 02/9753076
www.husqvarna.bg

Canada / USA

GARDENA Canada Ltd.
100 Summerlea Road
Brampton, Ontario L6T 4X3
Phone: (+1) 905 792 9330
info@gardena.canada.com

Chile

Maquinarias Agroforestales
Ltda. (Maga Ltda.)
Santiago, Chile
Avda. Chesterton
8355 comuna Las Condes
Phone: (+56) 2 202 4417
Dalton@мага.cl
Zipcode: 7560330

Temuco, Chile

Avda. Valparaiso # 01466
Phone: (+56) 45 222 126
Zipcode: 4780441

China

Husqvarna (China) Machinery
Manufacturing Co., Ltd.
No. 1355, Jia Xin Rd.,
Ma Lu Zhen, Jia Ding Dist.,
Shanghai
201801
Phone: (+86) 21 59159629
Domestic Sales
www.gardena.com.cn

Colombia

Husqvarna Colombia S.A.
Calle 18 No. 68 D-31, zona
Industrial de Montevideo
Bogotá, Cundinamarca
Tel. 571 2922700 ext. 105
jairo.salazar@
husqvarna.com.co

Costa Rica

Europa Exim
Euroiberamericana S.A.
Los Colegios, Moravia,
200 metros al Sur del Colegio
Saint Francis - San José
Phone: (+506) 297 68 83
exim_euro@racsa.co.cr

Croatia

SILK ADRIA d.o.o.
Josipa Lončara 3
10090 Zagreb
Phone: (+385) 1 3794 580
silk.adria@zg-t.com.hr

Cyprus

Med Marketing
17 Digeni Akritas Ave
P.O. Box 27017
1641 Nicosia

Czech Republic

Husqvarna Česko s.r.o.
Türkova 2319/5b
149 00 Praha 4 – Chodov
Bežplatná infolinka:
800 100 425
servis@cz.husqvarna.com

Denmark

GARDENA / Husqvarna
Consumer Outdoor Products
Salgsafdelning Danmark
Box 9003
S-200 39 Malmö
info@gardena.dk

Dominican Republic

BOSQUESA, S.R.L.
Carretera Santiago Licey
Km. 5 ½
Esquina Copal II.
Santiago, Dominican Republic
Phone: (+809) 736-0333
joserbosquesa@claro.net.do

Ecuador

Husqvarna Ecuador S.A.
Arujos E1-181 y 10 de Agosto
Quito, Pichincha
Tel: (+593) 22800739
francisco.jacom@
husqvarna.com.ec

Estonia

Husqvarna Eesti OÜ
Consumer Outdoor Products
Kesk tee 10, Aaviku küla
Rae vald
Harju maakond
75005 Estonia
kontakt.etj@husqvarna.ee

Finland

Oy Husqvarna Ab
Consumer Outdoor Products
Lautatarhankatu 8 / PL 3
00581 HELSINKI
info@gardena.fi

France

GARDENA France
Immeuble Expositif
9 - 11 allée des Pierres Mayettes
Zac des Barbantiers, B.P. 99
F - 92232 GENNEVILLIERS
cedex
Tél. (+33) 01 40 85 30 40
service.consommateurs@
gardena.fr

Georgia

ALD Group
Belashvili 8
1159 Tbilisi

Great Britain

Husqvarna UK Ltd
Preston Road
Aycliffe Industrial Park
Newton Aycliffe
County Durham
DL5 6UP
info.gardena@
husqvarna.co.uk

Greece

HUSQVARNA ΕΛΛΑΣ Α.Ε.Β.Ε.
Υπ. /μ Ηρόδιου 33Α
Βρ. Πλ. Κορωπίου
194 00 Κορωπί Αττικής
V.A.T. EL094094640
Phone: (+30) 210 6620 225
info@husqvarna-consumer.gr

Hungary

Husqvarna Magyarország Kft.
Ezred u. 1-3
1044 Budapest
Telephone: (+36) 1 251-4161
vevozszoigalat.husqvarna@
husqvarna.hu

Iceland

O. Johnson & Kaaber
Tunguhalsi 1
110 Reykjavik
ooj@oik.is

Ireland

Husqvarna UK Ltd
Preston Road
Aycliffe Industrial Park
Newton Aycliffe
County Durham
DL5 6UP
info.gardena@
husqvarna.co.uk

Italy

Husqvarna Italia S.p.A.
Via Como 72
23868 VALMADRERA (LC)
Phone: (+39) 0341.203.111
info@gardenaitalia.it

Japan

KAKIUCHI Co. Ltd.
Sumitomo Realty &
Development Kojimachi
BLDG., 8F
5-1 Nibanncyo
Chiyoda-ku
Tokyo 102-0084
Phone: (+81) 33264 7271
m_ishihara@kaku-ichi.co.jp

Kazakhstan

LAMED Ltd.
155/11, Tazhibayevy Str.
050060 Almaty
IP Schmidt
Abayavenue 3B
110 005 Kostanay

Kyrgyzstan

Alye Maki
av. Molodaya Guardir J 3
720014
Bishkek

Latvia

Husqvarna Latvija
Consumer Outdoor Products
Bakūži iela 6
LV-1024 Rīga
info@husqvarna.lv

Lithuania

UAB Husqvarna Lietuva
Consumer Outdoor Products
Ateities pl. 77C
LT-52104 Kaunas
centras@husqvarna.lt

Luxembourg

Magasins Jules Neuberg
39, rue Jacques Stas
Luxembourg-Gaspersch 2549
Case Postale No.12
Luxembourg 2010
Phone: (+352) 40 140 101
api@neuberg.lu

Mexico

AFOSA
Av Lopez Mateos Sur # 5019
Col. La Palma 45070
Zapopan, Jalisco
Mexico
Phone: (+52) 33 3818-3434
icornejo@afosa.com.mx

Moldova

Convel S.R.L.
290A Muncestri Str.
2002 Chisinau

Netherlands

GARDENA Nederland B.V.
Postbus 50176
1305 AD ALMERE
Phone: (+31) 36 521 00 00
info@gardena.nl

Neth. Antilles

Jonka Enterprises N.V.
Sta. Rosa Weg 196
P.O. Box 8200
Curaçao
Phone: (+599) 9 767 66 55
pgm@jonka.com

New Zealand

Husqvarna New Zealand Ltd.
PO Box 76-437
Manukau City 2241
Phone: (+64) (0) 9 9202410
support.nz@husqvarna.co.nz

Norway

GARDENA
Husqvarna Consumer
Outdoor Products
Salgskontor Norge
Klevereivn 6
1540 Vestby
info@gardena.no

Peru

Husqvarna Perú S.A.
Jr. Ramón Cárcamo 710
Lima 1
Tel: (+51) 1 3320400 ext. 416
juan_remuigo@
husqvarna.com

Poland

Husqvarna
Poland Spółka z o.o.
ul. Wysockiego 15 b
03-371 Warszawa
Phone: (+48) 22 330 96 00
gardena@gardena.pl

Portugal

Husqvarna Portugal, SA
Lagoa - Albarraque
2635 - 595 Rio de Mouro
Tel: (+351) 21 922 85 30
Fax: (+351) 21 922 85 36
info@gardena.pt

Romania

Madex International Srl
Soseaua Odaii 117 - 123,
RO 013603
București, S1
Phone: (+40) 21 352.76.03
madex@mes.ro

Russia

ООО „Хускварна“
141400, Московская обл.,
г. Химки,
улица Ленинградская,
владение 39, стр.6
Бизнес Центр
„Химки Бизнес Парк“,
помещение ОВ02_04

Serbia

Domel d.o.o.
Autoput za Novi Sad bb
11273 Belgrade
Phone: (+381) 11 848 88 12
miroslav.jejina@domel.rs

Singapore

Hy-Ray PRIVATE LIMITED
40 Jalan Pemimpin
02-028 Tat Ann Building
Singapore 577185
Phone: (+65) 6253 2277
shiyang@hyray.com.sg

Slovak Republic

Husqvarna Česko s.r.o.
Türkova 2319/5b
149 00 Praha 4 – Chodov
Bežplatná infolinka:
800 154 044
servis@sk.husqvarna.com

Slovenia

Husqvarna Austria GmbH
Consumer Products
Industriezeile 36
4010 Linz
Tel.: (+43) 732 77 01 01 - 90
consumer.service@
husqvarna.at

South Africa

Husqvarna
South Africa (Pty) Ltd
Postnet Suite 250
Private Bag X6,
Cascades, 3202
South Africa
Phone: (+27) 33 846 9700
info@gardena.co.za

Spain

Husqvarna España S.A.
C/ Basauri, nº 6
La Florida
28023 Madrid
Phone: (+34) 91 708 05 00
atencioncliente@gardena.es

Suriname

Agrofix n.v.
Verlengde Hogestraat #22
Phone: (+597) 472426
agrofix@sr.net
Pobox : 2006
Paramaribo
Suriname-South America

Sweden

Husqvarna AB
S-561 82 Huskvarna
info@gardena.se

Switzerland / Schweiz

Husqvarna Schweiz AG
Consumer Products
Industriestrasse 10
5506 Mägenwil
Phone: (+41) (0) 848 800 464
info@gardena.ch

Turkey

GARDENA Dost Diş Ticaret
Müesseslik A.Ş.
Sanayi Cad. Adil Sokak
No: 1/B Kartal
34873 Istanbul
Phone: (+90) 216 38 93 939
info@gardena-dost.com.tr

Ukraine / Україна

TOB «Хусарна Україна»
вул. Васильківська, 34,
офіс 204-г
03022, Київ
Tel: (+38) 044 498 39 02
info@gardena.ua

Uruguay

FELI SA
Entre Ríos 1083 CP 11800
Montevideo - Uruguay
Tel: (+598) 22 03 18 44
info@felisa.com.uy

Venezuela

Corporación Casa y Jardín C.A.
Av. Caroní, Edif. Trezmen, PB.
Colinas de Bello Monte,
1050 Caracas.
Tlf: (+58) 212 992 33 22
info@casayjardin.net.ve

1874-20.960.02/0112

© GARDENA
Manufacturing GmbH
D-89070 Ulm
http://www.gardena.com