



**OWNER'S MANUAL**



**CHAIN SAWS**

**G2500**

Original Language

**⚠ WARNING ⚠**

 Before using our products, please read this manual carefully to understand the proper use of your unit.

## EXPLANATION OF SYMBOLS AND SAFETY WARNINGS



Read operator's instruction book before operating this machine.



Wear head, eye and ear protection.



Use the chain saw with two hands.



Warning! Danger of kickback.



Read, understand and follow all warnings.



Use appropriate protections for foot-leg and hand-arm.



Never touch hot surface.





This saw is for trained tree service operators only.

### G2500



**WARNING!!!**  
**RISK OF DAMAGING HEARING**  
Wear head, eye and ear protection.





MODEL	DISPLACEMENT	SOUND LEVEL		VIBRATION LEVEL			
		ISO 22868	2000/14/EC	ISO 22867		2002/44/EC	
		L <sub>pA</sub>	L <sub>wA</sub>	Front handle	Rear handle	A (8)	
						Front handle	Rear handle
G2500	25.4cm <sup>3</sup>	96.0 dB(A)	110 dB(A)	6.3 m/s <sup>2</sup>	4.6 m/s <sup>2</sup>	3.5 m/s <sup>2</sup>	2.5 m/s <sup>2</sup>

Vibration level has the error margin of ±10%.

**APPROVAL NUMBER OF CE EXHAUST EMISSION REGULATION (2002/88/EC)**  
**e13\*97/68SH2G3\*2002/88\*0085\*07**

**EC DECLARATION OF CONFORMITY**

to Directive 2006/42/EC on machinery and to Directive 2004/108/EC on electromagnetic compatibility and to the regulations governing transposition internal control production.

Manufacturer : Husqvarna Zenoah Co., Ltd.  
1-9 Minamidai, Kawagoe, Saitama, Japan

DECLARES THAT THE DESIGN OF THE MACHINE DESCRIBED BELOW.

Description : Chain Saw  
Model : G2500  
Serial no. : 2010 000001 and up  
Make : Husqvarna Zenoah

CONFORMS TO THE REQUIREMENTS OF THE MACHINERY DIRECTIVE (Directive 2006/42/EC) AND TO THE NATIONAL REGULATIONS GOVERNING ITS TRANSPOSITION ABROAD : AND

THAT IT HAS BEEN ISSUED WITH A CE CERTIFICATE (NO. M3 2992703 01) by TUV Rheinland Group - TUV Rheinland InterCert kft. Product Certification. H-1061 Budapest, Paulay Ede u. 52, Hungary

Date : 29 December 2009

Signature :



Kiyoshi Honda  
General Manager, Development Center

Authorised representative :  
ZENOAH EUROPE B.V.  
Jool Hulstraat 20-22, 1327 HA Almere, The Netherlands  
Person authorised to compile the technical file :  
Fred ter Beek  
Jool Hulstraat 20-22, 1327 HA Almere, The Netherlands

## Contents

1. For Safe Operation .....	4
2. Explanation of Symbols on the Machine .....	8
3. Installing Guide Bar and Saw Chain .....	9
4. Fuel and Chain Oil .....	10
5. Operating the Engine .....	11
6. Sawing .....	13
7. Maintenance .....	15
8. Maintenance of Saw Chain and Guide Bar .....	16
9. Troubleshooting Guide .....	17
10. Disposal .....	17
11. Specifications .....	18
12. Limited Warranty .....	19

# 1. For safe operation

## ▲ WARNING

This chainsaw has been especially designed for tree maintenance and should therefore only be used by trained operators when working on trees.



1. Never operate a chain saw when you are fatigued, ill, or upset, or under the influence of medication that may make you drowsy, or if you are under the influence of alcohol or drugs.

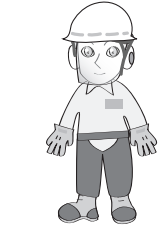

2. Use safety footwear, snug fitting clothing and eye, hearing and head protection devices. Use the vibration-proof glove.



3. Keep the saw chain sharp and the saw, including the AV system, well maintained. A dull chain will increase cutting time, and pressing a dull chain through wood will increase the vibrations transmitted to your hands. A saw with loose components or with damaged or worn AV buffers will also tend to have higher vibration levels.

4. Always use caution when handling fuel. Wipe up all spills and then move the chain saw at least 3 m from the fueling point before starting the engine.



5. Eliminate all sources of sparks or flame (i.e. smoking, open flames, or work that can cause sparks) in the areas where fuel is mixed, poured, or stored.

6. Do not smoke while handling fuel or while operating the chain saw.

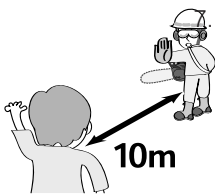

Do not allow other persons to be near the chain saw when starting or cutting. Keep bystanders and animals out of the work area. Children, pets and bystanders should be a minimum of 10 m away when you start or operate the chain saw.

8. Never start cutting until you have a clear work area, secure footing, and a planned retreat path from the falling tree.

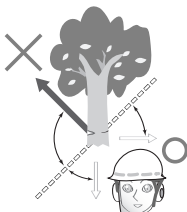

9. Always hold the chain saw firmly with both hands when the engine is running. Use a firm grip with thumb and fingers encircling the chain saw handles.

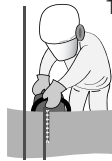

10. Keep all parts of your body away from the saw chain when the engine is running.



11. Before you start the engine, make sure the saw chain is not contacting anything.

12. Always carry the chain saw with the engine stopped, the guide bar and saw chain to the rear, and the muffler away from your body.

13. Always inspect the chain saw before each use for worn, loose, or damaged parts. Never operate a chain saw that is damaged, improperly adjusted, or is not completely and securely assembled. Be sure that the saw chain stops moving when the throttle control trigger is released.



14. All chain saw service, other than the items listed in the Owner's Manual, should be performed by competent chain saw service personnel. (E.g., if improper tools are used to remove the flywheel, or if an improper tool is used to hold the flywheel in order to remove the clutch, structural damage to the flywheel could occur which could subsequently cause the flywheel to disintegrate.)



15. Always shut off the engine before setting it down.

16. Use extreme caution when cutting small size brush and saplings because slender material may catch the saw chain and be whipped toward you or pull you off balance.



17. When cutting a limb that is under tension, be alert for spring-back so that you will not be struck when the tension in the wood fibers is released.

18. Never cut in high wind, bad weather, when visibility is poor or in very high or low temperatures. Always check the tree for dead branches which could fall during the felling operation.

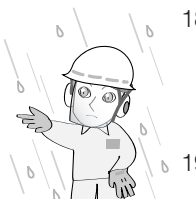

19. Keep the handles dry, clean and free of oil or fuel mixture.



20. Operate the chain saw only in well ventilated areas. Never start or run the engine inside a closed room or building. Exhaust fumes contain dangerous carbon monoxide.

21. Do not operate the chain saw in a tree unless specially trained to do so.



22. Guard against kickback. Kickback is the upward motion of the guide bar which occurs when the saw chain at the nose of the guide bar contacts an object. Kickback can lead to dangerous loss of control of the chain saw.

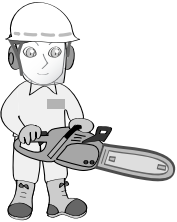

23. When transporting your chain saw, make sure the appropriate guide bar scabbard is in place.

24. Never touch the muffler guard, guide bar, saw chain or nut with bare hands while the engine is in operation or immediately after shutting down the engine. Doing so could result in serious burns because of high temperature.

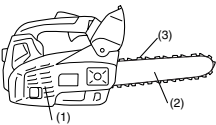

- (1) muffler guard  
(2) guide bar  
(3) saw chain

### KICKBACK SAFETY PRECAUTIONS FOR CHAIN SAW USERS

#### ⚠ WARNING



- Kickback may occur when the nose or tip of the guide bar touches an object, or when the wood closes in and pinches the saw chain in the cut. Tip contact in some cases may cause a lightning fast reverse reaction, kicking the guide bar up and back towards the operator. Pinching the saw chain along the top of the guide bar may push the guide bar rapidly back towards the operator. Either of these reactions may cause you to lose control of the saw, which could result in serious personal injury.
- Do not rely exclusively on the safety devices built into your saw. As a chain saw user you should take several steps to keep cutting jobs free from accident or injury.



- (1) With a basic understanding of kickback you can reduce or eliminate the element of surprise. Sudden surprise contributes to accidents.
- (2) Keep a good grip on the saw with both hands, the right hand on the rear

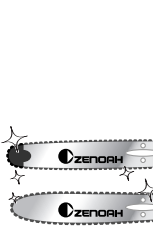

handle, and the left hand on the front handle, when the engine is running. Use a firm grip with thumbs and fingers encircling the chain saw handles. A firm grip will help you reduce kickback and maintain control of the saw.

(3) Make certain that the area in which you are cutting is free from obstructions. Do not let the nose of the guide bar contact a log, branch, or any other obstruction which could be hit while you are operating the saw.

(4) Cut at high engine speeds.

(5) Do not overreach or cut above shoulder height.

(6) Follow the manufacturer's sharpening and maintenance instructions for the saw chain.

(7) Only use replacement bars and chains specified by the manufacturer or the equivalent.



### WORSE EFFECTS OF VIBRATION

If you continue to use high-vibration tools these symptoms will probably get worse, for example:

- the numbness in your hands could become permanent and you won't be able to feel things at all;
- you will have difficulty picking up small objects such as screws or nails;
- the vibration white finger could happen more frequently and affect more of your fingers.

### FOR PROTECTING YOUR BODY FROM VIBRATION

Please observe the following matter, in order to protect the health of your body.

1. Always use the right tool for each job (to do the job more quickly and expose you to less hand-arm vibration).
2. Check tools before using them to make sure they have been properly maintained and repaired to avoid increased vibration caused by faults or general wear.
3. Make sure cutting tools are kept sharp so that they remain efficient.
4. Reduce the amount of time you use a tool in one go, by doing other jobs in between.
5. Avoid gripping or forcing a tool or workpiece more than you have to.
6. Store tools so that they do not have very cold handles when next used.
7. Encourage good blood circulation by:
  - keeping warm and dry (when necessary, wear gloves, a hat, waterproofs and use heating pads if available);
  - giving up or cutting down on smoking because smoking reduces blood flow; and massaging and exercising your fingers

### DISPOSAL

- When you dispose of the machine, do not disassemble the machine.
- When you dispose of the machine, fuel, chain oil, be sure to follow your local regulations.

## WORKING WITH TREE SERVICE CHAIN-SAWS FROM A ROPE AND HARNESS

This chapter sets out working practices to reduce the risk of injury from tree service chainsaws when working at height from a rope and harness. While it may form the basis of guidance and training literature, it should not be regarded as a substitute for formal training.

### General requirements working at height

Operators of tree service chainsaws working at height from a rope and harness should never work alone. A competent ground worker trained in appropriate emergency procedures should assist them.

Operators of tree service chainsaws for this work should be trained in general safe climbing and work positioning techniques and shall properly equipped with harnesses, ropes, strops, karabiners and other equipment for maintaining secure and safe working positions for both themselves and the saw.

### Preparing to use the saw in the tree

The chainsaw should be checked, fuelled, started and warmed up by the ground worker before it is sent up to the operator in the tree. The chainsaw should be fitted with a suitable strop for attaching to the operator's harness:



- a) choke the strop around the attachment point on the rear of the saw (A);

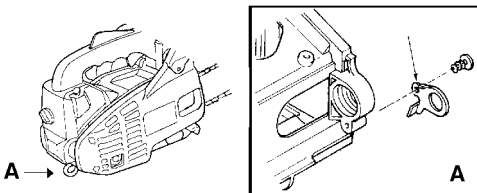

- b) provide suitable karabiners to allow indirect (i.e. via the strop) and direct attachment (i.e. at the attachment point on the saw) of saw to the operators harness;
- c) ensure the saw is securely attached when it is being sent up to the operator;
- d) ensure the saw is secured to the harness before it is disconnected from the means of ascent.

The saw should only be attached to the recommended attachment points on the harness. These may be at mid-point (front or rear) or at the sides. Where possible attaching the saw to centre rear mid-point will keep it clear of climbing lines and support its weight centrally down the operator's spine.



When moving the saw from any attachment point to another, operators should ensure it is secured in the new position before releasing it from the previous attachment point.

### Using the chainsaw in the tree

An analysis of accidents with these saws during tree service operations shows the primary cause as being inappropriate one-handed use of the saw. In the vast majority of accidents, operators fail to adopt a secure work position which allows them to hold both handles of the saw. This results in an increased risk of injury due to:

- not having a firm grip on the saw if it kicks back;
- a lack of control of the saw such that it is more liable to contact climbing lines and operators body (particularly the left hand and arm)
- losing control from insecure work position resulting in contact with the saw (unexpected movement during operation of the saw)

### Securing the work position for two-handed use

To allow the operator to hold the saw with both hands, they should as general rule, aim for secure work position where they are operating the saw at:

- hip level when cutting horizontal sections;
- solar plexus level when cutting vertical sections.

Where the operator is working close into vertical stems with a low lateral forces on their work position, then a good footing may be all that is needed to maintain a secure work position. However as operators move away from the stem, they will need to take steps to remove or counteract the increasing lateral forces by, for example, a re-direct of the main line via a supplementary anchor point or using an adjustable strop direct from the harness to a supplementary anchor point.



Gaining a good footing at the working position can be assisted by use of a temporary foot stirrup created from an endless sling.



### Starting the saw in the tree

When starting the saw in the tree, the operator should:

- a) apply the chain brake before starting;
- b) hold saw on either the left or right of the body when starting:
  - 1) on the left side hold the saw with either the left hand on the front handle or the right hand on the rear handle and thrust the saw away from the body while holding the pull starter cord in the other hand;
  - 2) on the right side, hold the saw with the right hand on either handle and thrust the saw away from the body while holding the pull starter cord in the left hand.

The chain brake should always be engaged before lowering a running saw onto its stop.

Operators should always check the saw has sufficient fuel before undertaking critical cuts.

### One-hand use of the chainsaw

Operators should not use tree service chainsaws one-handed in place of unstable work positioning or in preference to a handsaw when cutting small diameter wood at the branch tips.

Tree service chainsaws should only be used one-handed where:

- the operator cannot gain a work position enabling two-handed use; and
- they need to support their working position with one hand; and
- the saw is being used at full stretch, at right angles to and out of line with the operator's body.



Operators should never:

- cut with the kickback zone at the tip of the chainsaw guide bar
- 'hold and cut' sections
- attempt to catch falling sections.

### Freeing a trapped saw

If the saw should become trapped during cutting, operators should:

- switch off the saw and attach it securely to the tree inboard (i.e. towards the truck side) of the cut or to a separate tool line;
- pull the saw from the kerf whilst lifting the branch as necessary;
- if necessary, use a handsaw or second chain saw to release the trapped saw by cutting a minimum of 30 cm away from the trapped saw.

Whether a handsaw or a chainsaw is used to free a stuck saw, the release cuts should always be outboard (toward the tips of the branch), in order to prevent the saw being taken with the section and further complicating the situation.

## 2. Explanation of Symbols on the Machine

**▲ WARNING** For safe operation and maintenance, symbols are carved in relief on the machine. According to these indications, please be careful not to make any mistake.



The port to refuel "MIX GASOLINE"  
**Position:** Fuel cap



The port to top up chain oil  
**Position:** Oil cap



Setting the switch to the "O" position, the engine stops immediately.  
**Position:** Front at the top of the rear handle



Starting the engine. If you pull out the choke knob (at the back-right of the rear handle) to the point of the arrow, you can set the starting mode as follows:

- *First-stage position* – starting mode when the engine is warm.
- *Second-stage position* – starting mode when the engine is cold.

**Position:** Upper-right of the aircleaner cover



The screw under the "H" stamp is The High-speed adjustment screw.  
 The screw under the "L" stamp is The Slow-speed adjustment screw.  
 The screw at the left of the "T" stamp is the Idle adjustment screw.  
**Position:** Left side of the rear handle



Shows the directions that the chain brake is released (white arrow) and activated (black arrow).  
**Position:** Front of the chain cover

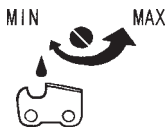

If you turn the rod by screwdriver follow the arrow to the "MAX" position, the chain oil flow more, and if you turn to the "MIN" position, less.  
**Position:** Bottom of the power unit



### 3. Installing Guide Bar and Saw Chain

A standard saw unit package contains the items as illustrated.

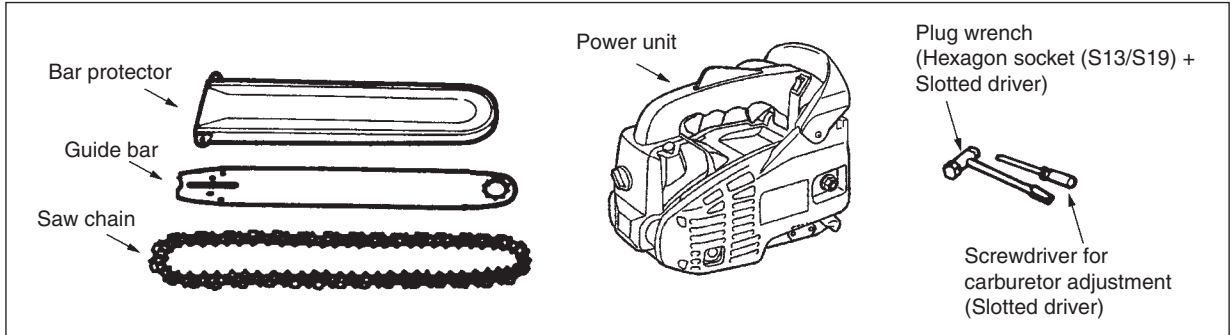

Open the box and install the guide bar and the saw chain on the power unit as follows:

#### **WARNING**

The saw chain has very sharp edges. Use thick protective gloves for safety.

1. Pull the guard towards the front handle to check that the chain brake is not engaged.
2. Loosen the nuts and remove the chain cover.
3. Fix the hanger on the rear of power unit by screw.

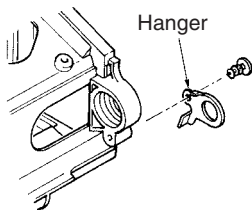

4. Mount the guide bar then fit the saw chain around the bar and sprocket.

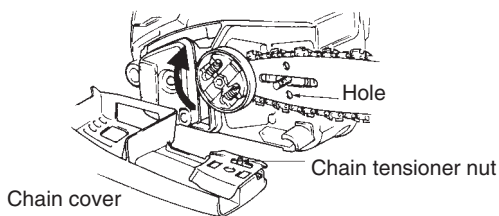

#### **NOTE**

Pay attention to the correct direction of the saw chain.

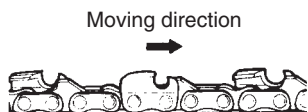

5. Fit the chain tensioner nut into the lower hole of the guide bar, then install the chain cover, and fasten the mounting nut to finger tightness.

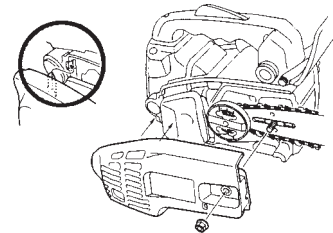

#### **WARNING**

When installing the chain cover, be sure to fit the hook completely at the rear end of the cover.

6. While holding up the tip of the bar, adjust the chain tension by turning the tensioner screw until the tie straps just touch the bottom side of the bar rail.

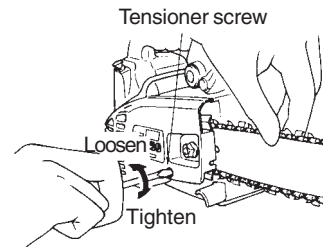

7. Tighten the nuts securely with the bar tip held up (11.8-14.7 N.m./120-150 kg-cm). Then check the chain for smooth rotation and proper tension while moving it by hand. If necessary, readjust with the chain cover loose.

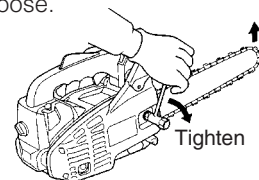

8. Tighten the tensioner screw.

#### **WARNING**

A new chain will expand its length in the beginning of use. Check and readjust the tension frequently as a loose chain can easily derail or cause rapid wear of itself and the guide bar.

## 4. Fuel and Chain Oil

### ■ FUEL

#### ▲ WARNING

- Gasoline is very flammable. Avoid smoking or bringing any flame or sparks near fuel. Make sure to stop the engine and allow it cool before refueling the unit. Select outdoor bare ground for fueling and move at least 3 m (10 ft) away from the fueling point before starting the engine.



- The Zenoah engines are lubricated by oil specially formulated for air-cooled 2-cycle gasoline engine use. If Zenoah oil is not available, use an anti-oxidant added quality oil expressly labeled for air-cooled 2-cycle engine use (JASO FC GRADE OIL or ISO EGC GRADE).
- Do not use BIA or TCW (2-stroke water-cooling type) mixed oil.

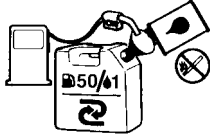

### ■ RECOMMENDED MIXING RATIO GASOLINE 50 : OIL 1 <when using ZENOAH genuine oil>

- Exhaust emission are controlled by the fundamental engine parameters and components (eq., carburation, ignition timing and port timing) without addition of any major hardware or the introduction of an inert material during combustion.
- These engines are certified to operate on unleaded gasoline.
- Make sure to use gasoline with a minimum octane number of 89RON (USA/Canada: 87AL).
- If you use a gasoline of a lower octane value than prescribed, there is a danger that the engine temperature may rise and an engine problem such as piston seizing may consequently occur.
- Unleaded gasoline is recommended to reduce the contamination of the air for the sake of your health and the environment.
- Poor quality gasolines or oils may damage sealing rings, fuel lines or fuel tank of the engine.

### ■ HOW TO MIX FUEL

#### ▲ WARNING

- Pay attention to agitation.
- Measure out the quantities of gasoline and oil to be mixed.
  - Put some of the gasoline into a clean, approved fuel container.
  - Pour in all of the oil and agitate well.
  - Pour in the rest of gasoline and agitate again for at least one minute. As some oils may be difficult to agitate depending on oil ingredients, sufficient agitation is necessary for the engine to last long. Be careful that, if the agitation is insufficient, there is an increased danger of early piston seizing due to abnormally lean mixture.
  - Put a clear indication on the outside of the container to avoid mixing up with gasoline or other containers.
  - Indicate the contents on outside of container for easy identification.

tification.

### ■ FUELING THE UNIT

- Untwist and remove the fuel cap. Rest the cap on a dustless place.
- Put fuel into the fuel tank to 80% of the full capacity.
- Fasten the fuel cap securely and wipe up any fuel spillage around the unit.

#### ▲ WARNING

- Select bare ground for fueling.
- Move at least 10 feet (3 meters) away from the fueling point before starting the engine.
- Stop the engine before refueling the unit. At that time, be sure to sufficiently agitate the mixed gasoline in the container.

### ■ FOR YOUR ENGINE LIFE, AVOID:

- FUEL WITH NO OIL (RAW GASOLINE) – It will cause severe damage to the internal engine parts very quickly.
- GASOHOL – It can cause deterioration of rubber and/or plastic parts and disruption of engine lubrication.
- OIL FOR 4-CYCLE ENGINE USE – It can cause spark plug fouling, exhaust port blocking, or piston ring sticking.
- Mixed fuels which have been left unused for a period of one month or more** may clog the carburetor and result in the engine failing to operate properly.
- In the case of storing the product for a long period of time, clean the fuel tank after rendering it empty. Next, activate the engine and empty the carburetor of the composite fuel.
- In the case of scrapping the used mixed oil container, scrap it only at an authorized repository site.

#### 📖 NOTE

As for details of quality assurance, read the description in the section Limited Warranty carefully. Moreover, normal wear and change in product with no functional influence are not covered by the warranty. Also, be careful that, if the usage in the instruction manual is not observed as to the mixed gasoline, etc. described therein, it may not be covered by the warranty.

### ■ SUPPLYING CHAIN OIL

#### ▲ WARNING

Running the equipment for long hours with its chain oil run out will accelerate the wear and tear of the chain and guide bar, possibly resulting further in a chain cut and even in a fatal accident leading to death.

- For chain oil, use a type that is sufficiently viscous and adequately lubricating under the summer-use conditions and another type that shows similar performance under the winter-use conditions.
- The use of Zenoah genuine chain oil is recommended to make your chain saws last as long as possible. If no genuine chain oil is available, please use commercially available chain oil, which is commonly used.

### CAUTION

Using waste oil, recycled oil, or anything similar causes a breakdown and also proves harmful to the human body and environment. Please do not under any circumstances use any such material.

#### 📌 IMPORTANT

Use chain oil of vegetable origin. Before storing it for a long period, remove the chain oil from the blade and chain groove and clean them. If not, the chain may become rusted. Chain rust will cause the chain to become rigid or to become viscous at the tip.

# 5. Operating the Engine

## ⚠ WARNING

It is very dangerous to run a chainsaw that mounts broken parts or lacks any parts. Before starting engine, make sure that all the parts including bar and chain are installed properly.

## ■ STARTING THE ENGINE

1. Fill fuel and chain oil tanks respectively, and tighten the caps securely.

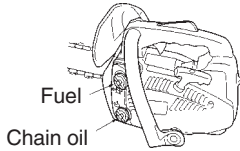

2. Continuously push the priming bulb until fuel comes in the bulb.

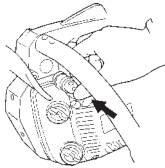

3. Set the switch to "I" position.

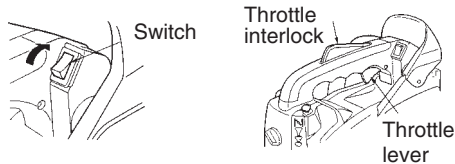

4. Pull out the choke knob to the second-stage position. The choke will close and the throttle lever will then be set in the starting position.

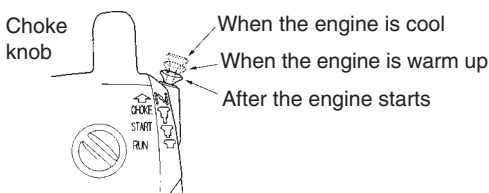

## 📖 NOTE

When restarting immediately after stopping the engine, set the Choke knob in the first-stage position (choke open and throttle lever in the starting position).

Once the choke knob has been pulled out, it will not return to the operating position even if you press down on it with your finger. When you wish to return the choke knob to the operating position, pull out the throttle lever instead.

5. While holding the saw unit securely on the ground, pull the starter rope vigorously.

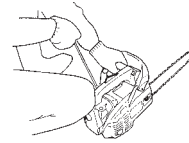

## ⚠ WARNING

Do not start the engine while the chain saw hangs in one hand. The saw chain may touch your body. This is very dangerous.

6. When engine has ignited, first push in the choke knob to the first-stage position and then pull the starter again to start the engine.
7. Allow the engine to warm up with the throttle lever pulled slightly.

## ■ CHECKING THE OIL SUPPLY

### ⚠ WARNING

Make sure to set up the bar and the chain when checking the oil supply. If not, the rotating parts may be exposed. It is very dangerous.

After starting the engine, run the chain at medium speed and see if chain oil is scattered off as shown in the figure.



The chain oil flow can be changed by inserting a screwdriver in the hole on bottom of the clutch side. Adjust according to your work conditions.

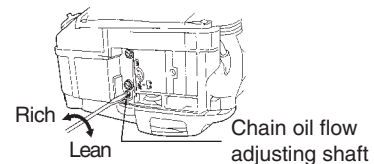

The oil tank should become nearly empty by the time fuel is used up. Be sure to refill the oil tank every time when refueling the saw.

## ■ ADJUSTING THE CARBURETOR

Idle adjusting screw

H needle

L needle

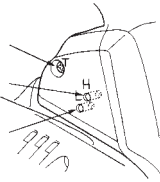

The carburetor on your unit has been factory adjusted, but may require fine tuning due to a change in operating conditions.

Before adjusting the carburetor, make sure that the provided air/fuel filters are clean and fresh and the fuel properly mixed.

When adjusting, take the following steps:

### NOTE

Be sure to adjust the carburetor with the bar chain attached.

1. H and L needles are restricted within the number of turn as shown below.

H needle : -1/4

L needle : -1/4

2. Start the engine and allow it to warm up in low speed for a few minutes.
3. Turn the idle adjusting screw (T) counterclockwise so that the saw chain does not turn. If the idling speed is too slow, turn the screw clockwise.
4. Make a test cut and adjust the H needle for best cutting power, not for maximum speed.

## ■ CHAIN BRAKE

The chain brake is a device which stops the chain instantaneously if the chain saw recoils due to kickback. Normally, the brake is activated automatically by inertial force. It can also be activated manually by pushing the brake lever (left-hand guard) down toward the front. When the brake operates, a yellow cone pops up from the base of the brake lever.

### Releasing the Brake

Pull the brake lever up toward the left-hand handle until it clicks into place.

### WARNING

- When the brake operates, release the throttle lever to slow down the engine speed. Continuous operation with the brake engaged will generate heat from the clutch and may cause trouble.
  - At machine inspection prior to each job, check the operating condition of the brake following the steps.
1. Start the engine and grasp the handle securely with both hands.
  2. Pulling the throttle lever to maintain the chain operation, push the brake lever (left-hand guard) down toward the front using the back of your left hand.
  3. When the brake operates and the chain is stopped, release the throttle lever.
  4. Release the brake.

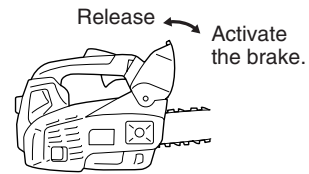

## ■ STOPPING THE ENGINE

1. Release the throttle lever to allow the engine to idle for a few minutes.
2. Set the switch to the "O" (STOP) position.

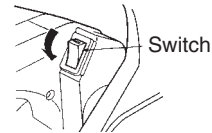

## 6. Sawing

### ⚠ WARNING

- Before proceeding to your job, read the section "For Safe Operation". It is recommended to first practice sawing easy logs. This also helps you get accustomed to your unit.
- Always follow the safety regulations. The chain saw must only be used for cutting wood. It is forbidden to cut other types of material. Vibrations and kickback vary with different materials and the requirements of the safety regulations would not be respected. Do not use the chain saw as a lever for lifting, moving or splitting objects. Do not lock it over fixed stands. It is forbidden to hitch tools or applications to the PTO other than those specified by the manufacturer.



- It is not necessary to force the saw into the cut. Apply only light pressure while running the engine at full throttle.
- When the saw chain is caught in the cut, do not attempt to pull it out by force, but use a wedge or a lever to open the way.
- If the guide bar and saw chain becomes caught in wood while operating it, stop the engine. Do not pry the handle with excessive force. Use a wedge to remove the chain instead.

### ■ GUARD AGAINST KICKBACK

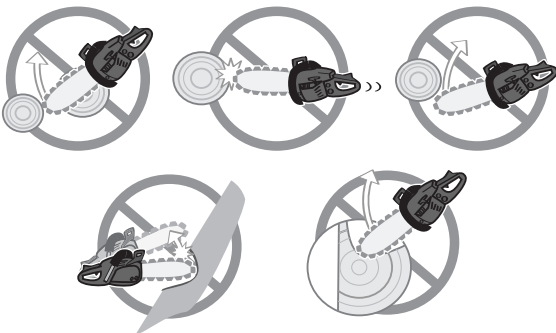

- This saw is equipped with a chain brake that will stop the chain in the event of kickback if operating properly. You must check the chain brake operation before each usage by running the saw at full the throttle for 1 - 2 seconds and pushing the front hand guard forward. The chain

should stop immediately with the engine at full speed. If the chain is slow to stop or does not stop, replace the brake band and clutch drum before use.

- It is extremely important that the chain brake be checked for proper operation before each use and that the chain be sharp in order to maintain the kickback safety level of this saw. Removal of the safety devices, inadequate maintenance, or incorrect replacement of the bar or chain may increase the risk of serious personal injury due to kickback.



### ■ FELLING A TREE

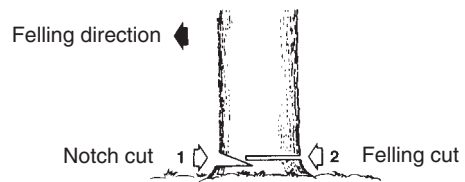

1. Decide the felling direction considering the wind, lean of the tree, location of heavy branches, ease of completing the task after felling and other factors.
2. While clearing the area around the tree, arrange a good foothold and retreat path.
3. Make a notch cut one-third of the way into the tree on the felling side.
4. Make a felling cut from the opposite side of the notch and at a level slightly higher than the bottom of the notch.

### ⚠ WARNING

When you fell a tree, be sure to warn neighboring workers of the danger.

### Bucking and Limbing

### ⚠ WARNING

- Always ensure your foothold. Do not stand on the log.
- Be alert to the rolling over of a cut log. Especially when working on a slope, stand on the uphill side of the log.
- Follow the instructions in "For Safe Operation" to avoid kickback of the saw.

Before starting work, check the direction of bending force inside the log to be cut. Always finish cutting from the opposite side of the bending direction to prevent the guide bar from being caught in the cut.

### A log lying on the ground

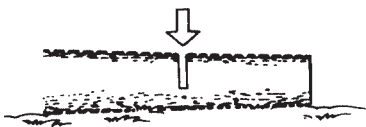

Saw down halfway, then roll the log over and cut from the opposite side.

### A log hanging off the ground

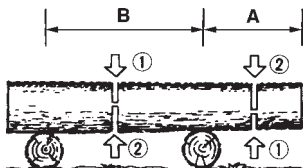

In area A, saw up from the bottom one-third and finish by sawing down from the top. In area B, saw down from the top one-third and finish by sawing up from the bottom.

### Cutting the limbs of Fallen Tree

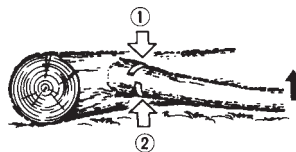

First check to which side the limb is bent. Then make the initial cut from the bent side and finish by sawing from the opposite side.

#### **⚠ WARNING**

Be alert to the springing back of a cut limb.

### Pruning of Standing Tree

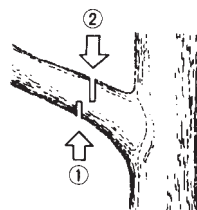

Cut up from the bottom, finish down from the top.

#### **⚠ WARNING**

- Do not use an unstable foothold or ladder.
- Do not overreach.
- Do not cut above shoulder height.
- Always use both your hands to hold the saw.

# 7. Maintenance

## ▲ WARNING

Before cleaning, the inspecting or repairing the unit, make sure that engine has stopped and is cool. Disconnect the spark plug to prevent accidental starting.

## ■ MAINTENANCE AFTER EACH USE

### 1. Air filter

Loosen the knob and remove the air cleaner cover. Take off the filter elements and tap off attached sawdust. When they are extremely dirty, shakewash with gasoline. Dry them completely before reinstalling.



### 2. Oiling port

Dismount the guide bar and check the oiling port for clogging.

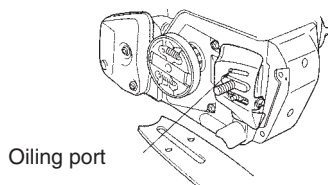

### 3. Guide bar

When the guide bar is dismantled, remove sawdust in the bar groove and the oiling port.

#### <Type : sprocket nose>

Grease the nose sprocket from the feeding port on the tip of the bar.

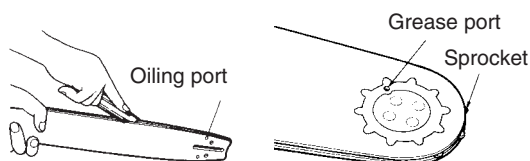

### 4. Others

Check for fuel leakage and loose fastenings and damage to major parts, especially handle joints and guide bar mounting. If any defects are found, make sure to have them repaired before operating the saw again.

## ■ PERIODICAL SERVICE POINTS

### 1. Cylinder fins

Periodically check and clean the cylinder fins in the repair specialty store.

### 2. Fuel filter

(a) Using a wire hook, take out the filter from the filler port.

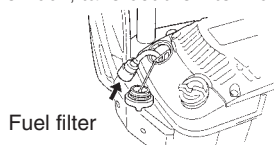

(b) Wash the filter with gasoline.

Replace with new one if clogged with dirt completely.

## ▲ WARNING

When returning the filter, use a pinch not to be folded the suction pipe.

### 3. Oil filter

1. With a wire hook, take out the oil filter from the feeding port.

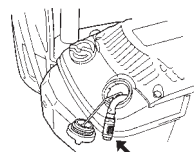

Oil filter

2. Wash the filter with gasoline.

## ▲ WARNING

When returning the filter, use a pinch not to be folded the suction pipe.

### 4. Spark plug

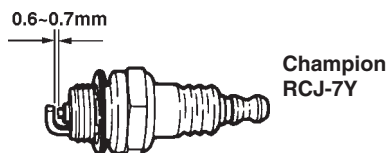

Champion  
RCJ-7Y

Clean the electrodes with a wire brush and reset the gap to 0.6 mm as necessary.

### 5. Sprocket

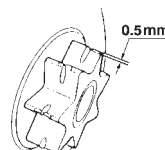

Check for cracks and for excessive wear interfering with the chain drive. If the wear is considerable, replace it with new one. Never fit a new chain on a worn sprocket, or a worn chain on a new sprocket.

### 6. Way of the cooling air

## ▲ WARNING

- The engine metal parts can burn your skin. Never touch the cylinder, muffler or ignition plug etc. during operation or right after stopping the engine.
- Before starting the engine, check around the muffler and take off sawdust. If you do not, it will cause the overheating and a fire. For preventing the trouble, please keep clean around the muffler.

This engine is air-cooled. Dust clogging between the inlet port of the cooling air and cylinder fins will cause overheating of the engine. Periodically check and clean the cylinder fins in the repair specialty store.

## 7. Muffler

### ▲ WARNING

If you do not attach the muffler correctly, after engine starts, the muffler will be loosen and the hightemperature exhaust gas spout. After cleaning the muffler, pay attention to fit up the muffler according to the explanation as follows.

1. Muffler body, muffler cover and baffle will be combined correctly.

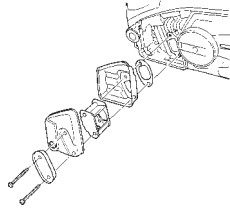

2. Be sure the gasket is not broken. If it is broken, change to the new one.
3. Before tightening the screw, rub the gross on it.
4. After making a test run, re-tighten the screw (TORQUE: 6.9-7.8 N.m./70-80 kg-cm)

### ▲ WARNING

Right after stopping the engine, do not touch the muffler with one's bare hands. It will cause to burn your hands.

If carbon clogs between the muffler, it will cause the poor-out-put and the trouble in starting. After each 100 hours, check and clean inside the muffler.

# 8. Maintenance of Saw Chain and Guide Bar

## ■ Saw Chain

### ▲ WARNING

It is very important for smooth and safe operation to always keep the cutters sharp.

The cutters need to be sharpened when:

- Sawdust becomes powder-like.
- You need extra force to saw in.
- The cut path does not go straight.
- Vibration increases.
- Fuel consumption increases.

Cutter setting standards:

### ▲ WARNING

Be sure to wear safety gloves.

Before filing:

- Make sure the saw chain is held securely.
- Make sure the engine is stopped.
- Use a round file of proper size for the chain.

Chain type: 91VG / 25AP

File size: 5/32 in (4.0 mm)

Place the file on the cutter and push straight forward. Keep the file position as illustrated.

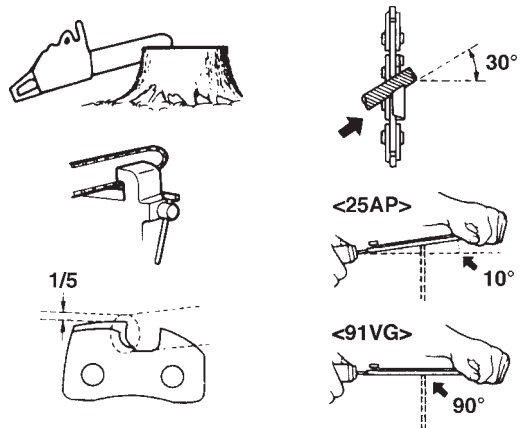

After each cutter has been filed, check the depth gauge and file it to the proper level as illustrated.

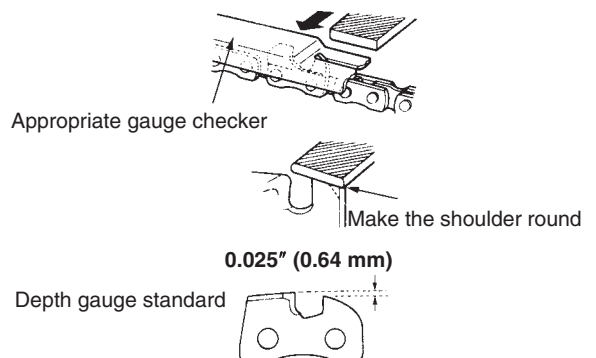



**▲ WARNING**

Be sure to round off the front edge to reduce the chance of kickback or tie-strap breakage.

Make sure every cutter has the same length and edge angles as illustrated.

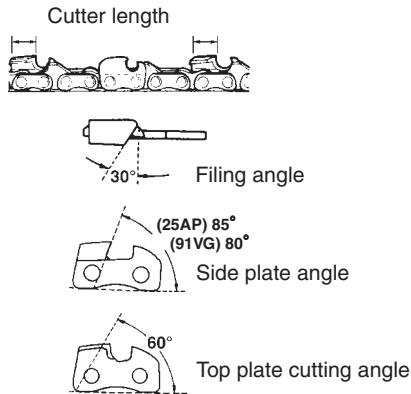
**■ Guide Bar**

- Reverse the bar occasionally to prevent partial wear.
- The bar rail should always be square. Check for wear of the bar rail. Apply a ruler to the bar and the out

side of a cutter. If a gap is observed between them, the rail is normal. Otherwise, the bar rail is worn. Such a bar needs to be corrected or replaced.

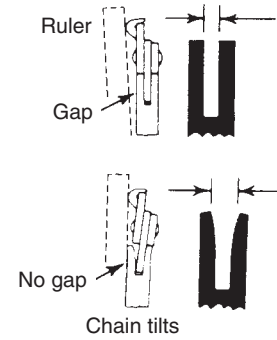
**WARNING:**

This saw is equipped with one of the following low kickback bar/chain combinations:

Bar Size	Guide Bar	Zenoah Part Number Saw Chain
10	2475-52111	2475-52210 (91VG)
10	2475-52121	3622-52210 (25AP)

## 9. Troubleshooting Guide

**Case 1. Starting failure****▲ WARNING**

Make sure the icing prevention system is not working.

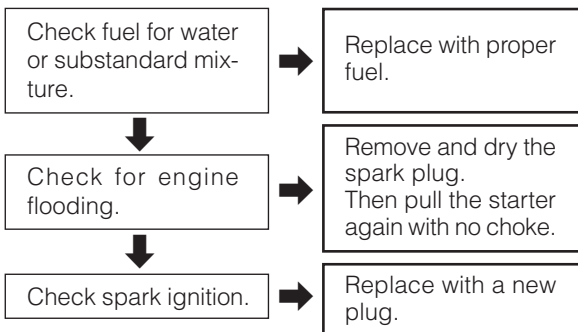
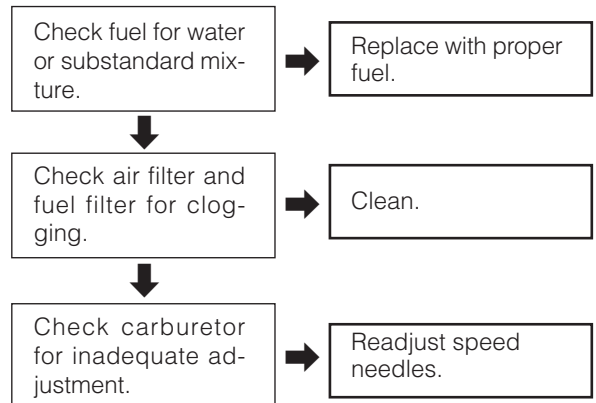
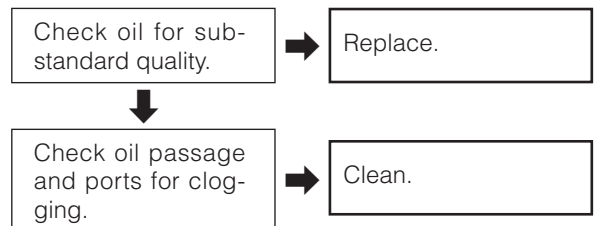
**Case 2. Lack of power/Poor acceleration/  
Rough idling****Case 3. Oil does not come out**

## 10. Disposal

- When you dispose of the machine, do not disassemble the machine.
- When you dispose of the machine, fuel, chain oil, be sure to follow your local regulations.

If the unit seems to need further service, please consult with an authorized service shop in your area.

# 11. Specifications

## Power unit:

Displacement (cm<sup>3</sup>): ..... 25.4  
 Fuel: ..... Mixture (Gasoline 50 : Two-cycle oil 1)  
 (when using ZENOAH genuine oil)  
 Fuel tank capacity (cm<sup>3</sup>): ..... 230  
 Chain oil: ..... Motor oil SAE# 10W-30  
 Oil tank capacity (cm<sup>3</sup>): ..... 160  
 Carburetor: ..... Diaphragm type  
 Ignition system: ..... Solid State  
 Spark plug: ..... Champion RCJ-7Y  
 Oil feeding system: ..... Mechanical pump  
 Max. speed ..... 12,500 (min<sup>-1</sup>)  
 Idle speed ..... 2,900 (min<sup>-1</sup>)

Dimensions (L x W x H) (mm): ..... 265 x 220 x 220  
 Dry weight  
 Power unit only (kg): ..... 2.9  
 Power: ..... 0.93/9,000 (kw/min<sup>-1</sup>)

## Cutting head:

### <Sprocket bar>

Sprocket: ..... 6T  
 Chain speed at max. power ..... 17.1 (m/s)  
 Guide bar

Type: ..... Sprocket nose  
 Size (in. (cm)): ..... 10 (25)

### Saw chain

Type: ..... Oregon 91VG  
 Pitch (in. (mm)): ..... 3/8 (9.53)  
 Gauge (in. (mm)): ..... 0.05 (1.27)

### <Hard nose bar>

Sprocket: ..... 8T  
 Chain speed at max. power ..... 15.2 (m/s)  
 Guide bar

Type: ..... ZENOAH carving (Hard nose)  
 Size (in. (cm)): ..... 10 (25)

### Saw chain

Type: ..... Oregon 25AP  
 Pitch (in. (mm)): ..... 1/4 (6.35)  
 Gauge (in. (mm)): ..... 0.05 (1.27)

Specifications are subject to change without notice.

# 12. Limited warranty

Should any failure occur on the product under normal operating conditions within the applicable warranty period, the failed part will be replaced or repaired free of charge by a ZENOAH authorized dealer.

**WARRANTY PERIOD:** 1 year (6 months if used professionally, and 30 days if used for rental purpose) from the date of initial purchase.

THE PURCHASER SHALL BEAR COSTS OF TRANSPORTING THE UNIT TO AND FROM THE ZENOAH DEALER.

THE PURCHASER SHALL NOT BE CHARGED FOR DIAGNOSTIC LABOR WHICH LEADS TO THE DETERMINATION THAT A WARRANTED PART IS DEFECTIVE, IF THE DIAGNOSTIC WORK IS PERFORMED AT THE ZENOAH DEALER.

THE PURCHASER OR OWNER IS RESPONSIBLE FOR THE PERFORMANCE OF THE REQUIRED MAINTENANCE AS DEFINED BY THE MANUFACTURER IN THE OWNER/OPERATOR MANUAL.

ANY WARRANTED PART WHICH IS NOT SCHEDULED FOR REPLACEMENT AS REQUIRED MAINTENANCE, OR WHICH IS SCHEDULED ONLY FOR REGULAR INSPECTION TO THE EFFECT OF REPAIR OR "REPLACE AS NECESSARY" SHALL BE WARRANTED FOR THE WARRANTY PERIOD. ANY WARRANTED PART WHICH IS SCHEDULED FOR REPLACEMENT AS REQUIRED MAINTENANCE SHALL BE WARRANTED FOR THE PERIOD OF TIME UP TO THE FIRST SCHEDULED REPLACEMENT POINT FOR THE PART.

ANY REPLACEMENT PART THAT IS EQUIVALENT IN PERFORMANCE AND DURABILITY MAY BE USED IN NON-WARRANTY MAINTENANCE OR REPAIRS, AND

SHALL NOT REDUCE THE WARRANTY OBLIGATION OF THE COMPANY.

THE COMPANY IS LIABLE FOR DAMAGES TO OTHER ENGINE COMPONENTS CAUSED BY THE FAILURE OF A WARRANTED PART STILL UNDER WARRANTY.

**THE WARRANTY DOES NOT APPLY TO THOSE UNITS WHICH HAVE BEEN DAMAGED BY NEGLIGENCE OF INSTRUCTION LISTED IN THE OWNER/OPERATOR MANUAL FOR PROPER USE AND MAINTENANCE OF THE UNITS ACCIDENT MISHANDLING, ALTERATION, ABUSE, IMPROPER LUBRICATION, USE OF ANY PARTS OR ACCESSORIES OTHER THAN THOSE SPECIFIED BY THE COMPANY, OR OTHER CAUSES BEYOND THE COMPANY'S CONTROL.**

**THIS WARRANTY DOES NOT COVER THOSE PARTS REPLACED BY NORMAL WEAR OR HARMLESS CHANGES IN THEIR APPEARANCE.**

**THERE ARE NO OTHER EXPRESS WARRANTIES.**

**IMPLIED WARRANTIES** INCLUDING THOSE OF MERCHANTABILITY AND FITNESS FOR A PARTICULAR PURPOSE **ARE LIMITED** TO TWO (2) YEARS OF HOME USE [ONE (1) YEAR FOR ANY OTHER USE] FROM THE ORIGINAL DELIVERY DATE.

**LIABILITIES FOR INCIDENTAL OR CONSEQUENTIAL DAMAGE UNDER ANY AND ALL WARRANTIES ARE EXCLUDED.**

IF YOU NEED TO OBTAIN MORE INFORMATION, PLEASE CALL YOUR NEAREST SERVICE CENTER, OR CHECK PLEASE ZENOAH WEB SITE <http://www.zenoah.net>