

FFP 5000 UVC Art. 7883

D Betriebsanleitung

UVC-Unterwasserfilter mit Wasserspielpumpen-Set

GB Operating Instructions

UVC Underwater Filter with Fountain Pump Set

F Mode d'emploi

Filtre immergé UVC avec kit pompe pour jets d'eau

NL Instructies voor gebruik

UVC-onderwaterfilter met vijverpompset

S Bruksanvisning

UVC-Undervattensfilter med pumpset för fontäner

I Istruzioni per l'uso

Filtro subacqueo UVC con set per giochi d'acqua

E Manual de instrucciones

Filtro sumergible UVC con bomba para fuentes de agua

P Instruções de manejo

Filtro submersível UVC com conjunto de bombas de jogos de água

DK Brugsanvisning

UVC-Undervandsfilter med springvandspumpesæt

GARDENA UVC Underwater Filter with Fountain Pump Set FFP 5000 UVC



Translation of the original instructions from German. Please read these operating instructions carefully and observe the notes given. Use these operating instructions to familiarise yourself with the UVC Underwater Filter with Fountain Pump Set, its proper use and the safety instructions.



For safety reasons, children under 16 as well as persons not familiar with these operating instructions must not use this UVC Underwater Filter with Fountain Pump Set.

→ Keep these operating instructions in a safe place.

Contents

1. Where to use Your GARDENA UVC Underwater Filter with Fountain Pump Set	11
2. Safety Instructions	11
3. Assembly	13
4. Initial Operation	14
5. Putting into Storage	14
6. Maintenance	15
7. Troubleshooting	16
8. Accessories	17
9. Technical Data	17
10. Service / Warranty	18

1. Where to use your GARDENA UVC Underwater Filter with Fountain Pump Set

Intended use

The GARDENA UVC Underwater Filter is for private use for cleaning outdoor garden ponds up to 5000 l with and without fish stocks. It is not designed for operating watering equipment or irrigation systems. The pond can be aerated with the UVC Underwater Filter together with the Pond Aerator **Art. 7942 / 7943**.

Please note



The GARDENA UVC Underwater Filter is not suitable for continuous operation in industrial applications. Corrosive, easily combustible, aggressive or explosive substances (e.g. petrol, petroleum, nitro thinner) as well as saltwater or food and drinking water must not be pumped.

2. Safety Instructions

→ Comply with the safety instructions on the UVC Underwater Filter.



WARNING !

→ Read the operating instructions before using the equipment for the first time!



DANGER !

Protect eyes from flash. This radiation is harmful to eyes and skin.

→ **Never operate the UVC Underwater Filter when the housing has been removed.**

Electrical Safety:

The UVC Underwater Filter must be operated via a residual-current device (FI-switch) with a nominal fault current ≤ 30 mA (DIN VDE 0100-702 and 0100-738).

The UVC Underwater Filter must be placed on solid, even ground.

→ Please ask your electrician for his advice.

Always disconnect the UVC Underwater Filter from the mains before undertaking any work on it.

Power cables must not be of lower quality than the H05 RNF rubber hose lines.

Extension cables must meet the requirements of DIN VDE 0620.

The information on the model plate of the UVC Underwater Filter must match the power supply.

The connection cable of the Pump and the UVC Underwater Filter cannot be replaced. If there is any damage to the mains connection lead the corresponding unit must be disposed of.

Do not use extension leads, connection leads or adapters without a protective contact.

Never carry the UVC Underwater Filter by the cable. Do not pull on the cable to unplug the plug from the socket.

Please protect the cable from heat, oil and sharp edges. Make sure that connection points remain dry.

Please unplug the pump and the UVC Underwater Filter after operation and before carrying out any maintenance works.

The UVC Underwater Filter must not be operated when there are people in the water.

Swimming pools and garden ponds should be designed according to international and national design regulations.

→ Please consult a professional electrician.

For Austria

Units for use in swimming pools and in ponds must only be operated via an isolating transformer.

→ Please consult a professional electrician.

For Switzerland

In Switzerland mobile appliances which are used outdoors, must be connected via a residual-current device.

Note:

→ Inspect the equipment before use to ensure that the Pump and the UVC Underwater Filter, especially the power cable and plug, are undamaged.

Do not use a damaged UVC Underwater Filter.

Do not use the light if the connection lead, glass tube or the housing of the UVC unit appear to be defective.

If the Pump or UVC Underwater Filter are damaged, please have them checked by our GARDENA Service Centre or an authorised electrician.

The temperature of the liquid used must not be below 4 °C or above 35 °C.

Sand and other abrasive substances in the liquid cause increased wear and reduce the output of the pump.

Do not allow the pump to run without water because dry-running leads to an undesirable build up of heat.

UVC unit safety switch:

If the UVC light overheats, it is switched off by the built-in thermal protection switch. The UVC light switches itself on again automatically when it has cooled down sufficiently.

Due to a built-in safety switch, the lamp only lights up when the UVC unit has been fully installed.

→ Never operate the UVC unit without water throughput.

3. Assembly

Assembling the UVC bulb:

→ To assemble the UVC lamp see **7. Troubleshooting** “**Replacing the UVC bulb**”.

A Installing the set as a fountain pump:

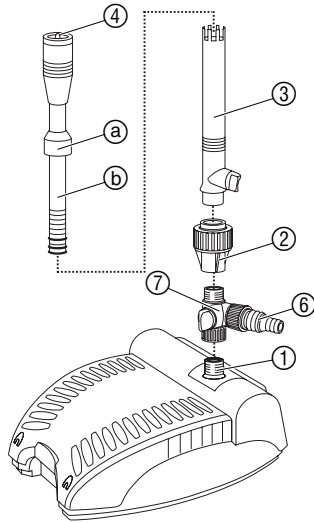

The stepped nipple (1/2" / 3/4") ⑥ can be used for connection, for example, to a gargoyle.
If the side outlet is not needed the ⑥ sealing cap ⑧ can be screwed in instead of the step nipple.

1. Screw the T-joint ⑦ onto the connection ①.
2. Screw the stepped nipple ⑥ onto the side outlet of the T-piece ⑦.
3. Screw the ball joint ② onto the T-piece ⑦.
4. Push the nozzle tube ③ onto the telescopic handle ⑥ up to the sleeve ⑤.
5. Snap the nozzle tube ③ into the ball joint ②.
6. Screw required fountain insert ④ a) / b) / c) / d) fully into the nozzle tube ③.



a) Cascade



b) Water Bell



c) Fleur-de-Lis



d) Water Jets

B Installing the set as a stream pump:

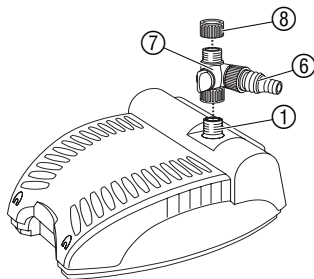

The stepped nipple (1/2" / 3/4") ⑥ can be used for connection, for example, to a stream or source stone.

1. Screw the T-joint ⑦ onto the connection ①.
2. Screw the stepped nipple ⑥ onto the side outlet of the T-piece ⑦.
3. Screw the cap ⑧ onto the T-piece ⑦.

Connecting the pond aerator (available as an option):

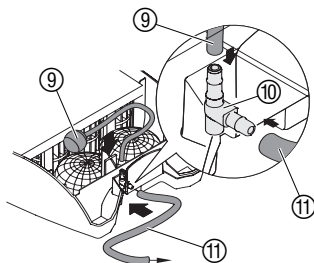

The GARDENA Pond Aerator **Art. 7942 / 7943** can be connected to increase the oxygen content. The aragonite and the hose are supplied with the pond aerator.

1. Remove the filter housing (see 6. Maintenance).
2. Connect the aragonite ⑨ with a piece of hose to the air connection piece ⑩.
3. Put the aragonite ⑨ between the filter stone bags ensuring that the hose is not kinked.
4. Connect the pond aerator hose ⑪ to the air connection piece ⑩ from the outside.

4. Initial Operation

A Putting into operation as a fountain pump:

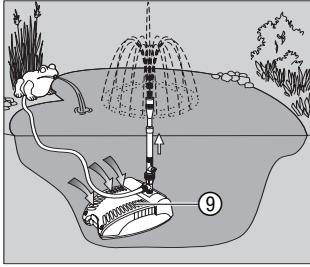

Note: In the event of an uneven foundation, the fountain can be vertically aligned with the adjustable ball joint (2).

1. When using a gargoyle, connect the hose of the gargoyle to the stepped nipple (6).
2. Place the UVC Underwater Filter with the fountain on a firm base so that the filter housing (9) is completely covered by water.
3. Undo the fixing nut (14) of the ball joint (2), place nozzle tube (3) vertically and screw fixing nut (14) tight again.
4. Connect the mains plug of the UVC Underwater Filter to an A.C. socket.

Attention: pump starts immediately.

5. Unscrew **Water Bell, Fleur-de-Lis or Water Jets** out of the nozzle tube (3) until the fountain has the required shape.
6. Adjust the size of the fountain with the regulating valves (5).
7. Adjust the required amount of water of the gargoyle with the regulating valves (10).

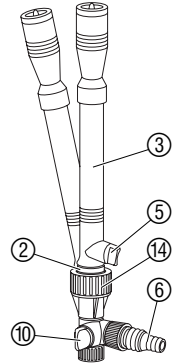

B Putting into operation as a stream pump:

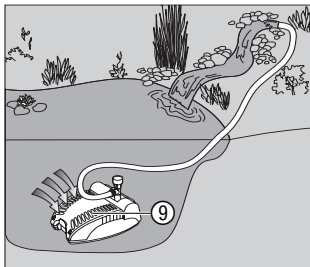

Note: When using a 3/4" hose, the front part of the stepped nipple can be cut off with a saw.

1. Connect the hose of the stream to the stepped nipple (6).
2. Place the UVC Underwater Filter with the stepped nipple on a firm base so that the filter housing (9) is completely covered by water (max. 2 m under water).
3. Connect the mains plug of the UVC Underwater Filter to an A.C. socket. **Attention: filter pump starts immediately.**
4. Adjust the required amount of water with the regulating valves (10).

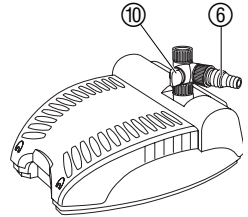

5. Putting into Storage

Overwintering / Storage:



The storage location must not be accessible to children.

1. Remove the UVC Underwater Filter from the pond before frost is expected, clean and store in a frost-free place.
2. To avoid difficulties when starting up in the spring, we recommend storing the pump in a frost-free location in a container filled with water.

The mains plug must not be submerged.

Disposal:
(in accordance with
RL2002/96/EC)



The product must not be added to normal household waste. It must be disposed of in line with local environmental regulations.
→ Important: Make sure that the unit is disposed of via your municipal recycling collection centre.

6. Maintenance

Cleaning the UVC Underwater Filter:

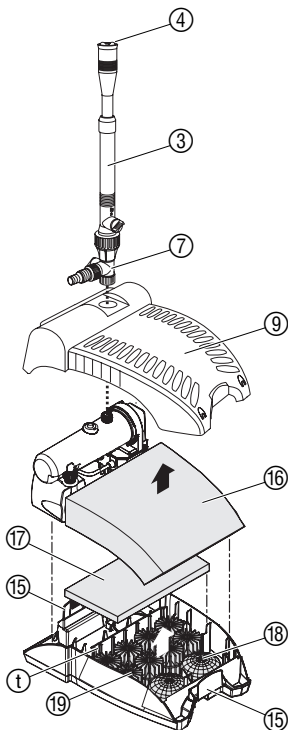

DANGER! Electric shock!

→ **Unplug the UVC Underwater Filter before any maintenance work.**

Do not use any hard objects or abrasive cleaning materials to clean it.

1. Unscrew the T-piece ⑦ with the nozzle pipe ③.
2. Unscrew the fountain insert ④ from the nozzle pipe ③.
3. Clean the fountain insert ④ and nozzle pipe ③ with clean water.
4. Unlock the two lugs ⑮ and remove the filter housing ⑨.
5. Remove the filter foam ⑯ / ⑰.
6. Clean the filter housing ⑨ and the filter foam ⑯ / ⑰ under running water.
7. Remove the biological surface elements ⑲ and filter stone bags ⑱ and rinse lightly in clean water (do not clean under running water).
8. Remove the dividing wall ①.
9. Assemble the UVC Underwater Filter again in reverse order. When you do this ensure that the connection cable ⑳ runs correctly through the cable guide and that the connection cable ㉑ is not trapped.

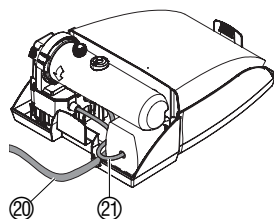

Cleaning the UVC unit:

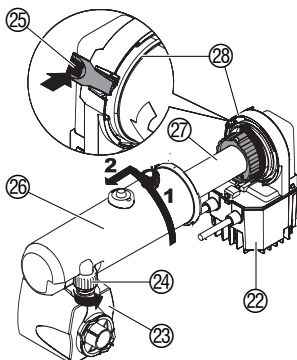

1. Remove the UV unit ㉒ and the pump ㉓ from the UV underwater filter (see "Cleaning the UVC Underwater Filter").
2. Unscrew the pump ㉓ by turning the collar ㉔ anti-clockwise (do not turn the pump).
3. Unlock the lugs ㉕ and turn the cover ㉖ anti-clockwise **1** and remove carefully **2** (bayonet fitting).
4. Clean the glass plunger ㉗ (e.g. with a liquid glass cleaner).
5. Put the UV unit back again in reverse order.

When fitting ensure that the O-ring ㉘ is inserted correctly into the UV unit ㉒.

7. Troubleshooting

Cleaning the pump:

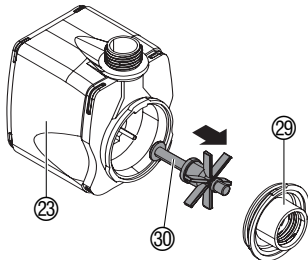

DANGER ! Electric shock!

→ Before troubleshooting unplug the UVC Underwater Filter.

1. Remove the pump from the UVC Underwater Filter (see "Cleaning the UV unit").
2. Turn pump cover 29 anti-clockwise and draw vertically out of the motor housing 23 (bayonet fitting).
3. Draw rotor unit 30 out of motor housing 23 and clean.
4. Push cleaned rotor unit 30 back into the motor housing 23.
5. Press pump cover 29 vertically on to the motor housing 23 and close by turning clockwise (bayonet fitting).
6. Put the pump back again in reverse order.

Replacing the UVC bulb:

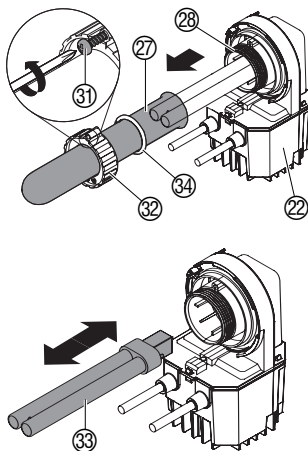

The UVC bulb should be replaced after approximately 8,000 operating hours since the UVC performance decreases dramatically after this time.

Only 11W TC-S (UV-C) bulbs must be used, e.g. GARDENA UVC replacement bulbs **Art. 5390**.

1. Remove the UV unit 22 from the UV underwater filter (see "Cleaning the UV unit").
2. Unscrew the screw 31 and unscrew the collar 28 carefully.
3. Pull off the glass tube 27 (It may be relatively difficult to remove the glass tube due to mineral deposits.)
4. Take out faulty bulb 33 and insert new bulb.
5. Reassemble the UVC unit in reverse order.

When assembling, ensure that the O-ring 29 is inserted correctly into the UV unit 22 and the O-ring 34 is inserted correctly into the collar 28.

Due to the integrated safety switch the lamp only comes on when the UVC unit is properly installed.

Fault	Possible cause	Remedy
No water feature operating	Mains plug not plugged in.	→ Plug in mains plug.
	Impeller unit is blocked.	→ Clean pump.
Reduced water feature	Water feature insert is dirty.	→ Clean water feature insert and nozzle pipe.
	Filter dirty.	→ Clean filter.
The UVC pilot light is not on	Bulb defective.	→ Change bulb.
	Electrical connections defective.	→ Check electrical connections.

Fault	Possible cause	Remedy
The UVC pilot light is not on	Cover ②6 not engaged properly.	→ Fit cover ②6 properly (see “Cleaning the UV unit”).
The water is not clear	Filter or delivery capacity of the pump not suitable.	→ Check whether the UVC Underwater Filter is sufficient for the pond. See 1. Ranges of uses for your GARDENA UVC Underwater Filter
	Too many fish and creatures in the pond.	→ Add up the estimated length of the fish. There should only be “80 cm fish” per m ³ water in the pond.
	The glass tube of the UVC unit is dirty.	→ Clean UVC unit (see 6. Maintenance).



In the event of other faults please contact GARDENA Service. Repairs should only be carried out by GARDENA service centres or dealers authorised by GARDENA.

8. Accessories

GARDENA Underwater Lights	Illuminate the fountains and bank area from underneath and above the water surface.	Art. 7952 / 7954 / 7958
GARDENA LED Underwater Light Set	Illuminate the fountains and bank area from underneath and above the water surface.	Art. 4351
GARDENA Pond Aerator	To aerate the pond water.	Art. 7942 / 7943
GARDENA Replacement Bulb	Replacement bulb for the UVC unit.	Art. 5390
GARDENA Remote Control Set	To turn electrical equipment on and off from inside or outside.	Art. 7680

9. Technical Data

FFP 5000 UVC (Art. 7883)	
Mains voltage / Frequency	230 V / 50 Hz
Power cable	10 m H05 RN-3G x 0.75
Max. submersion depth	2 m
Media temperature	4 °C – 35 °C
Bulb:	
Rated power	11 W
Type	11 W TC-S (UV-C)

Pump:

Rated power	35 W
Max. flow / pumping height	1,100l/h / 2.2 m

10. Service / Warranty

GARDENA guarantees this product for 2 years (from date of purchase). This guarantee covers all serious defects of the unit that can be proved to be material or manufacturing faults. Under warranty we will either replace the unit or repair it free of charge if the following conditions apply:

- The unit must have been handled properly and in keeping with the requirements of the operating instructions.
- Neither the purchaser or a non-authorised third party have attempted to repair the unit.

The wearing parts UVC bulb, filter foam and rotor unit are excluded from the warranty.

This manufacturer's guarantee does not affect the user's existing warranty claims against the dealer/seller.

If you have any problems with your UVC Underwater Filter with Fountain Pump Set, please contact our Service or return the defective unit together with a short description of the problem – in case of guarantee, with a copy of the receipt – postage paid to one of the GARDENA Service Centres listed on the back of this leaflet.

FFP 5000 UVC Art. 7883

Pumpen-Kennlinie
Performance characteristics
Courbes de performance
Prestatiegrafiek
Kapacitetskurva
Curva di rendimento
Curva característica
de la bomba
Características
de performance
Ydelses karakteristika

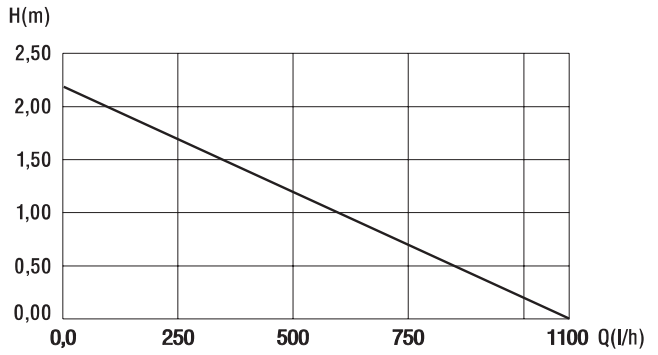

<p>D <i>Produkthftung</i></p>	<p>Wir weisen ausdrücklich darauf hin, dass wir nach dem Produkthaftungsgesetz nicht für durch unsere Geräte hervorgerufene Schäden einzustehen haben, sofern diese durch unsachgemäße Reparatur verursacht oder bei einem Teileaustausch nicht unsere Original GARDENA Teile oder von uns freigegebene Teile verwendet werden und die Reparatur nicht vom GARDENA Service oder dem autorisierten Fachmann durchgeführt wird. Entsprechendes gilt für Ergänzungssteile und Zubehör.</p>
<p>GB <i>Product Liability</i></p>	<p>We expressly point out that, in accordance with the product liability law, we are not liable for any damage caused by our units if it is due to improper repair or if parts exchanged are not original GARDENA parts or parts approved by us, and, if the repairs were not carried out by a GARDENA Service Centre or an authorised specialist. The same applies to spare parts and accessories.</p>
<p>F <i>Responsabilité</i></p>	<p>Nous vous signalons expressément que GARDENA n'est pas responsable des dommages causés par ses appareils, dans la mesure où ces dommages seraient causés suite à une réparation non conforme, dans la mesure où, lors d'un échange de pièces, les pièces d'origine GARDENA n'auraient pas été utilisées, ou si la réparation n'a pas été effectuée par le Service Après-Vente GARDENA ou l'un des Centres SAV agréés GARDENA. Ceci est également valable pour tout ajout de pièces et d'accessoires autres que ceux préconisés par GARDENA.</p>
<p>NL <i>Productaansprakelijkheid</i></p>	<p>Wij wijzen er nadrukkelijk op, dat wij op grond van de wet aansprakelijkheid voor producten niet aansprakelijk zijn voor schade ontstaan door onze apparaten, indien deze door onvakkundige reparatie veroorzaakt zijn, of er bij het uitwisselen van onderdelen geen gebruik gemaakt werd van onze originele GARDENA onderdelen of door ons vrijgegeven onderdelen en de reparatie niet door de GARDENA technische dienst of de bevoegde vakman uitgevoerd werd. Ditzelfde geldt voor extra-onderdelen en accessoires.</p>
<p>S <i>Produktansvar</i></p>	<p>Tillverkaren är inte ansvarig för skada som orsakats av produkten om skadan beror på att produkten har reparerats felaktigt eller om, vid reparation eller utbyte, andra än Original GARDENA reservdelar har använts. Samma sak gäller för kompletteringsdelar och tillbehör.</p>
<p>I <i>Responsabilità del prodotto</i></p>	<p>Si rende espressamente noto che, conformemente alla legislazione sulla responsabilità del prodotto, non si risponde di danni causati da nostri articoli se originati da riparazioni eseguite non correttamente o da sostituzioni di parti effettuate con materiale non originale GARDENA o comunque da noi non approvato e, in ogni caso, qualora l'intervento non venga eseguito da un centro assistenza GARDENA o da personale specializzato autorizzato. Lo stesso vale per le parti complementari e gli accessori.</p>
<p>E <i>Responsabilidad de productos</i></p>	<p>Advertimos que conforme a la ley de responsabilidad de productos no nos responsabilizamos de daños causados por nuestros aparatos, siempre y cuando dichos daños hayan sido originados por arreglos o reparaciones indebidas, por recambios con piezas que no sean piezas originales GARDENA o bien piezas autorizadas por nosotros, así como en aquellos casos en que la reparación no haya sido efectuada por un Servicio Técnico GARDENA o por un técnico autorizado. Lo mismo es aplicable para las piezas complementarias y accesorios.</p>
<p>P <i>Responsabilidade sobre o produto</i></p>	<p>Queremos salientar que segundo a lei da responsabilidade do fabricante, nós não nos responsabilizaremos por danos causados pelo nosso equipamento, quando estes ocorram em decorrência de reparações inadequadas ou da substituição de peças por peças não originais da GARDENA, ou peças não autorizadas. A responsabilidade tornar-se-à nula também depois de reparações realizadas por oficinas não autorizadas pela GARDENA. Esta restrição valerá também para peças adicionais e acessórios.</p>
<p>DK <i>Produktansvar</i></p>	<p>Vi gør udtrykkeligt opmærksom på at i henhold til produktansvarsloven er vi ikke ansvarlige for skader forårsaget af vores udstyr, hvis det skyldes uautoriserede reparationer eller hvis dele er skiftet ud og der ikke er anvendt originale GARDENA dele eller dele godkendt af os, eller hvis reparationerne ikke er udført af GARDENA-service eller en autoriseret fagmand. Det samme gælder for ekstra udstyr og tilbehør.</p>

<p>D EU-Konformitätserklärung Maschinenverordnung (9. GSGVO) / EMVG / Niedersp. RL Der Unterzeichnete GARDENA Manufacturing GmbH, Hans-Lorenser-Str. 40, D-89079 Ulm, bestätigt, dass die nachfolgend bezeichneten Geräte in der von uns in Verkehr gebrachten Ausführung die Anforderungen der harmonisierten EU-Richtlinien, EU-Sicherheitsstandards und produktspezifischen Standards erfüllen. Bei einer nicht mit uns abgestimmten Änderung der Geräte verliert diese Erklärung ihre Gültigkeit.</p>	Bezeichnung des Gerätes: UVC-Unterwasserfilter mit Wasserspumpen-Set Description of the unit: UVC Underwater filter with Fountain Pump Set Désignation du matériel : Filtre immergé UVC avec kit pompe pour jets d'eau Omschrijving van het apparaat: UVC-onderwaterfilter met vijverpompset
<p>GB EU Certificate of Conformity The undersigned GARDENA Manufacturing GmbH, Hans-Lorenser-Str. 40, D-89079 Ulm, hereby certifies that, when leaving our factory, the units indicated below are in accordance with the harmonised EU guidelines, EU standards of safety and product specific standards. This certificate becomes void if the units are modified without our approval.</p>	Produktbeskrivning: UVC-Undervattensfilter med pumpset för fontäner Descrizione del prodotto: Filtro subacqueo UVC con set per giochi d'acqua Descripción de la mercancía: Filtro sumergible UVC con bomba para fuentes de agua Descrição do aparelho: Filtro submersível UVC com conjunto de bombas de jogos de água
<p>F Certificat de conformité aux directives européennes Le constructeur, soussigné : GARDENA Manufacturing GmbH, Hans-Lorenser-Str. 40, D-89079 Ulm, déclare qu'à la sortie de ses usines le matériel neuf désigné ci-dessous était conforme aux prescriptions des directives européennes énoncées ci-après et conforme aux règles de sécurité et autres règles qui lui sont applicables dans le cadre de l'Union européenne. Toute modification portée sur ce produit sans l'accord express de GARDENA supprime la validité de ce certificat.</p>	Beskrivelse af enhederne: UVC-Undervandsfilter med springvandspumpesæt
<p>NL EU-overeenstemmingsverklaring Ondergetekende GARDENA Manufacturing, Hans-Lorenser-Str. 40, D-89079 Ulm, bevestigt, dat de volgende genoemde apparaten in de door ons in de handel gebrachte uitvoering voldoen aan de eis van, en in overeenstemming zijn met de EU-richtlijnen, de EU-veiligheidsstandaard en de voor het product specifieke standaard. Bij een niet met ons afgestemde verandering aan de apparaten verliest deze verklaring haar geldigheid.</p>	Typ: Art.-Nr.: Type: Art. No.: Type : Référence : Type: Art. nr.: Type: FFP 5000 UVC Art.nr.: 7883 Modello: Art. : Tipo: Art. Nº: Tipo: Art. Nº: Type: Varenr. :
<p>S EU Tillverkarintyg Undertecknad firma GARDENA Manufacturing GmbH, Hans-Lorenser-Str. 40, D-89079 Ulm, intygar härmed att nedan nämnda produkter överensstämmer med EU:s direktiv, EU:s säkerhetsstandard och produktspecifikation. Detta intyg upphör att gälla om produkten ändras utan vårt tillstånd.</p>	EU-Richtlijnen: 98/37/EC:1998 Harmonisierte EN: EU directives: 2006/42/EC:2006 EN 60335-1 Directives européennes: 2004/108/EC EN 60335-2-41 EU-richtlijnen: 2006/95/EC EU direktiv: 93/68/EC Direttiva UE: Directrices da UE: EU Retningslinier:
<p>I Dichiarazione di conformità alle norme UE La sottoscritta GARDENA Manufacturing GmbH, Hans-Lorenser-Str. 40, D-89079 Ulm, certifica che il prodotto qui di seguito indicato, nei modelli da noi commercializzati, è conforme alle direttive armonizzate UE nonché agli standard di sicurezza e agli standard specifici di prodotto. Qualunque modifica apportata al prodotto senza nostra specifica autorizzazione invalida la presente dichiarazione.</p>	Anbringningsjahr der CE-Kennzeichnung: Year of CE marking: Date d'apposition du marquage CE : Installatiejaar van de CE-aanduiding: CE-Märkningsår: 2008 Anno di rilascio della certificazione CE: Colocación del distintivo CE: Ano de marcação pela CE: CE-Mærkningsår:
<p>E Declaración de conformidad de la UE El que suscribe GARDENA Manufacturing, Hans-Lorenser-Str. 40, D-89079 Ulm, declara que la presente mercancía, objeto de la presente declaración, cumple con todas las normas de la UE, en lo que a normas técnicas, de homologación y de seguridad se refiere. En caso de realizar cualquier modificación en la presente mercancía sin nuestra previa autorización, esta declaración pierde su validez.</p>	Ulm, den 01.04.2008 Ulm, 01.04.2008 Fait à Ulm, le 01.04.2008 Ulm, 01-04-2008 Ulm, 2008.01.04. Ulm, 01.04.2008 Ulm, 01.04.2008 Ulm, 01.04.2008 Ulm, 01.04.2008 Ulm, 01.04.2008 Der Bevollmächtigte Authorised representative Représentant légal Gemachtigde Behörig Firmatecknare Rappresentante autorizzato Representante autorizado Representante autorizado Teknik direktør
<p>P Certificado de conformidade da UE Os abaixo mencionados GARDENA Manufacturing GmbH, Hans-Lorenser-Str. 40, D-89079 Ulm, por este meio certificam que ao sair da fábrica o aparelho abaixo mencionado está de acordo com as diretrizes harmonizadas da UE, padrões de segurança e de produtos específicos. Este certificado ficará nulo se a unidade for modificada sem a nossa aprovação.</p>	 Peter Lameli Vice President
<p>DK EU Overensstemmelse certificat Undertegnede GARDENA Manufacturing GmbH, Hans-Lorenser-Str. 40, D-89079 Ulm bekræfter hermed, at enheder listet herunder, ved afsendelse fra fabrikken, er i overensstemmelse med harmoniserede EU retningslinier, EU sikkerhedsstandarder og produktspecifikationsstandarder. Dette certifikat træder ud af kraft hvis enhederne er ændret uden vor godkendelse.</p>	

Deutschland / Germany

GARDENA
Manufacturing GmbH
Central Service
Hans-Lorenser-Straße 40
D-89079 Ulm
Produktfragen:
(+49) 731 490-123
Reparaturen:
(+49) 731 490-290
service@gardena.com

Argentina

Husqvarna Argentina S.A.
Vera 745
(C1414AOO) Buenos Aires
Phone: (+54) 11 4858-5000
diego.poggi@ar.husqvarna.com

Australia

Husqvarna Australia Pty. Ltd.
Locked Bag 18
Gosford NSW 2250
Phone: (+61) (0) 2 4372 1500
customer.service@
husqvarna.com.au

Austria / Österreich

Husqvarna Austria GmbH
Consumer Products
Industriezeile 36
4010 Linz
Tel.: (+43) 732 77 01 01 - 90
consumer.service@
husqvarna.at

Belgium

GARDENA Belgium NV/SA
Sterrebeekstraat 163
1930 Zaventem
Phone: (+32) 2 720 92 12
Mail: info@gardena.be

Brazil

Palash Comércio e
Importação Ltda.
Rua São João do Araguaia, 338
- Jardim Califórnia -
Barueri - SP - Brasil -
CEP 06409-060
Phone: (+55) 11 4198-9777
eduardo@palash.com.br

Bulgaria

Хускварна България ЕООД
1799 София
Бул. „Андрей Ляпчев“ № 72
Тел.: (+359) 2 80 99 424
www.husqvarna.bg

Canada

GARDENA Canada Ltd.
100 Summerlea Road
Brampton, Ontario L6T 4X3
Phone: (+1) 905 792 93 30
info@gardenacanada.com

Chile

Antonio Martinic y Cia Ltda.
Cassillas 272
Centro de Cassillas
Santiago de Chile
Phone: (+56) 2 20 10 708
garfar_cl@yahoo.com

Costa Rica

Compania Exim
Euroberoamericana S.A.
Los Colegios, Moravia,
200 metros al Sur del Colegio
Saint Francis - San José
Phone: (+506) 297 68 83
exim_euro@racsa.co.cr

Croatia

KLIS d.o.o.
Stanciceva 79
10419 Vukovina
Phone: (+385) 1 622 777 0
gardena@klis-trgovina.hr

Cyprus

FARMOKIPIKI LTD
P.O. Box 7098
74, Digeni Akritas Ave.
1641 Nicosia
Phone: (+357) 22 75 47 62
condam@spidernet.com.cy

Czech Republic

GARDENA spol. s r.o.
Tuřanka 115
627 00 Brno
Phone: (+420) 548 217 777
gardena@gardenabrno.cz

Denmark

GARDENA
Husqvarna Consumer Outdoor
Products
Salgsafdelning Danmark
Box 9003
S-200 39 Malmö
info@gardena.dk

Estonia

Husqvarna Eesti OÜ
Consumer Outdoor Products
Kesk tee 10, Aaviku küla
Rae vald, Harju maakond
75305
kontakt.etj@husqvarna.ee

Finland

Oy Husqvarna Ab
Consumer Outdoor Products
Lautatarhankatu 8 B / PL 3
00581 HELSINKI
info@gardena.fi

France

GARDENA France
Immeuble Exposial
9 - 11 allée des Pierres Mayettes
ZAC des Barbanniers, B.P. 99
- F - 92232 GENNEVILLIERS
cedex
Tél. (+33) 01 40 85 30 40
service.consommateurs@
gardena.fr

Great Britain

Husqvarna UK Ltd
Preston Road
Aycliffe Industrial Park
Newton Aycliffe
County Durham
DL5 6UP
info.gardena@
husqvarna.co.uk

Greece

HUSQVARNA GREECE S.A.
Branch of Koropi
Ifestou 33A
Industrial Area Koropi
194 00 Athens - Greece
V.A.T. EL094094640
Phone: (+30) 210 66 20 225
info@husqvarna-consumer.gr

Hungary

Husqvarna
Magyarország Kft.
Ezred u. 1 - 3
1044 Budapest
Phone: (+36) 80 20 40 33
gardena@gardena.hu

Iceland

Ó. Johnson & Kaaber
Tunguhalsi 1
110 Reykjavik
ooj@ojk.is

Ireland

Michael McLoughlin & Sons
Hardware Limited
Long Mile Road
Dublin 12

Italy

GARDENA Italia S.p.A.
Via Donizetti 22
20020 Lainate (Mi)
Phone: (+39) 02.93.94.79.1
info@gardenaitalia.it

Japan

KAKUICHI Co. Ltd.
Sumitomo Realty &
Development Kojimachi
BLDG., 8F, 5-1 Nibanncyo,
Chiyoda-ku, Tokyo 102-0084
Phone: (+81) 33 264 4721
m_ishihara@kaku-ichi.co.jp

Latvia

SIA „Husqvarna Latvija“
Consumer Outdoor Products
Bakūžu iela 6, Rīga, LV-1024
info@husqvarna.lv

Lithuania

UAB Husqvarna Lietuva
Consumer Outdoor Products
Atleities pl. 77C
LT-52104 Kaunas
centras@husqvarna.lt

Luxembourg

Magasins Jules Neuberg
39, rue Jacques Stas
Luxembourg-Gasperich 2549
Case Postale No. 12
Luxembourg 2010
Phone: (+352) 40 14 01
api@neuberg.lu

Netherlands

GARDENA Nederland B.V.
Postbus 50176
1305 AD ALMERE
Phone: (+31) 36 521 00 00
info@gardena.nl

Neth. Antilles

Jonka Enterprises N.V.
Sta. Rosa Weg 196
P.O. Box 8200, Curaçao
Phone: (+599) 9 767 66 55
pgm@jonka.com

New Zealand

Husqvarna New Zealand Ltd.
PO Box 76437
Manukau City 2241
Phone: (+64) (09) 92024 10

Norway

GARDENA
Husqvarna Consumer Outdoor
Products
Salgskontor Norge
Klevereveien 6
1540 Vestby
info@gardena.no

Poland

Husqvarna Poland Spółka z o.o.
Oddział w Szymanowie
Szymanów 9 d
05-532 Baniocha
Phone: (+48) 22 727 56 90
gardena@gardena.pl

Portugal

GARDENA Portugal Lda.
Sintra Business Park
Edifício 1, Fracção 0-G
2710-089 Sintra
Phone: (+351) 21 922 85 30
info@gardena.pt

Romania

MADEX INTERNATIONAL SRL
Soseaua Odaii 117-123,
Sector 1,
București, RO 013603
Phone: (+40) 21 352 76 03
madex@ines.ro

Russia

ООО ГАРДЕНА PVC
123007, г. Москва
Хорошевское шоссе, д. 32А
Тел.: (+7) 495 380 31 92
info@gardena-rus.ru

Singapore

Hy - Ray PRIVATE LIMITED
40 Jalan Pemimpin
#02-08 Tat Ann Building
Singapore 577185
Phone: (+65) 6253 2277
shiyang@hyray.com.sg

Slovak Republic

GARDENA spol. s r.o.
Tuřanka 115
627 00 Brno
Phone: (+420) 548 217 777
gardena@gardenabrno.cz

Slovenia

GARDENA d.o.o.
Brodšče 15
1236 Trzin
Phone: (+386) 1 580 93 32
servis@gardena.si

South Africa

GARDENA
South Africa (Pty.) Ltd.
P.O. Box 11534
Vorna Valley 1686
Phone: (+27) 11 315 02 23
sales@gardena.co.za

Spain

GARDENA IBÉRICA S.L.U.
C/ Basauri, nº 6
La Florida
28023 Madrid
Phone: (+34) 91 708 05 00
atencioncliente@gardena.es

Sweden

GARDENA
Husqvarna Consumer Outdoor
Products
Försäljningskontor Sverige
Box 9003
200 39 Malmö
info@gardena.se

Switzerland / Schweiz

Husqvarna Schweiz AG
Consumer Products
Industriestrasse 10
5506 Mägenwil
Phone: (+41) (0) 848 800 464
info@gardena.ch

Turkey

GARDENA / Dost Diş Ticaret
Müessesilik A.Ş. Sanayi
Çad. Adil Sokak No. 1
Kartal - Istanbul
Phone: (+90) 216 38 93 939
info@gardena-dost.com.tr

Ukraine / Україна

ТОВ «ГАРДЕНА УКРАЇНА»
Васильківська, 34, 204-Г
03022, Київ
Тел. (+38 044) 498 39 02
info@gardena.ua

7883-20.960.01/0708
© GARDENA
Manufacturing GmbH
D-89070 Ulm
http://www.gardena.com