

300 Art. 4020
380 Art. 4023

D Betriebsanleitung

Spindelmäher

GB Operating Instructions

Cylinder Lawnmower

F Mode d'emploi

Tondeuse hélicoïdale

NL Instructies voor gebruik

Kooimesmaaier

S Bruksanvisning

Handgräsklippare

I Istruzioni per l'uso

Rasaprato a mano

E Manual de instrucciones

Cortacésped helicoidal

P Instruções de utilização

Cortador de relva cilíndrico

DK Brugsanvisning

Håndplæneklipper

FIN Käyttöohje

Työnnettävä ruohonleikkuri

GARDENA Cylinder Lawnmower 300 / 380

Welcome to the Garden of GARDENA...



Translation of the original instructions from German. Please read these operating instructions carefully and observe the notes given. Use these instructions to familiarise yourself with the cylinder lawnmower, its correct use and the notes on safety.



For safety reasons, children under the age of 16 as well as persons not familiar with these operating instructions should not use this cylinder lawnmower.

→ Please keep these operating instructions in a safe place.

Contents

1. Where to Use Your GARDENA Cylinder Lawnmower	8
2. For Your Safety	8
3. Assembly	9
4. Operation	9
5. Putting into Storage	10
6. Maintenance	10
7. Troubleshooting	10
8. Accessories	12
9. Technical Data	12
10. Service	12

1. Where to Use Your GARDENA Cylinder Lawnmower

Correct use:

The GARDENA Cylinder Lawnmower has been designed for cutting lawn and grass areas of private houses. Compliance with these instructions provided by GARDENA is a prerequisite for using the cylinder lawnmower correctly.

Please note



The cylinder lawnmower may not be used for cutting climbing plants or grass on roofs, due to the danger of bodily harm.

2. For Your Safety

Checks before each operation:

Before use, an inspection is always to be performed. In order to determine that all nuts, bolts and working tools are not worn down or damaged. Worn down or damaged blades are to be replaced in sets.

Inspect the surface on which the lawn mower is to be used beforehand. Stones, pieces of wood and wires as well as other solid matter are to be removed.

Objects, which are contacted by the cutting tools, could be thrown out uncontrollably.

Proper use / Responsibility



WARNING!

Take note that the rotating blade cylinder could cause injuries.

→ Never place your hands or feet on or under moving parts.

Do not use the lawnmower while people, especially children, or animals are nearby. The operator is liable for damages.

The safety distance between the blade cylinder and the operator that is created by the guiding spar is to be always maintained.

When mowing embankments and slopes, special care must be taken:

→ Make sure you always keep a safe distance and wear shoes with a non-slip sole.

Always cut diagonally to the slope.

Take special care when moving backwards and when pulling the lawn mower. Danger of stumbling!

If the cutting tools or the lawnmower run into an obstruction and / or solid objects, the lawn mower should be properly and thoroughly inspected.

→ Only work when visibility is good.

Never leave the lawnmower unattended. If your work is interrupted, store the mower in a safe place.

3. Assembly

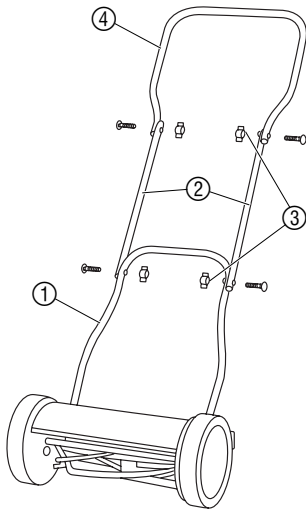

1. Squeeze lower part of upright ① together gently until it snaps into the pins ⑥.
2. Push U-shaped retaining washer ⑤ on to the groove on the bolt ⑥.
3. Screw middle parts of upright ② firmly to lower part of upright ① with 2 wing nuts ③.
4. Screw upper part of upright ④ to middle parts of upright ② with 2 wing nuts ③.

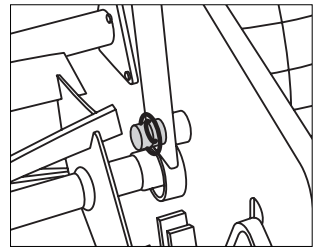
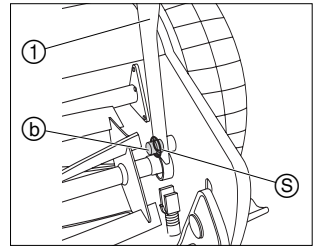

4. Operation

Mowing correctly:

To produce a well-maintained lawn we recommend cutting the lawn regularly once a week if possible. The lawn becomes thicker if cut frequently.

Relatively long cut grass (> 1 cm) must be removed so that the lawn does not become yellow and matted.

After relatively long intervals between mowing (e.g. holiday), first of all cut in one direction with the cutting height as high as possible (42 mm), then cut in the crosswise direction at the cutting height required. The blades of grass should not be more than 12 cm long if they are to be cut with a cylinder mower.

If possible only cut the grass when it is dry. If the grass is damp, the cutting pattern will be uneven.

Adjusting the cutting height:

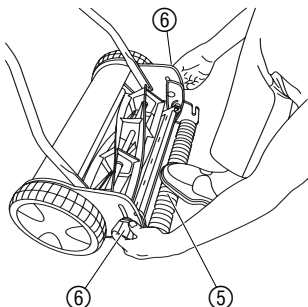

The cutting height can be set to any position between 12 mm and 42 mm.

1. Stand behind the cylinder mower with one foot on the roller ⑤.
2. Release the two locking screws ⑥ and adjust to the correct height in the inspection window ⑦.
3. Tighten the two locking screws ⑥ on both sides to the same height.

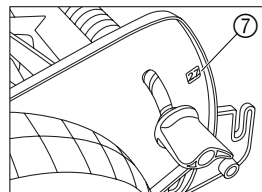

The locking screws ⑥ must always be set to the same height on both sides.

The mower may only be adjusted to a depth in which the lower blade does not touch the ground when it is uneven.

5. Putting into Storage

Storage:

→ Clean cylinder mower before storage (see 5. Maintenance) and store in a dry place.

To save space the cylinder mower can be collapsed by opening up the clamping nuts.

6. Maintenance

Cleaning the mower:



DANGER! Cutting mechanism can cause injuries!

→ Wear suitable work gloves when undertaking maintenance.



WARNING! Damage to cylinder lawnmower.

→ Never clean your cylinder lawnmower with running water, in particular with water under high pressure.

Always keep the lawnmower clean and remove grass deposits. Deposits affect the cutting result as well as discharge of grass clippings. Residual dirt and grass is easily removed immediately after mowing.

1. Remove grass deposits with a brush and a cloth.
2. Oil the red cutting mechanism lightly with thin oil (e.g. sprayed oil).

7. Troubleshooting



DANGER! Cutting tool can cause injuries!

→ Wear suitable work gloves when rectifying faults.

Fault	Possible Cause	Rectification
Abnormal Noises	Screws / components loose.	→ Tighten screws.
	Foreign bodies on the blade.	→ Remove foreign bodies.
	Notch in the blade.	→ Remove notches with grindstone.
	Blades are striking each other too hard.	→ Adjust cutting mechanism.
Lawn is not cleanly cut	Blade adjustment incorrect.	→ Adjust cutting mechanism.
	Blade blunt.	→ Regrind or replace blade.
	Grass too long (e.g. after a relatively long absence).	→ Cut lawn shorter with a sickle.

Adjusting the cutting mechanism:

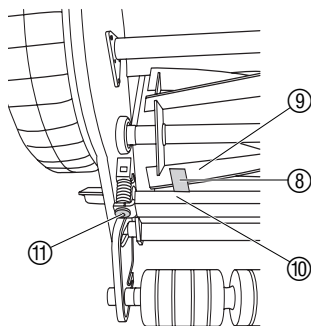

The cutting gear of your lawn mower was optimally adjusted before leaving our company. If, after longer use, a clean cut of the grass is no longer possible or the blade roller contacts the lower blade, then the lower blade should be adjusted as follows:

1. Unhook upright and clean cylinder mower.
2. Check cylinder ⑨ and lower blade ⑩ for notches and remove these with a grindstone if necessary.
3. Unscrew internal hexagon screws ⑪ with an internal hexagon wrench (5 mm) anticlockwise until the cylinder ⑩ turns freely.
4. Push the feeler gauge supplied (thin strip of metal) ⑧ between one blade ⑨ on the cylinder and the lower blade ⑩.
5. Tighten left internal hexagon screw ⑪ with an internal hexagon wrench (5 mm) until the feeler gauge ⑧ is held gently.
6. Continue turning the cylinder until the blade ⑨, already adjusted on the left side, is exactly above the lower blade ⑩ on the right side.
7. Tighten the right internal hexagon screw ⑪ with an internal hexagon wrench (5 mm) until the feeler gauge ⑧ is held gently.
8. Rotate cylinder ⑨. If a banging noise is produced during this, open up the internal hexagon screw ⑪ slightly on the side affected.

When the cylinder and the lower blade can hardly be heard touching each other, the cutting mechanism has been adjusted correctly.

9. Cutting test:

Place a strip of paper ⑫ in such a way on the lower blade ⑩ that it points towards the spindle of the cylinder ⑨.

10. Turn cylinder ⑨ carefully.

If the lower blade is set correctly ⑩ the paper will be cut off as if with scissors.

11. Repeat the cutting test on the other blades ⑨.

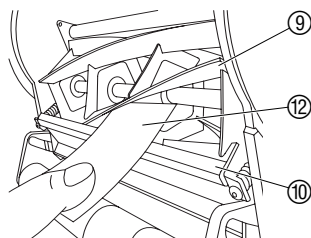



On safety grounds, only original GARDENA spares may be used.

Please contact GARDENA Service if it is necessary to replace the cutting tool, which will only become blunt after several years use if well-maintained. Repairs to the cylinder mower and the installation of the blades can be undertaken by suitable specialist workshops.

Have the cylinder mower checked over in the autumn if possible so that it is ready for use immediately when the next lawn-mowing season starts.

If you have any problem with your cylinder mower, please contact our Customer Service.

8. Accessories

GARDENA Grass collecting bag

Saves raking up the cut grass. **Art. No. 4029**

9. Technical Data

	300 (Art. No. 4020)	380 (Art. No. 4023)
Cutting width / Cutting height	30 cm / 12 - 42 mm	38 cm / 12 - 42 mm
Cutting height adjustment	infinitely variable	infinitely variable
Weight	8.0 kg	8.5 kg

10. Warranty

GARDENA guarantees this product for 2 years (starting from the date of purchase). This guarantee covers all serious defects of the unit that can be proved to be material or manufacturing faults. Under warranty we will either replace the unit or repair it free of charge if the following conditions apply:

- The unit must have been handled properly and in keeping with the requirements of the operating instructions.
- Neither the purchaser or a non-authorised third party have attempted to repair the unit.

The wearing parts blade cylinder (complete) and lower blade are excluded from the warranty.

This manufacturer's guarantee does not affect the user's existing warranty claims against the dealer/seller.

If a fault occurs with your Cylinder Lawn Mower, please return the faulty unit together with a copy of the receipt and a description of the fault, with postage paid to one of the GARDENA Service Centres listed on the back of these operating instructions.

<p>D <i>Produkthftung</i></p>	<p>Wir weisen ausdrücklich darauf hin, dass wir nach dem Produkthaftungsgesetz nicht für durch unsere Geräte hervorgerufene Schäden einzustehen haben, sofern diese durch unsachgemäße Reparatur verursacht oder bei einem Teileaustausch nicht unsere Original GARDENA Teile oder von uns freigegebene Teile verwendet werden und die Reparatur nicht vom GARDENA Service oder dem autorisierten Fachmann durchgeführt wird. Entsprechendes gilt für Ergänzungssteile und Zubehör.</p>
<p>GB <i>Product Liability</i></p>	<p>We expressly point out that, in accordance with the product liability law, we are not liable for any damage caused by our units if it is due to improper repair or if parts exchanged are not original GARDENA parts or parts approved by us, and, if the repairs were not carried out by a GARDENA Service Centre or an authorised specialist. The same applies to spare parts and accessories.</p>
<p>F <i>Responsabilité</i></p>	<p>Nous vous signalons expressément que GARDENA n'est pas responsable des dommages causés par ses appareils, dans la mesure où ces dommages seraient causés suite à une réparation non conforme, dans la mesure où, lors d'un échange de pièces, les pièces d'origine GARDENA n'auraient pas été utilisées, ou si la réparation n'a pas été effectuée par le Service Après-Vente GARDENA ou l'un des Centres SAV agréés GARDENA. Ceci est également valable pour tout ajout de pièces et d'accessoires autres que ceux préconisés par GARDENA.</p>
<p>NL <i>Productaansprakelijkheid</i></p>	<p>Wij wijzen er nadrukkelijk op, dat wij op grond van de wet aansprakelijkheid voor producten niet aansprakelijk zijn voor schade ontstaan door onze apparaten, indien deze door onvakkundige reparatie veroorzaakt zijn, of er bij het uitwisselen van onderdelen geen gebruik gemaakt werd van onze originele GARDENA onderdelen of door ons vrijgegeven onderdelen en de reparatie niet door de GARDENA technische dienst of de bevoegde vakman uitgevoerd werd. Ditzelfde geldt voor extra-onderdelen en accessoires.</p>
<p>S <i>Produktansvar</i></p>	<p>Tillverkaren är inte ansvarig för skada som orsakats av produkten om skadan beror på att produkten har reparerats felaktigt eller om, vid reparation eller utbyte, andra än Original GARDENA reservdelar har använts. Samma sak gäller för kompletteringsdelar och tillbehör.</p>
<p>I <i>Responsabilità del prodotto</i></p>	<p>Si rende espressamente noto che, conformemente alla legislazione sulla responsabilità del prodotto, non si risponde di danni causati da nostri articoli se originati da riparazioni eseguite non correttamente o da sostituzioni di parti effettuate con materiale non originale GARDENA o comunque da noi non approvato e, in ogni caso, qualora l'intervento non venga eseguito da un centro assistenza GARDENA o da personale specializzato autorizzato. Lo stesso vale per le parti complementari e gli accessori.</p>
<p>E <i>Responsabilidad de productos</i></p>	<p>Advertimos que conforme a la ley de responsabilidad de productos no nos responsabilizamos de daños causados por nuestros aparatos, siempre y cuando dichos daños hayan sido originados por arreglos o reparaciones indebidas, por recambios con piezas que no sean piezas originales GARDENA o bien piezas autorizadas por nosotros, así como en aquellos casos en que la reparación no haya sido efectuada por un Servicio Técnico GARDENA o por un técnico autorizado. Lo mismo es aplicable para las piezas complementarias y accesorios.</p>
<p>P <i>Responsabilidade sobre o produto</i></p>	<p>Queremos salientar que segundo a lei da responsabilidade do fabricante, nós não nos responsabilizaremos por danos causados pelo nosso equipamento, quando estes ocorram em decorrência de reparações inadequadas ou da substituição de peças por peças não originais da GARDENA, ou peças não autorizadas. A responsabilidade tornar-se-à nula também depois de reparações realizadas por oficinas não autorizadas pela GARDENA. Esta restrição valerá também para peças adicionais e acessórios.</p>
<p>DK <i>Produktansvar</i></p>	<p>Vi gør udtrykkeligt opmærksom på at i henhold til produktansvarsloven er vi ikke ansvarlige for skader forårsaget af vores udstyr, hvis det skyldes uautoriserede reparationer eller hvis dele er skiftet ud og der ikke er anvendt originale GARDENA dele eller dele godkendt af os, eller hvis reparationerne ikke er udført af GARDENA-service eller en autoriseret fagmand. Det samme gælder for ekstra udstyr og tilbehør.</p>

Deutschland / Germany

GARDENA
Manufacturing GmbH
Central Service
Hans-Lorenser-Straße 40
D-89079 Ulm
Produktfragen:
(+49) 731 490-123
Reparaturen:
(+49) 731 490-290
service@gardena.com

Argentina

Husqvarna Argentina S.A.
Vera 745
(C1414AOO) Buenos Aires
Phone: (+54) 11 4858-5000
diego.poggi@ar.husqvarna.com

Australia

Husqvarna Australia Pty. Ltd.
Locked Bag 18
Gosford NSW 2250
Phone: (+61) (0) 2 4372 1500
customer.service@
husqvarna.com.au

Austria / Österreich

Husqvarna Austria GmbH
Consumer Products
Industriezeile 36
4010 Linz
Tel.: (+43) 732 77 01 01 - 90
consumer.service@
husqvarna.at

Belgium

GARDENA Belgium NV/SA
Sterrebeekstraat 163
1930 Zaventem
Phone: (+32) 2 72092 12
Mail: info@gardena.be

Brazil

Palash Comércio e
Importação Ltda.
Rua São João do Araguaia, 338
- Jardim Califórnia -
Barueri - SP - Brasil -
CEP 06409-060
Phone: (+55) 11 4198-9777
eduardo@palash.com.br

Bulgaria

Хускварна България ЕООД
1799 София
Бул. „Андрей Ляпчев“ № 72
Тел.: (+359) 2 80 99 424
www.husqvarna.bg

Canada

GARDENA Canada Ltd.
100 Summerlea Road
Brampton, Ontario L6T 4X3
Phone: (+1) 905 792 9330
info@gardenacanada.com

Chile

Antonio Martinic y Cia Ltda.
Cassillas 272
Centro de Cassillas
Santiago de Chile
Phone: (+56) 2 20 10 708
garfar_cl@yahoo.com

Costa Rica

Compania Exim
Euroberoamericana S.A.
Los Colegios, Moravia,
200 metros al Sur del Colegio
Saint Francis - San José
Phone: (+506) 297 68 83
exim_euro@racsa.co.cr

Croatia

KLIS d.o.o.
Stanciceva 79
10419 Vukovina
Phone: (+385) 1 622 777 0
gardena@klis-trgovina.hr

Cyprus

FARMOKIPIKI LTD
P.O. Box 7098
74, Digeni Akritas Ave.
1641 Nicosia
Phone: (+357) 22 75 47 62
condam@spidernet.com.cy

Czech Republic

GARDENA spol. s r.o.
Tuřanka 115
627 00 Brno
Phone: (+420) 548 217 777
gardena@gardenabrno.cz

Denmark

GARDENA
Husqvarna Consumer Outdoor
Products
Salgsafdelning Danmark
Box 9003
S-200 39 Malmö
info@gardena.dk

Estonia

Husqvarna Eesti OÜ
Consumer Outdoor Products
Kesk tee 10, Aaviku küla
Rae vald, Harju maakond
75305
kontakt.etj@husqvarna.ee

Finland

Oy Husqvarna Ab
Consumer Outdoor Products
Lautatarhankatu 8 B / PL 3
00581 HELSINKI
info@gardena.fi

France

GARDENA France
Immeuble Exposial
9 - 11 allée des Pierres Mayettes
ZAC des Barbanniers, B.P. 99
- F - 92232 GENNEVILLIERS
cedex
Tél. (+33) 01 40 85 30 40
service.consommateurs@
gardena.fr

Great Britain

Husqvarna UK Ltd
Preston Road
Aycliffe Industrial Park
Newton Aycliffe
County Durham
DL5 6UP
info.gardena@
husqvarna.co.uk

Greece

HUSQVARNA GREECE S.A.
Branch of Koropi
Ilfestou 33A
Industrial Area Koropi
194 00 Athens - Greece
V.A.T. EL094094640
Phone: (+30) 210 66 20 225
info@husqvarna-consumer.gr

Hungary

Husqvarna
Magyarország Kft.
Ezred u. 1 - 3
1044 Budapest
Phone: (+36) 80 20 40 33
gardena@gardena.hu

Iceland

Ó. Johnson & Kaaber
Tunguhalsi 1
110 Reykjavik
ooj@ojk.is

Ireland

Michael McLoughlin & Sons
Hardware Limited
Long Mile Road
Dublin 12

Italy

GARDENA Italia S.p.A.
Via Donizetti 22
20020 Lainate (Mi)
Phone: (+39) 02.93.94.79.1
info@gardenaitalia.it

Japan

KAKUICHI Co. Ltd.
Sumitomo Realty &
Development Kojimachi
BLDG., 8F, 5-1 Nibanncyo,
Chiyoda-ku, Tokyo 102-0084
Phone: (+81) 33 264 4721
m_ishihara@kaku-ichi.co.jp

Latvia

SIA „Husqvarna Latvija“
Consumer Outdoor Products
Bakūžu iela 6, Rīga, LV-1024
info@husqvarna.lv

Lithuania

UAB Husqvarna Lietuva
Consumer Outdoor Products
Atleities pl. 77C
LT-52104 Kaunas
centras@husqvarna.lt

Luxembourg

Magasins Jules Neuberg
39, rue Jacques Stas
Luxembourg-Gasperich 2549
Case Postale No. 12
Luxembourg 2010
Phone: (+352) 40 14 01
api@neuberg.lu

Netherlands

GARDENA Nederland B.V.
Postbus 50176
1305 AD ALMERE
Phone: (+31) 36 521 00 00
info@gardena.nl

Neth. Antilles

Jonka Enterprises N.V.
Sta. Rosa Weg 196
P.O. Box 8200, Curaçao
Phone: (+599) 9 767 66 55
pgm@jonka.com

New Zealand

Husqvarna New Zealand Ltd.
PO Box 76437
Manukau City 2241
Phone: (+64) (09) 92024 10

Norway

GARDENA
Husqvarna Consumer Outdoor
Products
Salgskontor Norge
Klevereveien 6
1540 Vestby
info@gardena.no

Poland

Husqvarna Poland Spółka z o.o.
Oddział w Szymanowie
Szymanów 9 d
05-532 Baniocha
Phone: (+48) 22 727 56 90
gardena@gardena.pl

Portugal

GARDENA Portugal Lda.
Sintra Business Park
Edifício 1, Fracção 0-G
2710-089 Sintra
Phone: (+351) 21 922 85 30
info@gardena.pt

Romania

MADEX INTERNATIONAL SRL
Soseaua Odaii 117-123,
Sector 1,
București, RO 013603
Phone: (+40) 21 352 76 03
madex@ines.ro

Russia

ООО ГАРДЕНА PVC
123007, г. Москва
Хорошевское шоссе, д. 32А
Тел.: (+7) 495 380 31 92
info@gardena-rus.ru

Singapore

Hy - Ray PRIVATE LIMITED
40 Jalan Pemimpin
#02-08 Tat Ann Building
Singapore 577185
Phone: (+65) 6253 2277
shiyang@hyray.com.sg

Slovak Republic

GARDENA spol. s r.o.
Tuřanka 115
627 00 Brno
Phone: (+420) 548 217 777
gardena@gardenabrno.cz

Slovenia

GARDENA d.o.o.
Brodšče 15
1236 Trzin
Phone: (+386) 1 580 93 32
servis@gardena.si

South Africa

GARDENA
South Africa (Pty.) Ltd.
P.O. Box 11534
Vorna Valley 1686
Phone: (+27) 11 315 02 23
sales@gardena.co.za

Spain

GARDENA IBÉRICA S.L.U.
C/ Basauri, nº 6
La Florida
28023 Madrid
Phone: (+34) 91 708 05 00
atencioncliente@gardena.es

Sweden

GARDENA
Husqvarna Consumer Outdoor
Products
Försäljningskontor Sverige
Box 9003
200 39 Malmö
info@gardena.se

Switzerland / Schweiz

Husqvarna Schweiz AG
Consumer Products
Industriestrasse 10
5506 Mägenwil
Phone: (+41) (0) 848 800 464
info@gardena.ch

Turkey

GARDENA / Dost Diş Ticaret
Müessesilik A.Ş. Sanayi
Çad. Adil Sokak No. 1
Kartal - Istanbul
Phone: (+90) 216 38 93 939
info@gardena-dost.com.tr

Ukraine / Україна

ТОВ «ГАРДЕНА УКРАЇНА»
Васильківська, 34, 204-Г
03022, Київ
Тел. (+38 044) 498 39 02
info@gardena.ua

4020-20.960.06/0908
© GARDENA
Manufacturing GmbH
D-89070 Ulm
http://www.gardena.com