

X372340052(801)



GB

OWNER'S MANUAL



CHAIN SAW

GZ400

Important!

It is essential that read the instructions in this manual before mounting and operating this machine.

EXPLANATION OF SYMBOLS AND SAFETY WARNINGS

Read, understand and follow all warnings.



Read operator's instruction book before operating this machine.



Wear head, eye and ear protection.



Wear non-slip, heavy-duty protective gloves when handling the chain saw.



Warning! Danger of kickback.



Do not operate the saw properly with both hands.



Avoid bar nose contact.



Hold and operate the saw properly with both hands.

**WARNING!!!**

RISK OF DAMAGING HEARING
Wear head, eye and ear protection.



MODEL	SOUND LEVEL			VIBRATION LEVEL	
	ISO 22868		2000/14/EC	ISO 22867	
GZ400	L _{pA}	L _{wA}	L _{wA}	Front handle	Rear handle
	103 dB(A)	112 dB(A)	113 dB(A)	6.4 m/s ²	7.0 m/s ²

APPROVAL NUMBER OF CE EXHAUST EMISSION REGULATION (2002/88/EC)

e1*97/68SH2-IIA*2004/26*0405*00

DECLARATION OF CONFORMITY TO MACHINES DIRECTIVE

(Directive 98/37/EC, 2002/83/EC, 89/336/EEC) ,2000/14/EC
and to the regulations governing transposition
Internal control production

MANUFACTURER : Husqvarna Zenoah Co., Ltd.
No. 9, 1-Chome
MINAMIDAI, KAWAGOE City
SAITAMA, JAPAN

DECLARES THAT THE DESIGN OF THE MACHINE DESCRIBED BELOW:

Model : GZ400
Serial no. : 0801000001 and up
Make : Husqvarna Zenoah Co., Ltd.

CONFORMS TO REQUIREMENTS OF THE MODIFIED MACHINES DIRECTIVE
(Directive 98/37/EC), EN ISO 11681-1:2004; EN ISO 22868:2005; EN ISO
22867:2004; EN 55012:2002; EN ISO 14982:1998 AND TO THE NATIONAL
REGULATIONS GOVERNING ITS TRANSPOSITION ABROAD: AND

THAT IT HAS BEEN ISSUED WITH A, CE CERTIFICATE, BY INTERTEK
DENTSCHLAND GmbH.

The engineering type licence no. (issued by Intertek Deutschland GmbH is
07SHW0982-01.

Measured sound power level:112bB(A)
Guaranteed sound power level; 113bB(A)

Maintenance of technical documentation:

Signed in Saitama, Japan **Jan. 1st 2008**



Masahiko GOUDA
General Manager, Quality Assurance Department

Contents

1. For Safe Operation	4
2. Explanation of Symbols on the Machine	6
3. Installing Guide Bar and Saw Chain	7
4. Fuel and Chain Oil	8
5. Operating the Engine	9
6. Sawing	11
7. Maintenance	12
8. Maintenance of Saw Chain and Guide Bar	13
9. Storage	14
10. Troubleshooting Guide	14
11. Specifications	15

1. For safe operation



1. Never operate a chain saw when you are fatigued, ill, or upset, or under the influence of medication that may make you drowsy, or if you are under the influence of alcohol or drugs.

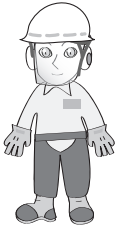

2. Use safety footwear, snug fitting clothing and eye, hearing and head protection devices. Use the vibration-proof glove.

3. Keep the saw chain sharp and the saw, including the AV system, well maintained. A dull chain will increase cutting time, and pressing a dull chain through wood will increase the vibrations transmitted to your hands. A saw with loose components or with damaged or worn AV buffers will also tend to have higher vibration levels.

4. All the above mentioned precautions do not guarantee that you will not sustain whitefinger disease or carpal tunnel syndrome. Therefore, continual and regular users should monitor closely the condition of their hands and fingers. If any of the above symptoms appear, seek medical advice immediately.



5. Always use caution when handling fuel. Wipe up all spills and then move the chain saw at least 3 m from the fueling point before starting the engine.



6. Eliminate all sources of sparks or flame (i.e. smoking, open flames, or work that can cause sparks) in the areas where fuel is mixed, poured, or stored.

7. Do not smoke while handling fuel or while operating the chain saw.

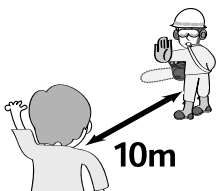

8. Do not allow other persons to be near the chain saw when starting or cutting. Keep bystanders and animals out of the work area. Children, pets and bystanders should be a minimum of 10 m away when you start or operate the chain saw.

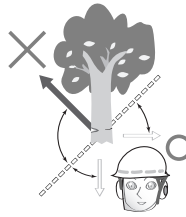

9. Never start cutting until you have a clear work area, secure footing, and a planned retreat path from the falling tree.



10. Always hold the chain saw firmly with both hands when the engine is running. Use a firm grip with thumb and fingers encircling the chain saw handles.

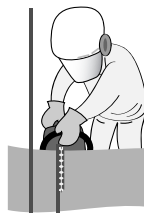

11. Keep all parts of your body away from the saw chain when the engine is running.



12. Before you start the engine, make sure the saw chain is not contacting anything.

13. Always carry the chain saw with the engine stopped, the guide bar and saw chain to the rear, and the muffler away from your body.



14. Always inspect the chain saw before each use for worn, loose, or damaged parts. Never operate a chain saw that is damaged, improperly adjusted, or is not completely and securely assembled. Be sure that the saw chain stops moving when the throttle control trigger is released.



15. All chain saw service, other than the items listed in the Owner's Manual, should be performed by competent chain saw service personnel. (E.g., if improper tools are used to remove the flywheel, or if an improper tool is used to hold the flywheel in order to remove the clutch, structural damage to the flywheel could occur)

which could subsequently cause the flywheel to disintegrate.)

16. Always shut off the engine before setting it down.



17. Use extreme caution when cutting small size brush and saplings because slender material may catch the saw chain and be whipped toward you or pull you off balance.

18. When cutting a limb that is under tension, be alert for spring-back so that you will not be struck when the tension in the wood fibers is released.

19. Never cut in high wind, bad weather, when visibility is poor or in very high or low temperatures. Always check the tree for dead branches which could fall during the felling operation.



20. Keep the handles dry, clean and free of oil or fuel mixture.



21. Operate the chain saw only in well ventilated areas. Never start or run the engine inside a closed room or building. Exhaust fumes contain dangerous carbon monoxide.

22. Do not operate the chain saw in a tree unless specially trained to do so.

23. Guard against kickback. Kickback is the upward motion of the guide bar which occurs when the saw chain at the nose of the guide bar contacts an object. Kickback can lead to dangerous loss of control of the chain saw.



24. When transporting your chain saw, make sure the appropriate guide bar scabbard is in place.

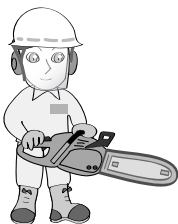

KICKBACK SAFETY PRECAUTIONS FOR CHAIN SAW USERS

WARNING

- Kickback may occur when the nose or tip of the guide bar touches an object, or when the wood closes in and pinches the



saw chain in the cut. Tip contact in some cases may cause a lightning fast reverse reaction, kicking the guide bar up and back towards the operator. Pinching the saw chain along the top of the guide bar may push the guide bar rapidly back towards the operator. Either of these reactions may cause you to lose control of the saw, which could result in serious personal injury.

- Do not rely exclusively on the safety devices built into your saw. As a chain saw user you should take several steps to keep cutting jobs free from accident or injury.

(1) With a basic understanding of kickback you can reduce or eliminate the element of surprise. Sudden surprise contributes to accidents.

(2) Keep a good grip on the saw with both hands, the right hand on the rear handle, and the left hand on the front handle, when the engine is running. Use a firm grip with thumbs and fingers encircling the chain saw handles. A firm grip will help you reduce kickback and maintain control of the saw.

(3) Make certain that the area in which you are cutting is free from obstructions. Do not let the nose of the guide bar contact a log, branch, or any other obstruction which could be hit while you are operating the saw.

(4) Cut at high engine speeds.

(5) Do not overreach or cut above shoulder height.



(6) Follow the manufacturer's sharpening and maintenance instructions for the saw chain.

(7) Only use replacement bars and chains specified by the manufacturer or the equivalent.



2. Explanation of Symbols on the Machine



For safe operation and maintenance, symbols are carved in relief on the machine.
According to these indications, please be careful not to make any mistake.



The port to refuel "MIX GASOLINE"

Position: Fuel cap



The port to top up chain oil

Position: Oil cap



Setting the switch to the "O" position, the engine stops immediately.

Position: Rear-left of the unit

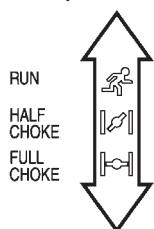

Starting the engine. If you pull out the choke knob (at the back-right of the rear handle) to the point of the arrow, you can set the starting mode as follows:

- *HALF CHOKE* – starting mode when the engine is warm.
- *FULL CHOKE* – starting mode when the engine is cold.

Position: Upper-right of the aircleaner cover

H

The screw under the "H" stamp is The High-speed adjustment screw.

L

The screw under the "L" stamp is The Slow-speed adjustment screw.

T

The screw at the left of the "T" stamp is the Idle adjustment screw.

Position: Left side of the rear handle



Shows the directions that the chain brake is released (white arrow) and activated (black arrow).

Position: Front of the chain cover

3. Installing Guide Bar and Saw Chain

A standard saw unit package contains the items as illustrated.

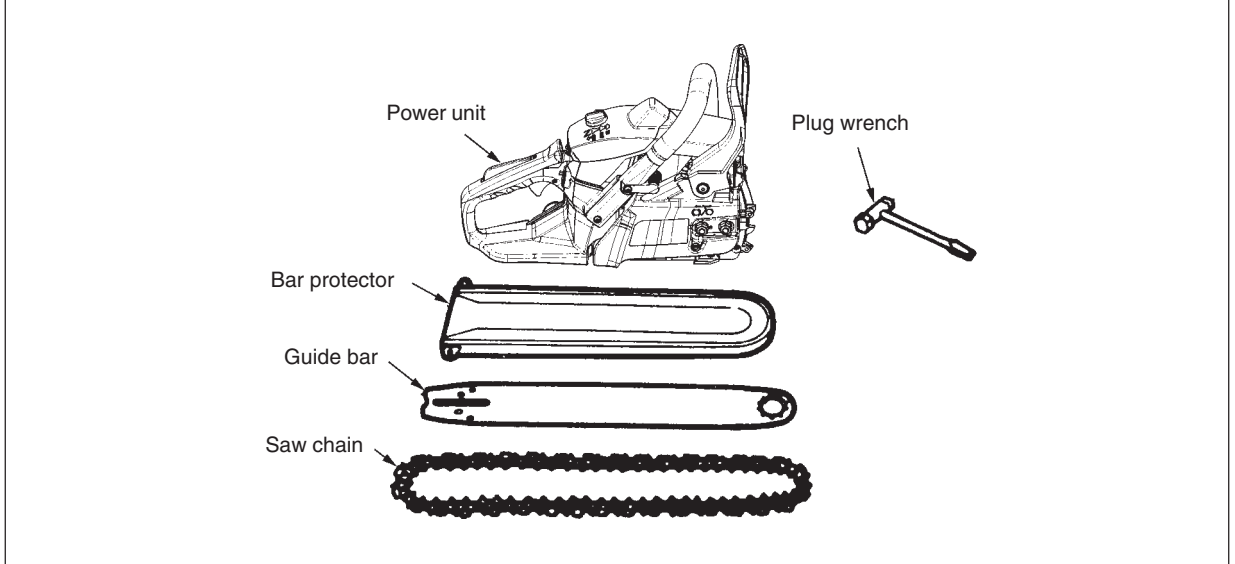

Open the box and install the guide bar and the saw chain on the power unit as follows:

! The saw chain has very sharp edges. Use thick protective gloves for safety.

1. Pull the guard towards the front handle to check that the chain brake is not engaged.
2. Loosen the nuts and remove the chain cover.
3. Gear the chain to the sprocket and, while fitting the saw chain around the guide bar, mount the guide bar to the power unit. Adjust the position of the chain tensioner.

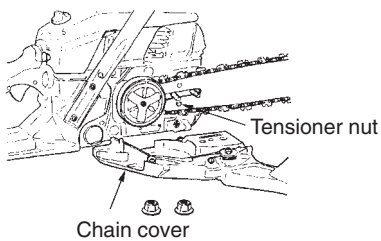

Note: Pay attention to the correct direction of the saw chain.

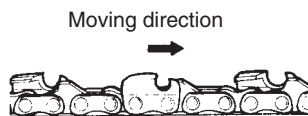

4. Fit the chain cover to the power unit and fasten the nuts to finger tightness.
5. While holding up the tip of the bar, adjust the chain tension by turning the tensioner screw until the tie straps just touch the bottom side of the bar rail.

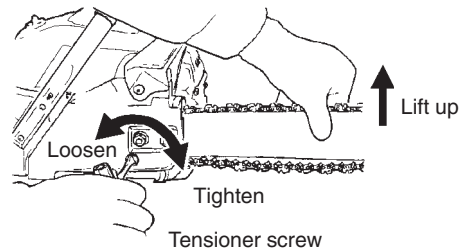

6. Tighten the nuts securely with the bar tip held up (12 ~ 15 N·m). Then check the chain for smooth rotation and proper tension while moving it by hand. If necessary, readjust with the chain cover loose.
7. Tighten the tensioner screw.

Note: A new chain will expand its length in the beginning of use. Check and readjust the tension frequently as a loose chain can easily derail or cause rapid wear of itself and the guide bar.

4. Fuel and Chain Oil

■ FUEL

⚠ WARNING

- Gasoline is very flammable. Avoid smoking or bringing any flame or sparks near fuel. Make sure to stop the engine and allow it cool before refueling the unit. Select outdoor bare ground for fueling and move at least 3 m (10 ft) away from the fueling point before starting the engine.



- The Zenoah engines are lubricated by oil specially formulated for air-cooled 2-cycle gasoline engine use. If Zenoah oil is not available, use an anti-oxidant added quality oil expressly labeled for air-cooled 2-cycle engine use (JASO FC GRADE OIL or ISO EGC GRADE).
- Do not use BIA or TCW (2-stroke water-cooling type) mixed oil.



■ RECOMMENDED MIXING RATIO GASOLINE 50 : OIL 1

(when using ZENOAH genuine oil)

- Exhaust emission are controlled by the fundamental engine parameters and components (eq., carburation, ignition timing and port timing) without addition of any major hardware or the introduction of an inert material during combustion.
- These engines are certified to operate on unleaded gasoline.
- Make sure to use gasoline with a minimum octane number of 89RON (USA/Canada: 87AL).
- If you use a gasoline of a lower octane value than prescribed, there is a danger that the engine temperature may rise and an engine problem such as piston seizing may consequently occur.
- Unleaded gasoline is recommended to reduce the contamination of the air for the sake of your health and the environment.
- Poor quality gasolines or oils may damage sealing rings, fuel lines or fuel tank of the engine.

■ HOW TO MIX FUEL



- Pay attention to agitation.

- Measure out the quantities of gasoline and oil to be mixed.
- Put some of the gasoline into a clean, approved fuel container.
- Pour in all of the oil and agitate well.

- Pour in the rest of gasoline and agitate again for at least one minute. As some oils may be difficult to agitate depending on oil ingredients, sufficient agitation is necessary for the engine to last long. Be careful that, if the agitation is insufficient, there is an increased danger of early piston seizing due to abnormally lean mixture.
- Put a clear indication on the outside of the container to avoid mixing up with gasoline or other containers.
- Indicate the contents on outside of container for easy identification.

■ FUELING THE UNIT

- Untwist and remove the fuel cap. Rest the cap on a dustless place.
- Put fuel into the fuel tank to 80% of the full capacity.
- Fasten the fuel cap securely and wipe up any fuel spillage around the unit.



⚠ WARNING

- Select flat and bare ground for fueling.
- Move at least 10 feet (3 meters) away from the fueling point before starting the engine.
- Stop the engine before refueling the unit. At that time, be sure to sufficiently agitate the mixed gasoline in the container.

■ FOR YOUR ENGINE LIFE, AVOID:

- FUEL WITH NO OIL (RAW GASOLINE) – It will cause severe damage to the internal engine parts very quickly.
- GASOHOL – It can cause deterioration of rubber and/or plastic parts and disruption of engine lubrication.
- OIL FOR 4-CYCLE ENGINE USE – It can cause spark plug fouling, exhaust port blocking, or piston ring sticking.
- Mixed fuels which have been left unused for a period of one month or more may clog the carburetor and result in the engine failing to operate properly.
- In the case of storing the product for a long period of time, clean the fuel tank after rendering it empty. Next, activate the engine and empty the carburetor of the composite fuel.
- In the case of scrapping the used mixed oil container, scrap it only at an authorized repository site.

Note: As for details of quality assurance, read the description in the section Limited Warranty carefully. Moreover, normal wear and change in product with no functional influence are not covered by the warranty. Also, be careful that, if the usage in the instruction manual is not observed as to the mixed gasoline, etc. described therein, it may not be covered by the warranty.

■ CHAIN OIL

Use special chain saw oil or synthetic 2-stroke oil.

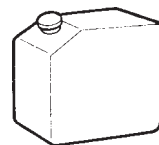

Note: Do not use wasted or regenerated oil that can cause damage to the oil pump.

5. Operating the Engine



It is very dangerous to run a chainsaw that mounts broken parts or lacks any parts. Before starting engine, make sure that all the parts including bar and chain are installed properly.

■ STARTING THE ENGINE

1. Fill fuel and chain oil tanks respectively, and tighten the caps securely.

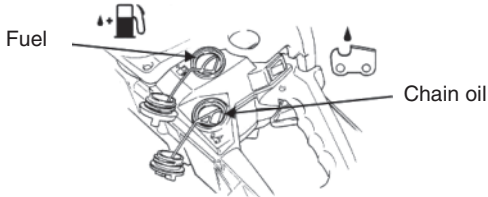

2. Set the switch to "I" position.

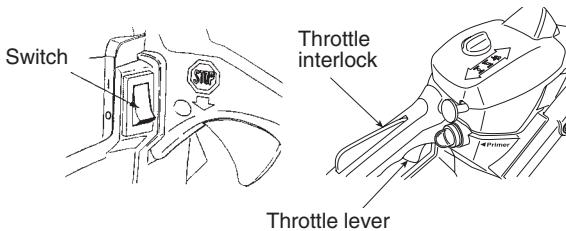

3. Continuously push the primer until fuel comes in the bulb.

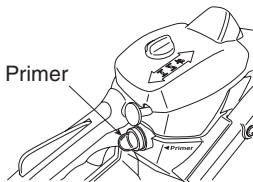

4. Pull the choke knob all the way out to FULL CHOKE position.

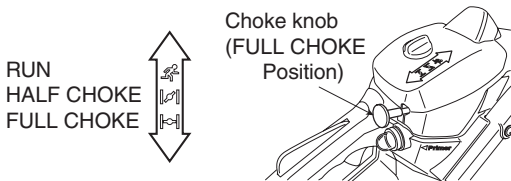

5. While holding the saw unit securely on the ground, pull the starter grip until the engine attempts to start, but no more than 5 times.

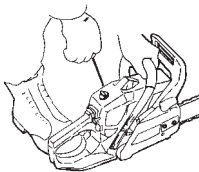

Do not start the engine while the chain saw hangs in one hand. The saw chain may touch your body. This is very dangerous.

6. Push the choke knob to HALF CHOKE position.
7. Pull starter grip until engine runs.

Note: Allow the saw to run in this position 15-30 seconds, depending upon the temperature.

8. Push the choke knob in to the RUN position.

Note: When restarting immediately after stopping the engine, set the Choke knob in the HALF CHOKE position (choke open and throttle lever in the starting position).



Keep clear of the saw chain as it will start rotating upon starting of engine.

■ CHECKING THE OIL SUPPLY



Make sure to set up the bar and the chain when checking the oil supply. If not, the rotating parts may be exposed. It is very dangerous.

After starting the engine, run the chain at medium speed and see if chain oil is scattered off as shown in the figure.

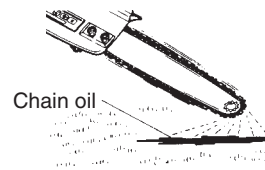

Note: The oil tank should become nearly empty by the time fuel is used up. Be sure to refill the oil tank every time when refueling the saw.

■ ADJUSTING THE CARBURETOR

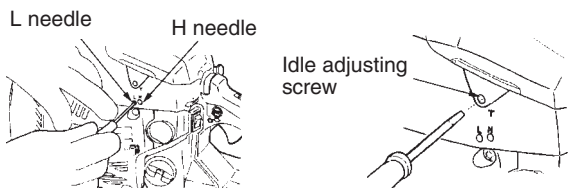

The carburetor on your unit has been factory adjusted, but may require fine tuning due to a change in operating conditions.

Before adjusting the carburetor, make sure that the provided air/fuel filters are clean and fresh and the fuel properly mixed.

When adjusting, take the following steps:

Note: Be sure to adjust the carburetor with the bar chain attached.

Fine adjustment of the idling speed T

Adjust the idle speed with the T-screw. If it is necessary to readjust, turn the T-screw clockwise while the engine is running, until the chain starts to rotate. Then turn counter-clockwise until the chain stops. A correctly adjusted idle speed setting occurs when the engine runs smoothly in every position. It should also be good margin to the rpm when the chain starts to rotate.

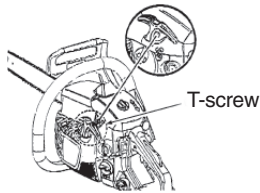

Contact your servicing dealer, if the idle speed setting cannot be adjusted so that the chain stops. Do not use the chain saw until it has been properly adjusted or repaired.

CHAIN BRAKE

This machine is equipped with an automatic brake to stop saw chain rotation upon occurrence of kickback during saw cutting. The brake is automatically operated by inertial force, which acts on the weight fitted inside the front guard.

This brake can also be operated manually with the front guard turned down to the guide bar.

To release the brake, pull up the front guard toward the front handle till a "click" sound is heard.

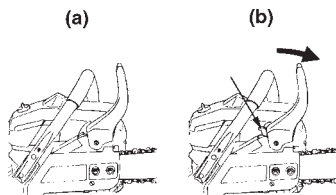

[Caution]

Be sure to confirm brake operation during daily inspection.

How to confirm:

- 1) Turn off the engine.
- 2) Holding the chain saw horizontally, release your hand from the front handle, hit the tip of the guide bar to a stump or a piece of wood, and confirm brake operation. Operating level varies by bar size.

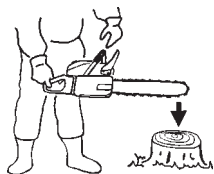

In case the brake is not effective, ask our dealer for inspection and repairs.

If the engine keeps rotating at high speed with the brake engaged, the clutch will overheat causing trouble.

When the brake engages during operation, immediately release the throttle lever to stop the engine.

STOPPING THE ENGINE

1. Release the throttle lever to allow the engine to idle for a few minutes.
2. Set the switch to the "O" (STOP) position.

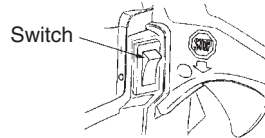

[Important]

Do not put the chain saw on the ground when the chain is still moving. For additional safety, set the chain brake when the saw is not in use. In the event that the ignition switch will not stop the saw, pull the choke knob out to the fully extended position "**FULL CHOKE**" and engage chain brake to stop the engine. If the ignition switch will not stop the saw when set to the "**STOP**" position, have the ignition switch repaired before using the chain saw again to prevent unsafe conditions or serious injury.

Note: When you are finished using the saw, always relieve tank pressure by loosening, then retightening, the chain oil and fuel mix caps. Allow the engine to cool before storing.

Carburetor anti-freeze mechanism

Operating chain saws in temperatures of 0 – 5°C at times of high humidity may result in ice forming within the carburetor, and this in turn may cause the output power of the engine to be reduced or for the engine to fail to operate smoothly.

This product has accordingly been designed with a ventilation hatch on the right side of the surface of the cylinder cover to allow warm air to be supplied to the engine and to thereby prevent icing from occurring. Under normal circumstances the product should be used in the normal operating mode, i.e., in the mode to which it is set at the time of shipment. However when the possibility exists that icing may occur, the unit should be set to operate in the anti-freeze mode before use.

Normal operating mode Anti-freeze mode

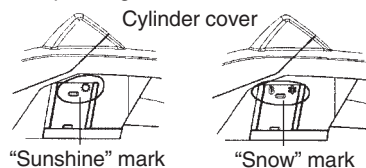

Continuing to use the product in the anti-freeze mode even when temperatures have risen and returned to normal, may result in the engine failing to start properly or in the engine failing to operate at its normal speed, and for this reason you should always be sure to return the unit to the normal operating mode if there is no danger of icing occurring.

HOW TO SWITCH BETWEEN OPERATING MODES

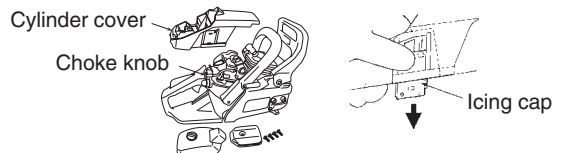

1. Flip the engine switch to turn off the engine.
2. Remove the cover to the air filter, remove the air filter, and then remove the choke knob from the cylinder cover.
3. Loosen the screws holding the cylinder cover in place (i.e., the three screws on the inside and the one screw on the outside of the cover), and then remove the cylinder cover.
4. Press with your finger down on the icing cap located on the right-hand side of the cylinder cover to remove the icing cap.
5. Adjust the icing cap so that the "snow" mark faces upwards and then return it to its original position in the cylinder cover.
6. Fix the cylinder cover back into its original position, and then fix all other parts back into their proper positions.

6. Sawing



- Before proceeding to your job, read the section "For Safe Operation". It is recommended to first practice sawing easy logs. This also helps you get accustomed to your unit.



- Always follow the safety regulations. The chain saw must only be used for cutting wood. It is forbidden to cut other types of material. Vibrations and kickback vary with different materials and the requirements of the safety regulations would not be respected. Do not use the chain saw as a lever for lifting, moving or splitting objects. Do not lock it over fixed stands. It is forbidden to hitch tools or applications to the PTO other than those specified by the manufacturer.

- It is not necessary to force the saw into the cut. Apply only light pressure while running the engine at full throttle.
- When the saw chain is caught in the cut, do not attempt to pull it out by force, but use a wedge or a lever to open the way.

■ GUARD AGAINST KICKBACK

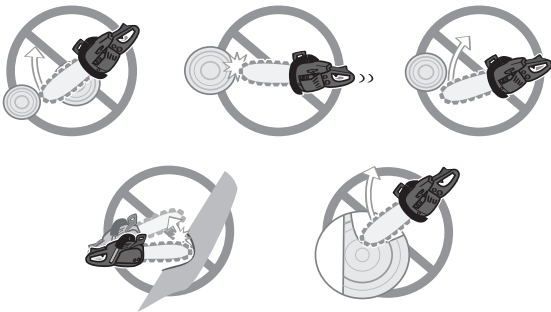

- This saw is equipped with a chain brake that will stop the chain in the event of kickback if operating properly. You must check the chain brake operation before each usage by running the saw at full the throttle for 1 - 2 seconds and pushing the front hand guard forward. The chain should stop immediately with the en-

gine at full speed. If the chain is slow to stop or does not stop, replace the brake band and clutch drum before use.

- It is extremely important that the chain brake be checked for proper operation before each use and that the chain be sharp in order to maintain the kickback safety level of this saw. Removal of the safety devices, inadequate maintenance, or incorrect replacement of the bar or chain may increase the risk of serious personal injury due to kickback.



■ FELLING A TREE

Felling direction ←

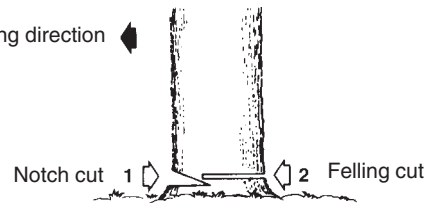

1. Decide the felling direction considering the wind, lean of the tree, location of heavy branches, ease of completing the task after felling and other factors.
2. While clearing the area around the tree, arrange a good foothold and retreat path.
3. Make a notch cut one-third of the way into the tree on the felling side.
4. Make a felling cut from the opposite side of the notch and at a level slightly higher than the bottom of the notch.



When you fell a tree, be sure to warn neighboring workers of the danger.

Bucking and Limbing



- Always ensure your foothold. Do not stand on the log.
- Be alert to the rolling over of a cut log. Especially when working on a slope, stand on the uphill side of the log.
- Follow the instructions in "For Safe Operation" to avoid kickback of the saw.

Before starting work, check the direction of bending force inside the log to be cut. Always finish cutting from the opposite side of the bending direction to prevent the guide bar from being caught in the cut.

A log lying on the ground

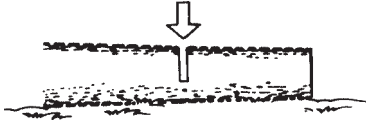

Saw down halfway, then roll the log over and cut from the opposite side.

A log hanging off the ground

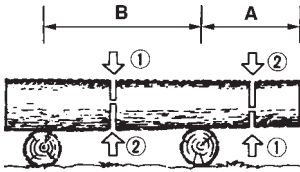

In area A, saw up from the bottom one-third and finish by sawing down from the top. In area B, saw down from the top one-third and finish by sawing up from the bottom.

Cutting the limbs of Fallen Tree

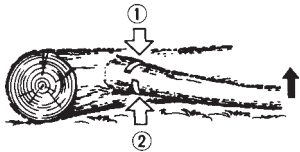

First check to which side the limb is bent. Then make the initial cut from the bent side and finish by sawing from the opposite side.



Be alert to the springing back of a cut limb.

Pruning of Standing Tree

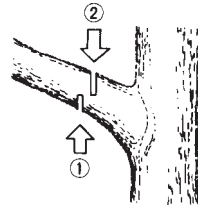

Cut up from the bottom, finish down from the top.



- Do not use an unstable foothold or ladder.
- Do not overreach.
- Do not cut above shoulder height.
- Always use both your hands to hold the saw.

7. Maintenance



Before cleaning, the inspecting or repairing the unit, make sure that engine has stopped and is cool. Disconnect the spark plug to prevent accidental starting.

■ MAINTENANCE AFTER EACH USE

1. Air filter

Dust on the cleaner surface can be removed by tapping a corner of the cleaner against a hard surface. To clean dirt in the meshes, split the cleaner into halves and brush in gasoline. When using compressed air, blow from the inside.

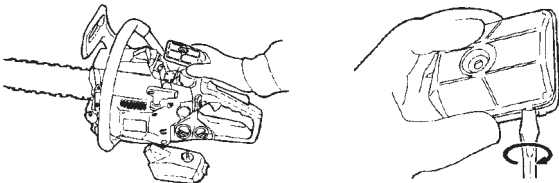

To assemble the cleaner halves, press the rim until it clicks.

Note: When installing the main filter, make sure that the grooves on the filter edge are correctly fit with the projections on the cylinder cover.

2. Oiling port

Dismount the guide bar and check the oiling port for clogging.

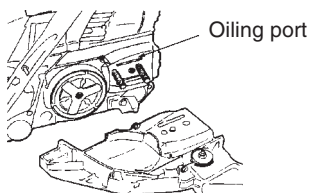

3. Guide bar

When the guide bar is dismantled, remove sawdust in the bar groove and the oiling port.

Grease the nose sprocket from the feeding port on the tip of the bar.

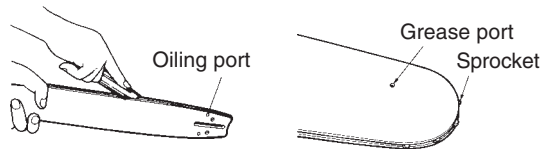

4. Others

Check for fuel leakage and loose fastenings and damage to major parts, especially handle joints and guide bar mounting. If any defects are found, make sure to have them repaired before operating the saw again.

■ PERIODICAL SERVICE POINTS

1. Air cooling system

Dust clogging around the cooling system and the cylinder fins will cause overheating of the engine. Periodically check and clean the cooling system and the cylinder fins with a brush after removing the cylinder cover, the air cleaner and the recoil case. When installing the cylinder cover and the cooling system, make sure that switch wires and grommets are positioned correctly in place.

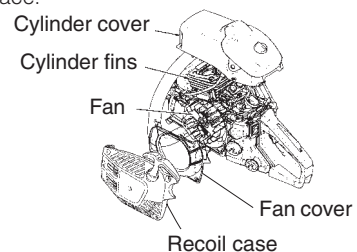

Note: Be sure to block the air intake hole.

2. Spark arrester

The muffler is equipped with a spark arrester to prevent red hot carbon from flying out of the exhaust outlet. Periodically check and clean as necessary with a wire brush after removing two muffler cover nuts and one screw.

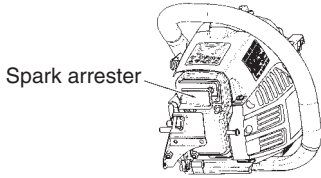

Spark arrester

Note: Never use a muffler if the spark arrester is missing or defective.

3. Exhaust port

Remove the muffler, insert a screwdriver into the vent, and wipe away any carbon buildup after every 100 hours of use. Wipe away any carbon buildup on the muffler exhaust vent and the cylinder exhaust port at the same time.

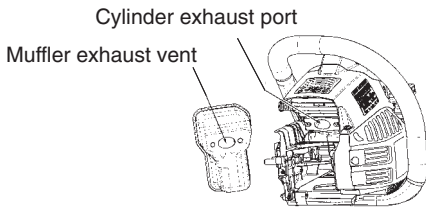

Cylinder exhaust port

Muffler exhaust vent

4. Fuel filter

(a) Using a wire hook, take out the filter from the filler port.

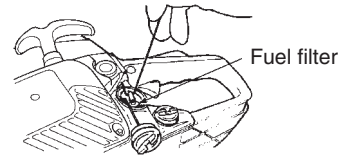

(b) Disassemble the filter and wash with gasoline, or replace with a new one if needed.

Note:

- After removing the filter, use a pinch to hold the end of the suction pipe.
- When assembling the filter, take care not to allow filter fibers or dust inside the suction pipe.

5. Spark plug

0.6-0.7mm



• Champion RZ7C

Clean the electrodes with a wire brush and reset the gap to 0.65 mm as necessary.

6. Sprocket

0.5mm

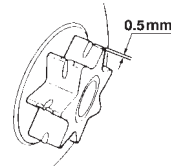

Check for cracks and for excessive wear interfering with the chain drive. If the wear is considerable, replace it with new one. Never fit a new chain on a worn sprocket, or a worn chain on a new sprocket.

8. Maintenance of Saw Chain and Guide Bar

■ Saw Chain



It is very important for smooth and safe operation to always keep the cutters sharp.

The cutters need to be sharpened when:

- Sawdust becomes powder-like.
- You need extra force to saw in.
- The cut path does not go straight.
- Vibration increases.
- Fuel consumption increases.

Cutter setting standards:



Be sure to wear safety gloves.

Before filing:

- Make sure the saw chain is held securely.
- Make sure the engine is stopped.
- Use a round file of proper size for the chain.

Chain type: Carlton N1C-BL-M-57E-SK

File size: 5/32 in (1.6 mm)

Place the file on the cutter and push straight forward. Keep the file position as illustrated.

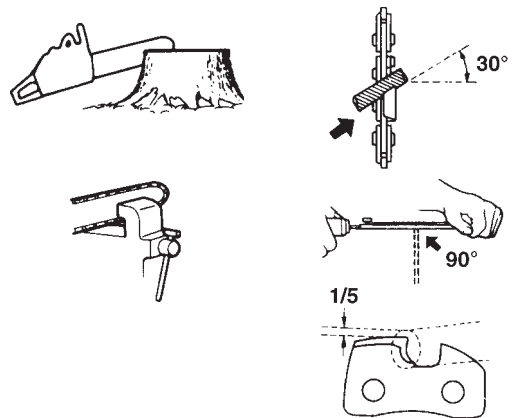

After each cutter has been filed, check the depth gauge and file it to the proper level as illustrated.



Appropriate gauge checker

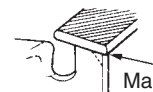

Make the shoulder round

.025" (0.64 mm)

Depth gauge standard



! Be sure to round off the front edge to reduce the chance of kickback or tie-strap breakage.

Make sure every cutter has the same length and edge angles as illustrated.

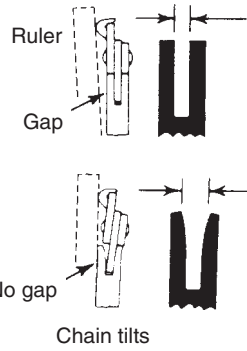
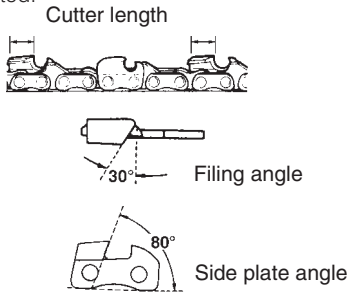

■ Guide Bar

- Reverse the bar occasionally to prevent partial wear.
- The bar rail should always be square. Check for wear of the bar rail. Apply a ruler to the bar and the outside of a cutter. If a gap is observed between them, the rail is normal. Otherwise, the bar rail is worn. Such a bar needs to be corrected or replaced.



WARNING:

This saw is equipped with one of the following low kickback bar/chain combinations:

Saw Model	Bar Size	Zenoah Part Number	
		Guide Bar	Saw Chain
GZ400	16"	16-10-N1-MHC UNB G	N1C-BL-M-57E SK

9. Storage

Aged fuel is one of major causes of engine starting failure. Before storing the unit, empty the fuel tank and run the engine until it uses all the fuel left in the fuel line and the carburetor. Store the unit indoor taking necessary measures for rust prevention.

10. Troubleshooting Guide

Case 1. Starting failure

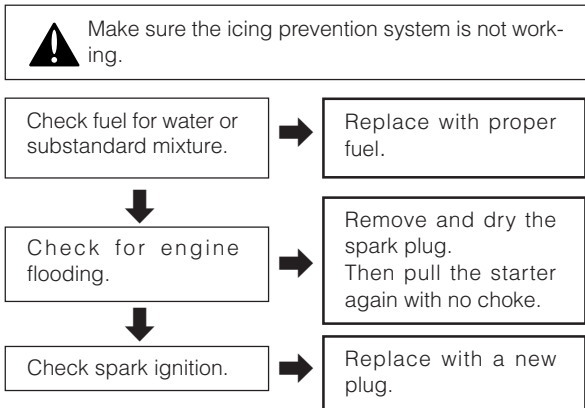

Case 3. Oil does not come out

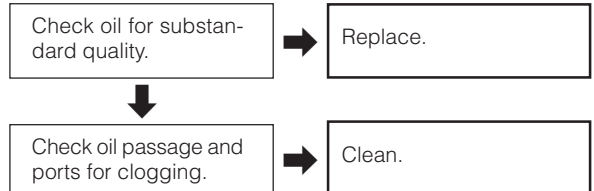

If the unit seems to need further service, please consult with an authorized service shop in your area.

Case 2. Lack of power/Poor acceleration/ Rough idling

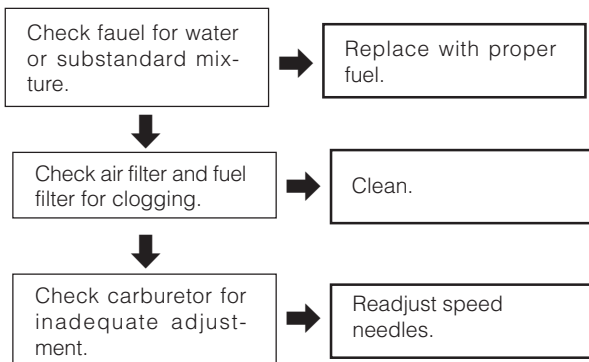

11. Specifications

Power unit:

Displacement (cm³): 40.1
 Fuel: Mixture (Gasoline 50 : Two-cycle oil 1)
 (when using ZENOAH genuine oil)
 Fuel tank capacity (cm³): 310
 Chain oil: special chain saw oil
 or synthetic 2-stroke oil
 Oil tank capacity (cm³): 210
 Carburetor: Diaphragm type (ZAMA C1Q)
 Ignition system: Pointless (CDI)
 Spark plug: Champion RZ7C
 Oil feeding system: Automatic pump
 Power 1.77/10,000 (kw/min⁻¹)
 Max speed 12,000 (min⁻¹)
 Idle speed 2,700 (min⁻¹)
 Sprocket (Teeth x Pitch): 6T x 3/8"

Specific fuel consumption at maximum
 engine power 435g/kWh
 Dimensions (L x W x H) (mm): 370 x 235 x 270
 Dry weight
 Power unit only (kg): 4.60

Cutting head:

Guide bar
 Type: Carlton 16-10-N1-MHC UNB
 Usable cutting lengths (in. (mm)): 370mm
 Saw chain
 Type: Carlton N1C-BL-M-57E SK
 Pitch (in. (mm)): 3/8 (9.53)
 Gauge (in. (mm)): 0.05 (1.27)

Specifications are subject to change without notice.

Limited warranty

Should any failure occur on the product under normal operating conditions within the applicable warranty period, the failed part will be replaced or repaired free of charge by a ZENOAH authorized dealer.

WARRANTY PERIOD: 1 year (6 months if used professionally, and 30 days if used for rental purpose) from the date of initial purchase.

THE PURCHASER SHALL BEAR COSTS OF TRANSPORTING THE UNIT TO AND FROM THE ZENOAH DEALER.

THE PURCHASER SHALL NOT BE CHARGED FOR DIAGNOSTIC LABOR WHICH LEADS TO THE DETERMINATION THAT A WARRANTED PART IS DEFECTIVE, IF THE DIAGNOSTIC WORK IS PERFORMED AT THE ZENOAH DEALER.

THE PURCHASER OR OWNER IS RESPONSIBLE FOR THE PERFORMANCE OF THE REQUIRED MAINTENANCE AS DEFINED BY THE MANUFACTURER IN THE OWNER/OPERATOR MANUAL.

ANY WARRANTED PART WHICH IS NOT SCHEDULED FOR REPLACEMENT AS REQUIRED MAINTENANCE, OR WHICH IS SCHEDULED ONLY FOR REGULAR INSPECTION TO THE EFFECT OF REPAIR OR "REPLACE AS NECESSARY" SHALL BE WARRANTED FOR THE WARRANTY PERIOD. ANY WARRANTED PART WHICH IS SCHEDULED FOR REPLACEMENT AS REQUIRED MAINTENANCE SHALL BE WARRANTED FOR THE PERIOD OF TIME UP TO THE FIRST SCHEDULED REPLACEMENT POINT FOR THE PART.

ANY REPLACEMENT PART THAT IS EQUIVALENT IN PERFORMANCE AND DURABILITY MAY BE USED IN NON-WARRANTY MAINTENANCE OR REPAIRS, AND

SHALL NOT REDUCE THE WARRANTY OBLIGATION OF THE COMPANY.

THE COMPANY IS LIABLE FOR DAMAGES TO OTHER ENGINE COMPONENTS CAUSED BY THE FAILURE OF A WARRANTED PART STILL UNDER WARRANTY.

THE WARRANTY DOES NOT APPLY TO THOSE UNITS WHICH HAVE BEEN DAMAGED BY NEGLIGENCE OF INSTRUCTION LISTED IN THE OWNER/OPERATOR MANUAL FOR PROPER USE AND MAINTENANCE OF THE UNITS ACCIDENT MISHANDLING, ALTERATION, ABUSE, IMPROPER LUBRICATION, USE OF ANY PARTS OR ACCESSORIES OTHER THAN THOSE SPECIFIED BY THE COMPANY, OR OTHER CAUSES BEYOND THE COMPANY'S CONTROL.

THIS WARRANTY DOES NOT COVER THOSE PARTS REPLACED BY NORMAL WEAR OR HARMLESS CHANGES IN THEIR APPEARANCE.

THERE ARE NO OTHER EXPRESS WARRANTIES.

IMPLIED WARRANTIES INCLUDING THOSE OF MERCHANTABILITY AND FITNESS FOR A PARTICULAR PURPOSE **ARE LIMITED** TO TWO (2) YEARS OF HOME USE [ONE (1) YEAR FOR ANY OTHER USE] FROM THE ORIGINAL DELIVERY DATE.

LIABILITIES FOR INCIDENTAL OR CONSEQUENTIAL DAMAGE UNDER ANY AND ALL WARRANTIES ARE EXCLUDED.

IF YOU NEED TO OBTAIN MORE INFORMATION, PLEASE CALL YOUR NEAREST SERVICE CENTER, OR CHECK PLEASE ZENOAH WEB SITE
<http://www.zenoah.net>