

Art. 2693

D	Montageanleitung Wandschlauchtrommel
GB	Assembly Instructions Wall Mounted Hose Reel
F	Instructions de montage Dévidoir mural portable
NL	Montage-instructie Wandslanghouder
S	Monteringsanvisning Slangvinda 2-i-ett
I	Istruzioni di montaggio Avvolgitubo con supporto murale
E	Instrucciones de montaje Soporte mural para manguera portátil
P	Instruções de montagem Tambor para mangueira de parede
DK	Monteringsvejledning Slangeholder til væg

D**Wandschlauchhalter montieren:**

1. Untere Halterung ① mit den **mitgelieferten 6-mm-Dübeln** und Schrauben ② waagrecht an eine Wand schrauben.
2. Schlauchträger in die untere Halterung ① einsetzen und die beiden Bohrungen für die obere Halterung ③ markieren.
Die obere Halterung ③ mit den **mitgelieferten 6-mm-Dübeln** und Schrauben ④ an die Wand schrauben.
3. Schlauchträger in beide Halterungen ①/③ einsetzen und mit dem Hebel ⑤ sichern.

GB**Mounting the Wall Hose Bracket:**

1. Fasten the lower mount ① horizontally to a wall using the **6 mm dowels** and screws ② **provided**.
2. Insert the hose carrier into the lower mount ① and mark the position of the two drill holes for the upper mount ③.
Fasten the upper mount ③ to the wall using the **6 mm dowels** and screws ④ **provided**.
3. Insert the hose carrier into both mounts ①/③ and secure in place with the lever ⑤.

F**Fixation du dévidoir mural :**

1. Fixez horizontalement à un mur le support inférieur ① avec les **chevilles 6 mm** et vis ② **fournies**.
2. Introduisez le dévidoir dans le support inférieur ① et marquez les deux alésages pour le support supérieur ③.
Fixez au mur le support supérieur ③ avec les **chevilles 6 mm** et vis ④ **fournies**.
3. Introduisez le dévidoir dans les deux supports ①/③ et bloquez-le avec le levier ⑤.

NL**Wandslanghouder monteren:**

1. Onderste houder ① met de **meegeleverde 6 mm pluggen** en schroeven ② horizontaal tegen een wand schroeven.
2. Slangdrager in de onderste houder ① plaatsen en de beide gaten voor de bovenste houder ③ markeren.
De bovenste houder ③ met de **meegeleverde 6 mm pluggen** en schroeven ④ tegen de wand schroeven.
3. Slangdrager in beide houders ①/③ plaatsen en met de hendel ⑤ vastzetten.

S**Montering av väggmonterad slanghållare:**

1. Skruva fast det undre fästet ① vågrätt på en vägg med de **bifogade 6 mm pluggarna** och skruvarna ②.
2. Skjut in slanghållaren i den undre fästet ① och markera de båda hålen för det övre fästet ③.
Skruva fast det övre fästet ③ på väggen med de **bifogade 6 mm pluggarna** och skruvarna ④.
3. Skjut in slanghållaren i de båda fästena ①/③ och säkra den med spaken ⑤.

I**Montaggio del reggi-carrello:**

1. Fissare a parete il supporto inferiore ①, in posizione orizzontale, usando i **tasselli da 6 mm** e le viti ② in dotazione.
2. Poggiare il carrello sul supporto inferiore ①; posizionare il supporto superiore ③ al centro del manico del carrello, avvicinarlo alla parete e, con una matita, segnare i punti in cui eseguire i due fori. Fissare quindi a parete il supporto superiore ③ usando i **tasselli da 6 mm** e le viti ④ in dotazione.
3. Inserire il carrello nei supporti ① e ③) e bloccarlo con il fermo ⑤.

E**Montar el soporte mural para manguera:**

1. Fijar el soporte inferior ① en posición horizontal en la pared con los **tacos** y tornillos **de 6 mm** ②, que se adjuntan.
2. Poner el soporte portamanguera en el soporte inferior ① y marcar los dos agujeros para el soporte superior ③.
Fijar el soporte superior ③ en la pared con los **tacos** y tornillos **de 6 mm** ④, que se adjuntan.
3. Poner el soporte portamanguera en ambos soportes ①/③ y sujetarlo con la palanca ⑤.

P**Montagem do suporte de mangueira de parede:**

1. Aparafuse o suporte inferior ① horizontalmente à parede, através das **buchas** e parafusos **de 6 mm** ② **fornecidos**.
2. Insira o porta-mangueira no suporte inferior ① e marque os dois furos para o suporte superior ③.
Aparafuse o suporte superior ③ à parede, através das **buchas** e parafusos **de 6 mm** ④ **fornecidos**.
3. Insira o porta-mangueira em ambos os suportes ①/③ e segure-o mediante a alavanca ⑤.

DK**Montering af slangeholder til væg:**

1. Den nederste holder ① skrues vandret på en væg med de **medleverede 6 mm-dyvlér** og skruerne ②.
2. Slangebæreren anbringes i den nederste holder ① og begge borer til den øverste holder ③ markeres.
Den øverste holder ③ skrues på væggen med de **medleverede 6 mm-dyvlér** og skruerne ④.
3. Slangebæreren anbringes i begge holdere ①/③ og sikres med håndtaget ⑤.

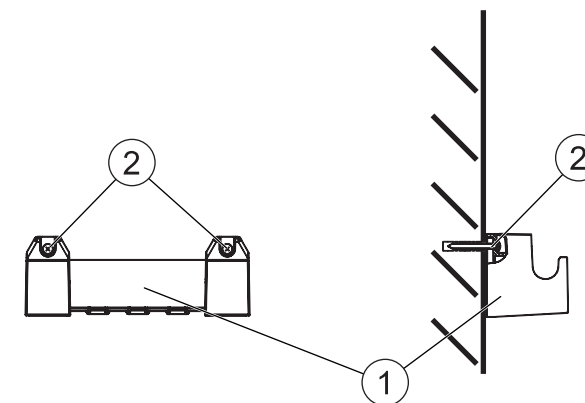
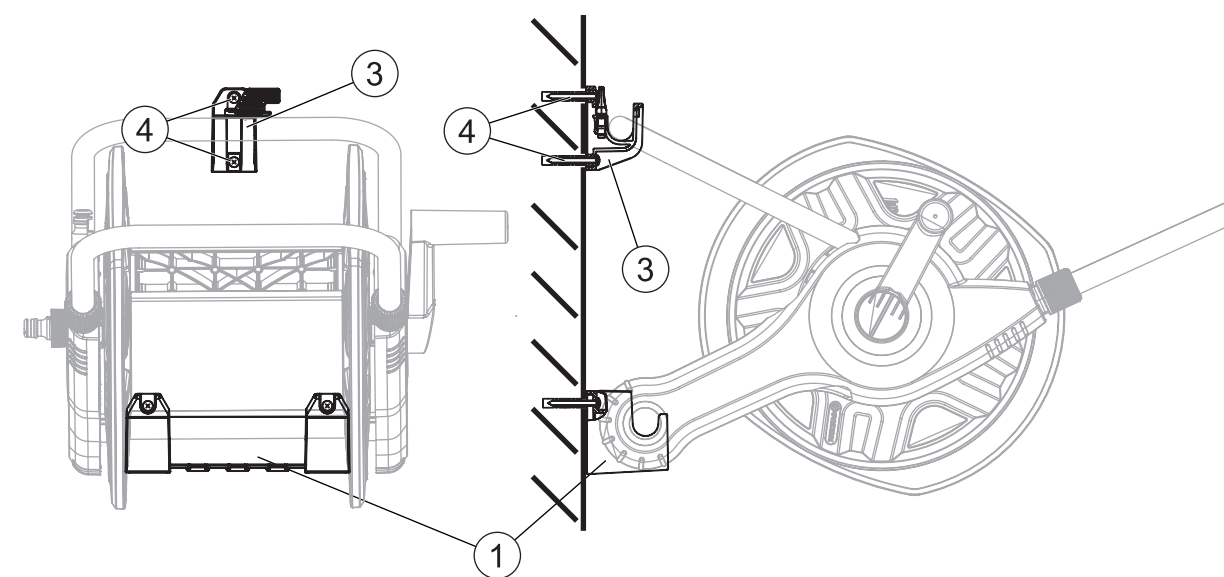
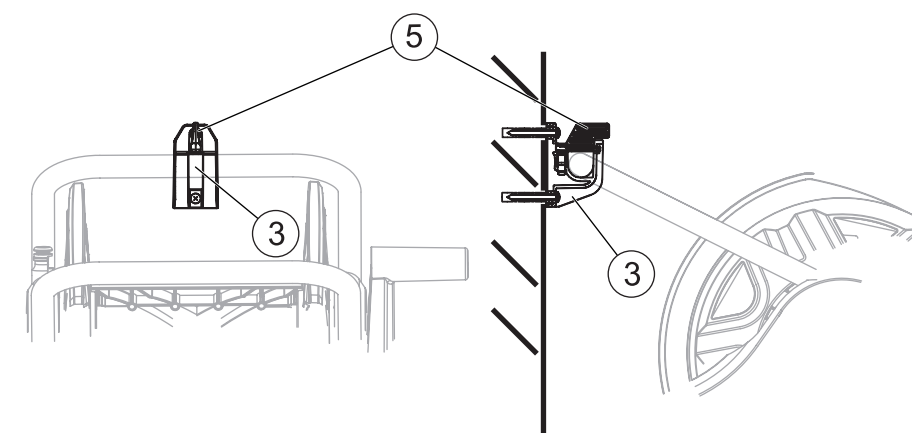
1**2****3**

Service

Deutschland / Germany

GARDENA
Manufacturing GmbH
Service Center
Hans-Lorenser-Str. 40
89079 Ulm
Produktfragen:
(+49) 731 490-123
Reparaturen:
(+49) 731 490-290
service@gardena.com

Argentina

Argensem de Comercializadora
Mecafron S.A.
Casilla de Correo 193
(1625) Escobar, Pcia. de Buenos Aires
Phone: (+54) 34 88 49 40 40
info@argensem.com.ar

Australia

NYLEX Consumer Products
50 – 70 Stanley Drive
Somerton, Victoria, 3062
Phone: 1800 658 276
spare.parts@nylex.com.au

Austria / Österreich

GARDENA Österreich
Ges. m.b.H.
Stettnerweg 11 – 15
2100 Korneuburg
Tel.: (+43) 22 62 745 45-36 od. -30
kundendienst@gardena.at

Belgium

GARDENA Belgium NV/SA
Sterrebeekstraat 163
1930 Zaventem
Phone: (+32) 27 20 921 2
info@gardena.be

Brazil

Palash Importação
e Comércio Ltda
Rua São João do Araguaia, 338
Barueri – SP – CEP: 06409-060
Phone: (+55) 11 4198-9777
eduardo@palash.com.br

Bulgaria

Husqvarna Bulgaria Eood
72 Andrey Ljapchev Blvd.
1799 Sofia

Canada

GARDENA Canada Ltd.
100 Summerlea Road
Brampton, Ontario L6T 4X3
Phone: (+1) 905 792 9330
info@gardenacanada.com

Chile

Garden Chile S.A.
San Sebastián 2839
Ofic. 701 A
Las Condes - Santiago de Chile
Phone: (+56) 220 10 708
garfar_cl@yahoo.com

Costa Rica

Compania Exim
Euroiberoamericana S.A.
Aptdo Postal 1260
San José
Phone: (+506) 223 20 75
exim_euro@racsa.co.cr

Croatia

KLIS d.o.o.
Stančićeva 79
10419 Vukovina
Phone: (+385) 1 622 777 0
gardena@klis-trgovina.hr

Cyprus

FARMOKIPIKI LTD
P.O. Box 7098
74, Digeni Akrita Ave.
1641 Nicosia
Phone: (+357) 22 75 47 62
condam@spidernet.com.cy

Czech Republic

GARDENA spol. s.r.o.
Tuřanka 115
62700 Brno
Phone: (+420) 800 100 425
(Hotline)
gardena@gardenabrno.cz

Denmark

GARDENA Norden AB
Sales Office Denmark
Box 9003
S-200 39 MALMÖ
info@gardena.dk

Finland

Oy Husqvarna Ab
Lautatarhankatu 8b/PL 3
FI-00581 HELSINKI
Phone: (+358) 9 247 2200

France

GARDENA France
PARIS NORD 2
69, rue de la Belle Etoile
BP 57080 ROISSY EN FRANCE
95948 ROISSY CDG CEDEX
Tél. : (+33) 0826 101 455
service.consommateurs@
gardena.fr

Great Britain

GARDENA
Preston Road
Aycliffe Industrial Park
Newton Aycliffe
Co Durham
DL5 6UP
info@gardena.co.uk

Greece

Agrokip-Psomadopoulos S. A.
33 A, Ifestou str.
Industrial Area
194 00 Koropi, Athens
Phone: (+30) 210 66 20-225
and -226
service@agrokip.gr

Hungary

GARDENA Magyarország Kft.
Késmárk utca 22
1158 Budapest
Phone: (+36) 80 20 40 33 (Hotline)
gardena@gardena.hu

Iceland

Ó. Johnson & Kaaber
Tunguhalsi 1
110 Reykjavik

Ireland

McLoughlins RS
Unit 5
Norther Cross Business Park
North Road, Finglas
Dublin 11

Italy

GARDENA Italia S.p.A.
Via Donizetti 22
20020 Lainate (Mi)
Phone: (+39) 02.93.94.79.1
info@gardenaitalia.it

Japan

KAKUICHI co., Ltd.
Sumitomo Realty & Development
Kojimachi
BLDG., 8F
5 – 1 Nibanncyo, chiyoda-ku,
Tokyo 102-0084
Phone: (+81)-(0)3-3264-4721
m_ishihara@kaku-ichi.co.jp

Luxembourg

Magasins Jules Neuberger
39, rue Jacques Stas
Luxembourg-Gasperich 2549
Case Postale No. 12
Luxembourg 2010
Phone: (+352) - 40 14 01
api@neuberger.lu

Netherlands

GARDENA Nederland B.V.
Postbus 50176
1305 AD ALMERE
Phone: (+31) 36 521 00 00
info@gardena.nl

Neth. Antilles

Jonka Tuincentrum
Sta. Rosa Weg 196
P.O. Box 8200
Curaçao
Phone: (+599) 9 767 66 55
pgm@jonka.com

New Zealand

NYLEX New Zealand Ltd.
Building 2
118 Savill Drive
Mangere, Auckland
Phone: 0800 22 00 88
spare.parts@nylex.com.au

Norway

GARDENA Norden AB
Sales Office Norway
Karihaugveien 89
1089 OSLO

Poland

GARDENA Polska Sp. z o.o.
Szymanów 9d
05-532 Baniocha
Phone: (+48) 22 727 56 90
gardena@gardena.pl

Portugal

GARDENA Portugal Lda.
Edif. GARDENA
Algueirão
2725-596 Mem Martins
Phone: 219228530
info@gardena.pt

Romania

MADEX INTERNATIONAL SRL
Șoseaua Odăii 117 – 123
Sector 1, București,
RO 013603
Phone: (+40) 21 352-7603/4/5/6
madex@gardena.ro

Russia / Россия

ООО «ГАРДЕНА РУС»
Хорошевское шоссе, д. 32А
123 007 г. Москва
Phone: +7 (495) 540 99 57

Singapore

HY-RAY PRIVATE LIMITED
40 JALAN PEMIMPIN
#02-08 Tat Ann Building
Singapore 577185
Phone: (+65) 625 32 277
hyray@singnet.com.sg

Serbia

DOMEL d.o.o.
Savski Nasip 7
11070 Novi Beograd
Serbia
Phone: (+381) 11 2772 204
miroslav.jejina@domel.co.yu

Slovenia

GARDENA d.o.o.
Brodišče 15
1236 Trzin
Phone: (+386) 1 580 93 32
servis@gardena.si

South Africa

GARDENA
South Africa (Pty.) Ltd.
P.O. Box 11534
Vorna Valley 1686
Phone: (+27) 11 315 02 23
sales@gardena.co.za

Spain

GARDENA IBÉRICA S.L.U.
C/Basauri, nº 6
La Florida
28023 Madrid
Phone: (+34) 91 708 05 00
(4 líneas)
atencioncliente@gardena.es

Sweden

GARDENA Norden AB
Försäljningskontor Sverige
Box 9003
20039 Malmö
info@gardena.se

Switzerland / Schweiz

GARDENA (Schweiz) AG
Brüelstrasse 4
8157 Dielsdorf
Tel.: 01/860 26 66
info@gardena.ch

Turkey

GARDENA Dost Dış Ticaret
Müessellik A.Ş.
Sanayi Çad. Adil Sok. No. 1
34873 Kartal – Istanbul
Phone: (+90) 216 38 93 939
info@gardena-dost.com.tr

Ukraine / Україна

GARDENA Ukraine Ltd.
4 Petropavlivska Street
Petropavlivska Borschahivka
Town
08130 Kyivo Svyatoshyn
Region
Phone: +380 44 4595703
info@gardena.ua

USA

GARDENA
Melnor, 3085 Shawnee Drive
Winchester, VA 22601
Phone: (540) 722-9080
service_us@melnor.com

2693-20.961.01/1207
© GARDENA Manufacturing GmbH
D-89070 Ulm
http://www.gardena.com