

BRUSHCUTTER ATTACHMENT

ENGLISH

Instruction Manual
Manual de Instrucciones
Manuel d'Instructions

U4000C

NOT DESIGNED FOR USE WITH
ELECTRIC POWERHEADS

NO ESTA DISEÑADO PARA EL USO CON
CABEZAS DE MOTOR ELÉCTRICO

NON CONÇU POUR L'USAGE AVEC
BLOC-MOTEURS ÉLECTRIQUES

ESPAÑOL



DANGER:

Read and follow all Safety Rules and Operating Instructions before using this product. Failure to do so can result in serious injury.

PELIGRO:

Lea el manual de instrucciones y siga todas las advertencias e instrucciones de seguridad. El no hacerlo puede resultar en lesiones graves.

DANGER:

Lire le manuel d'instructions et bien respecter tous les avertissements et toutes les instructions de sécurité. Tout défaut de le faire pourrait entraîner des blessures graves.

Electrolux Home Products, Inc.
250 Bobby Jones Expressway
Augusta, GA 30907

 **The Electrolux Group.** *The world's No.1 choice.*
KITCHEN, CLEANING AND OUTDOOR APPLIANCES COMBINED

FRANÇAIS

IDENTIFICATION OF SYMBOLS



DANGER! This brushcutter can be dangerous! Careless or improper use can cause serious or even fatal injury.

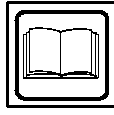

Read and understand the instruction manual before using the brushcutter.



Always wear appropriate ear protection, eye protection and head protection.

SAFETY RULES

WARNING: When using gardening appliances, basic safety precautions should always be followed to reduce the risk of fire and serious injury. Read and follow all instructions. Failure to do so can result in serious injury.



DANGER: This power tool can be dangerous! This unit can cause serious injury including amputation or blindness to the operator and others. The warnings and safety instructions in this manual must be followed to provide reasonable safety and efficiency in using the unit. The operator is responsible for following the warnings and instructions in this manual and on the unit. Read the entire instruction manual before assembling and using the unit! Restrict the use of this unit to persons who read, understand, and follow the warnings and instructions in this manual and on the unit. Never allow children to operate this unit.

WARNING: Blade can throw objects violently. You can be blinded or injured. Wear eye and leg protection.

ALWAYS WEAR:

-  Eye Protection
-  Leg Guards
-  Boots

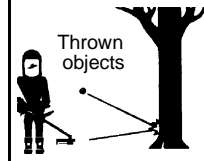

INSTRUCTION MANUAL



SAFETY INFORMATION ON THE UNIT

WARNING: Hazard zone for thrown objects. Blade can throw objects violently. Others can be blinded or injured. Keep people and animals 50 feet (15 meters) away.

DANGER: Never use flailing devices.

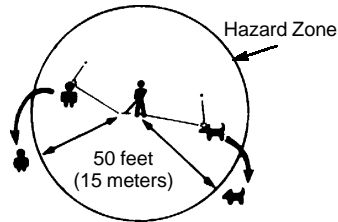
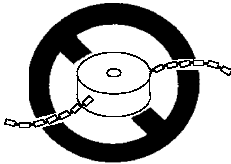

DANGER: Blade can thrust violently away from material it does not cut. Blade thrust can cause amputation of arms or legs. Keep people and animals 50 feet (15 meters) away.

WARNING: The blade continues to spin after throttle is released or engine is turned off. The coasting blade can throw objects or seriously cut you if accidentally touched. Stop the blade by contacting the left hand side of coasting blade with material already cut.

Stop coasting blade by contact with cut material.

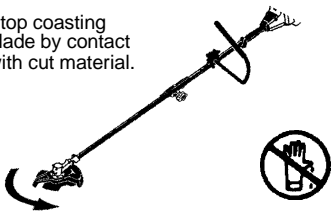

OPERATOR SAFETY

- Dress properly. Always wear safety glasses or similar eye protection when operating, or performing maintenance on your unit (safety glasses are available). Eye protection should be marked Z87.
- Always wear face or dust mask if operation is dusty.
- Always wear heavy, long pants, long sleeves, boots, and gloves. Wearing safety leg guards is recommended.
- Always wear foot protection. Do not go barefoot or wear sandals.
- Secure hair above shoulder length. Secure or remove loose clothing and jewelry or clothing with loosely hanging ties, straps, tassels, etc. They can be caught in moving parts.
- Being fully covered also helps protect you from debris and pieces of toxic plants thrown by spinning blade.
- Stay alert. Do not operate unit when you are tired, ill, upset or under influence of alcohol, drugs, or medication. Watch what you are doing; use common sense.
- Wear hearing protection.
- Never start or run the engine inside a closed room or building. Breathing exhaust fumes can kill.
- Keep handles free of oil and fuel.
- Always use the handlebar and a properly adjusted shoulder strap when using brush-cutter attachment (see ASSEMBLY).

UNIT/MAINTENANCE SAFETY

- **WARNING:** Disconnect powerhead spark plug (or disconnect powerhead from power source) before performing maintenance.
- Look for and replace damaged or loose parts before each use. Look for and repair fuel leaks before use. Keep unit in good working condition.
- Throw away blades that are bent, warped, cracked, broken, or damaged in any other way. Replace trimmer head parts that are cracked, chipped, broken, or damaged in any other way before using the unit.
- Maintain the unit according to recommended procedures. Keep the blade sharp. Never use flailing devices, wire, rope, string, etc.
- Use only specified blade; make sure it is properly installed and securely fastened.
- Never start engine with clutch shroud removed. The clutch can fly off and cause serious injury.
- Be sure blade stops turning when engine idles.

- Make carburetor adjustments with the lower end supported to prevent the blade from contacting any object. Hold the unit by hand; do not use the shoulder strap for support.
- Keep others away when making carburetor adjustments.
- Use only recommended Poulan/Weed Eater® accessories and replacement parts.
- Have all maintenance and service not explained in this manual performed by an authorized service dealer.

FUEL SAFETY

- Mix and pour fuel outdoors.
- Keep away from sparks or flames.
- Use a container approved for fuel.
- Do not smoke or allow smoking near fuel or the unit or while using the unit.
- Avoid spilling fuel or oil. Wipe up all fuel spills before starting engine.
- Move at least 10 feet (3 meters) away from fueling site before starting engine.
- Stop engine and allow it to cool before removing fuel cap.
- Remove fuel cap slowly.

CUTTING SAFETY

- **WARNING:** Inspect the area to be cut before each use. Remove objects (rocks, broken glass, nails, wire, string, etc.) which can be thrown or become entangled in the blade.
- Keep others including children, animals, bystanders, and helpers at least 50 feet (15 meters) away. Stop the engine immediately if you are approached.
- Always keep engine on the right-hand side of your body.
- Hold the unit firmly with both hands.
- Keep firm footing and balance. Do not over-reach.
- Keep blade below waist level.
- Do not raise powerhead engine above your waist.
- Keep all parts of your body away from blade and muffler.
- Cut from your left to your right. Cutting on the right side of the shield will throw debris away from the operator.
- Use only in daylight or good artificial light.
- Use only for jobs explained in this manual.

TRANSPORTING AND STORAGE

- Stop the powerhead engine before carrying unit.
 - Keep muffler away from your body.
 - Allow engine to cool and secure unit before storing or transporting it in a vehicle.
 - Empty the fuel tank before storing or transporting the unit. Use up fuel left in the carburetor by starting the engine and letting it run until it stops.
 - Store unit and fuel in an area where fuel vapors cannot reach sparks or open flames from water heaters, electric motors or switches, furnaces, etc.
 - Store unit so the blade cannot accidentally cause injury.
 - Store unit indoors, out of reach of children.
- If situations occur which are not covered in this manual, use care and good judgment. If you need assistance, call 1-800-554-6723.

SPECIAL NOTICE: Exposure to vibrations through prolonged use of gasoline powered hand tools could cause blood vessel or nerve damage in the fingers, hands, and joints of people prone to circulation disorders or abnormal swellings. Prolonged use in cold weather has been linked to blood vessel damage in otherwise healthy people. If symptoms occur such as numbness, pain, loss of strength, change in skin color or texture, or loss of feel-

ing in the fingers, hands, or joints, discontinue the use of this tool and seek medical attention. An anti-vibration system does not guarantee the avoidance of these problems. Users who operate power tools on a continual and regular basis must monitor closely their physical condition and the condition of this tool.

SAVE THESE INSTRUCTIONS

ASSEMBLY

CARTON CONTENTS

Check carton contents for the following:

- Brushcutter attachment
- Handlebar (with clamp and knob)
- Handlebar clamp base (with spacer tabs)
- Shoulder strap
- Upper shoulder strap clamp
- Lower shoulder strap clamp (with spacer tabs)
- Handlebar clamp screws (4)
- Shoulder strap clamp screws (2)
- Attachment hanger
- Hex wrench

WARNING: If received assembled, repeat all steps to ensure your unit is properly assembled and all fasteners are secure.

Examine parts for damage. Do not use damaged parts.

NOTE: If you need assistance or find that parts are missing or damaged, call 1-800-554-6723.

TOOLS REQUIRED

- Hex wrench (provided)

INSTALLING BRUSHCUTTER ATTACHMENT

CAUTION: When removing or installing attachments, place the unit on a flat surface for stability.

1. Loosen the coupler by turning the knob counterclockwise.

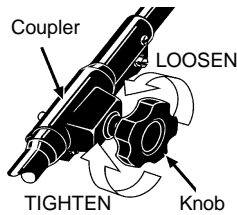

2. Remove the shaft cap from the brushcutter attachment (if present).
3. Position locking/release button of attachment into guide recess of coupler.
4. Push the attachment into the coupler until the locking/release button snaps into the primary hole.
5. Before using the unit, tighten the knob securely by turning clockwise.

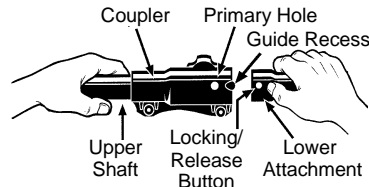

WARNING: Make sure the locking/release button is locked in the primary hole and the knob is securely tightened before operating the unit.

HANDLEBAR ASSEMBLY

DANGER: RISK OF CUT. To avoid serious injury, the barrier portion of the handlebar must be installed as shown on the upper shaft of the powerhead to provide a barrier between operator and the spinning blade. Attach shaft clamp above arrow on safety warning decal on the upper shaft (powerhead end of unit). Ensure handlebar is positioned on handlebar clamp between the arrows on the handlebar decal.

NOTE: The shaft clamp base has four spacer tabs attached. These tabs are provided to adapt this attachment for use with powerheads that have a 1" diameter upper shaft (the shaft clamp will not tighten down securely on the 1" diameter upper shaft without using these spacer tabs). The tabs must be broken off completely before use and placed over the screw holes on the clamp base. These tabs are not needed for powerheads with a 7/8" upper shaft.

HANDLEBAR CLAMP BASE

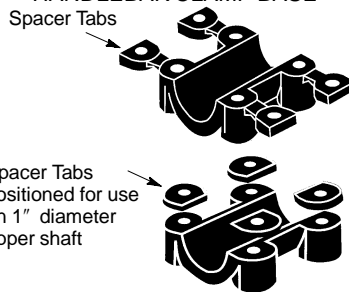

1. Place the shaft clamp over the upper shaft above the arrow on the safety decal.

- Position the clamp base under the upper shaft and align the shaft clamp and clamp base screw holes (use spacer tabs between shaft clamp and clamp base if necessary to secure clamp, i.e. for 1" diameter upper shaft).

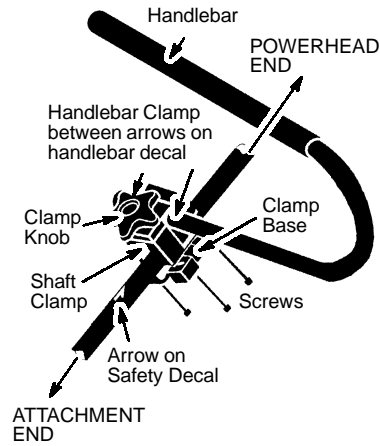

- Insert the four screws into the screw holes.
- Secure shaft clamp by tightening screws with the hex wrench.
- Position the handlebar as shown, ensuring the handlebar is positioned on the handlebar clamp between the arrows on the handlebar decal.
- Retighten handlebar by turning clamp knob clockwise until handlebar is secure and stationary in clamp (clamp knob cannot be overtightened).

SHOULDER STRAP ASSEMBLY

WARNING: Proper shoulder strap and handlebar adjustments must be made with the engine completely stopped before using unit. The shoulder strap clamp must be installed as shown above the handlebar on the upper shaft (powerhead end of unit).

NOTE: The lower shoulder strap clamp has two spacer tabs attached. These tabs are provided to adapt this attachment for use with powerheads that have a 1" (2.5 cm) diameter upper shaft (the shoulder strap clamp will not tighten down securely on the 1" (2.5 cm) diameter upper shaft without using these spacer tabs). The tabs must be broken off completely before use and placed over the screw holes on the lower shoulder strap clamp. These tabs are not needed for powerheads with a 7/8" (2.2 cm) upper shaft.

LOWER SHOULDER STRAP CLAMP

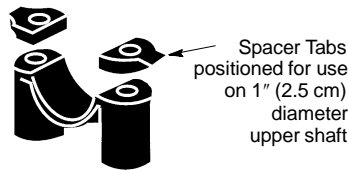
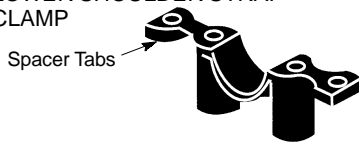

- Place the upper shoulder strap clamp over the upper shaft above the handlebar.
- Position the lower shoulder strap clamp under the upper shaft and align the upper and lower clamp screw holes (use spacer tabs between upper and lower clamps if necessary to secure clamp, i.e. for 1" (2.5 cm) diameter upper shaft).

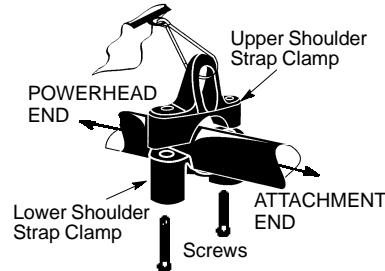

- Insert two screws into the screw holes.
- Secure shoulder strap clamp by tightening screws with the hex wrench.
- Insert your right arm and head through the shoulder strap and allow it to rest on your left shoulder. Make sure the danger sign is on your back and the hook is to the right side of your waist.
- NOTE:** A one-half twist is built in the shoulder strap to allow the strap to rest flat on the shoulder.
- Adjust the strap, allowing the hook to be about 6 inches below the waist.
- Fasten the strap hook to the clamp and lift the tool to the operating position.
- Try on shoulder strap and adjust for fit and balance before starting the engine or beginning a cutting operation.

NOTE: It may be necessary to relocate the shoulder strap clamp on the shaft for proper balancing of unit.

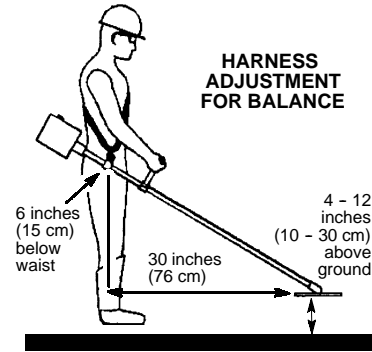

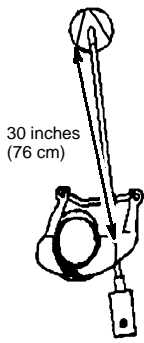

OPERATION

KNOW YOUR BRUSHCUTTER ATTACHMENT

READ THIS INSTRUCTION MANUAL AND SAFETY RULES BEFORE OPERATING YOUR BRUSHCUTTER ATTACHMENT. Compare the illustrations with your unit to familiarize yourself with the location of various controls and adjustments. Save this manual for future reference.

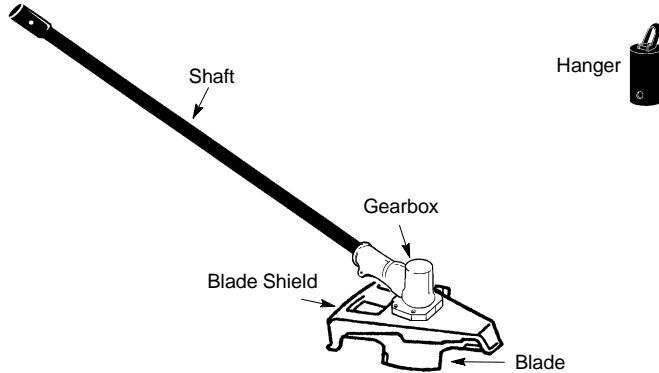

BLADE

The BLADE is designed for cutting grass, weeds, and brush up to 1/2 inch (1 cm) in diameter.

BLADE SHIELD

The BLADE SHIELD provides protection from the spinning blade.

WARNING: Always disconnect powerhead spark plug before removing or installing attachments.

REMOVING BRUSHCUTTER ATTACHMENT (OR OTHER OPTIONAL ATTACHMENTS)

CAUTION: When removing or installing attachments, place the powerhead and attachment on a flat surface for stability.

1. Loosen the coupler by turning the knob counterclockwise.

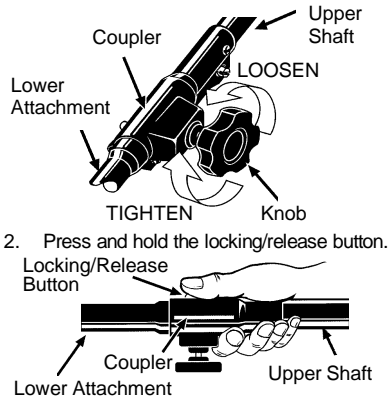

3. While securely holding the upper shaft, pull the attachment straight out of the coupler.

INSTALLING OPTIONAL ATTACHMENTS

1. Remove the shaft cap from the attachment (if present) and discard.
2. Position locking/release button of attachment into guide recess of upper shaft coupler.

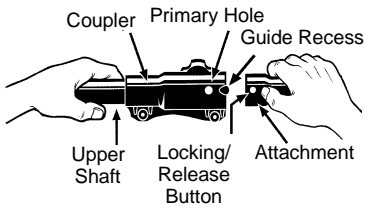

3. Push the attachment into the coupler until the locking/release button snaps into the primary hole.
4. Before using the unit, tighten the knob securely by turning clockwise.

INSTALLING ATTACHMENT HANGER

An attachment hanger is provided for storage when attachment is not in use. To install hanger on attachment:

1. Remove the shaft cap from the attachment (if present) and discard.
2. Press and hold the locking/release button.
3. Push hanger onto the attachment until the locking/release button snaps into the hole.

OPERATING POSITION

ALWAYS WEAR:

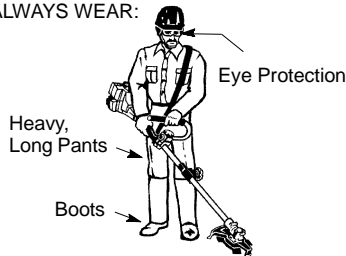

Cut from your left to your right.

NOTE: This brushcutter attachment is not designed for use with electric powerheads.

When operating unit with brushcutter attachment, clip shoulder strap onto upper shoulder strap clamp, stand as shown and check for the following:

- Wear eye protection and heavy clothing.
- Keep arms extended with right hand holding the trigger handle of powerhead.
- Keep left arm extended with left hand holding the handlebar.
- Keep unit below waist level.

- Shoulder strap pad should be centered on your left shoulder and danger sign centered on your back.
- Maintain full weight of tool on left shoulder.
- Without bending over, keep the blade near and parallel to the ground and not crowded into material being cut.

OPERATING INSTRUCTIONS FOR BRUSHCUTTER ATTACHMENT

• **Blade Thrust** is a reaction that only occurs when using a bladed unit. This reaction can cause serious injury such as amputation. Carefully study this section. It is important that you understand what causes blade thrust, how you can reduce the chance of its occurring, and how you can remain in control of unit if blade thrust occurs.

• **WHAT CAUSES BLADE THRUST - Blade Thrust** can occur when spinning blade contacts an object that it does not cut. This contact causes blade to stop for an instant and then suddenly move or "thrust" away from object that was hit. The "thrusting" reaction can be violent enough to cause operator to be propelled in any direction and lose control of unit. The uncontrolled unit can cause serious injury if blade contacts operator or others.

• **WHEN BLADE THRUST OCCURS - Blade Thrust** can occur without warning if the blade snags, stalls, or binds. This is more likely to occur in areas where it is difficult to see the material being cut. By using the unit properly, the occurrence of blade thrust will be reduced and the operator will be less likely to lose control.



- Cut only grass, weeds, and woody brush up to 1/2 inch (1 cm) in diameter with weed blade. Do not let blade contact material it cannot cut such as stumps, rocks, fences, metal, etc., or clusters of hard, woody brush with a diameter greater than 1/2 inch (1 cm).
- Use a sharp blade. A dull blade is more likely to snag and thrust.
- Cut only at full throttle. The blade will have maximum cutting power and is less likely to bind or stall.
- "Feed" the blade deliberately and not too rapidly. The blade can thrust away if it is fed too rapidly.
- Cut only from your left to your right. Cutting on right side of the shield will throw debris away from the operator.
- Use the shoulder strap and keep a firm grip on the unit with both hands. A properly adjusted shoulder strap will support the weight of the unit, freeing your arms and hands to control and guide the cutting motion.
- Keep feet comfortably spread apart and braced for a possible sudden, rapid thrust of unit. Do not overreach. Keep firm footing and balance.

- Keep blade below waist level. It will be easier to maintain control of unit.
- Do not raise the engine above your waist as the blade can come dangerously close to your body.
- Do not swing the unit with such force that you are in danger of losing your balance.

Bring the powerhead engine to cutting speed before entering the material to be cut.

If the blade does not turn when you squeeze the throttle trigger of the powerhead, make sure the attachment is fully inserted into the coupler.

Always release the throttle trigger and allow powerhead engine to return to idle speed when not cutting. The blade should not turn while the engine is running at idle. If the blade turns at idle, do not use your unit. Refer to the CARBURETOR ADJUSTMENT section of the powerhead manual or contact your authorized service dealer.

- Maintain good firm footing while using the unit. Do this by planting feet firmly in a comfortable apart position.
- Cut while swinging the upper part of your body from left to right.
- As you move forward to the next area to cut, be sure to maintain your balance, and footing.

RECOMMENDED CUTTING POSITION

Cut using the 2 o'clock to 4 o'clock position of the blade

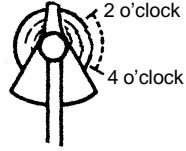

WARNING: The operator or others must not try to clear away cut material with the engine running or the blade turning to avoid serious injury. Stop engine and blade before removing materials wrapped around blade or shaft.

MAINTENANCE

WARNING: Always stop unit and disconnect spark plug wire before performing maintenance.

CHECK FOR DAMAGED OR WORN PARTS

Contact an authorized service dealer for replacement of damaged or worn parts.

- Blade Shield - Discontinue use of brushcutter attachment if shield is damaged.

CHECK FOR LOOSE FASTENERS AND PARTS

- Blade nut
- Fasteners

INSPECT AND CLEAN UNIT AND DECALS

- After each use, inspect complete unit for loose or damaged parts. Clean the unit and decals using a damp cloth with a mild detergent.
- Wipe off unit with a clean dry cloth.

BLADE MAINTENANCE

WARNING: The blade will continue to spin after the engine stops or after the throttle trigger has been released. To avoid serious injury, make sure the blade has stopped coasting and disconnect the spark plug before performing work on the blade.

WARNING: Always replace a blade that is bent, warped, cracked, broken, or damaged in any other way. Never attempt to straighten and reuse a damaged blade. Use only specified replacement blade. Wear protective gloves when handling or performing maintenance on the blade to help avoid injury.

- Check blade for flatness periodically. Lay the blade on a flat surface to inspect for flatness. Throw away a blade that is not flat.

SERVICE AND ADJUSTMENTS

BLADE REPLACEMENT

WARNING: The blade will continue to spin after the engine stops or after the throttle trigger has been released. To avoid serious injury, make sure the blade has stopped coasting and disconnect the spark plug before performing work on the blade.

WARNING: Wear protective gloves when handling or performing maintenance on the blade to avoid injury. The blade is sharp and can cut you even when it is not moving.

1. To remove the blade, align hole in the dust cup with the hole in the side of the gearbox by rotating the blade.
2. Insert a small screwdriver into aligned holes. This will keep the shaft from turning while loosening the blade nut.

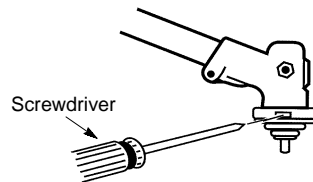

3. While holding the screwdriver in position, remove blade nut by turning clockwise as you are facing the nut.
4. Remove both washers and the blade from the blade shaft. Leave the dust cup on the gearbox.

5. Install new blade and retaining washer onto the threaded shaft extending from the gearbox (blade must be between the dust cup and the retaining washer). Make sure the raised part of the retaining washer is facing the gearbox, and the raised area fits into the hole in the center of the blade.

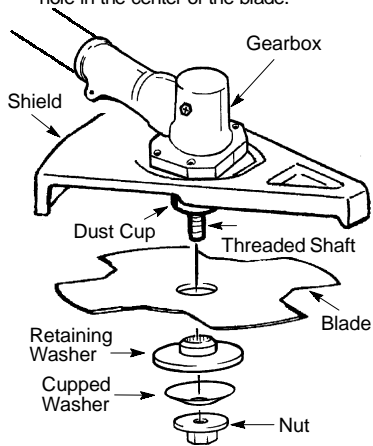

6. Place the cupped washer onto the shaft. Make sure the cupped side of the washer is toward the blade.
7. Install blade nut by threading onto the shaft counterclockwise as you are facing the nut.

NOTE: Make sure all parts are in place as illustrated, and the blade is sandwiched between the dust cup and the retaining washer. There should be no space between the blade and the dust cup or the retaining washer.

8. Tighten blade nut firmly with a wrench while holding screwdriver in position.
9. Remove the screwdriver.
10. Turn blade by hand. If the blade binds against the shield, or appears to be uneven, the blade is not centered, and you must reinstall.

STORAGE

WARNING: Perform the following steps after each use:

- Allow attachment and gearbox to cool before storing or transporting.
- Store attachment with blade shield in place. Position attachment so that any sharp object cannot accidentally cause injury.
- Store the attachment in a dry, well ventilated area out of the reach of children.

SEASONAL STORAGE

Prepare attachment for storage at end of season or if it will not be used for 30 days or more. If your brushcutter attachment is to be stored for a period of time:

- Clean the entire attachment.
- Inspect the blade shield area and clean any dirt, grass, leaves, or debris that has collected. Inspect the blade and blade shield; replace a blade that is bent, warped, cracked, broken or damaged in any other way.
- Lightly oil external metal surfaces.
- Apply a coating of oil to the entire surface of the blade; wrap it in heavy paper or cloth.
- Check entire attachment for loose screws or nuts. Replace any damaged, worn or broken parts.
- At the beginning of the next season, use only fresh fuel having the proper gasoline to oil ratio.

LIMITED WARRANTY

ELECTROLUX HOME PRODUCTS, INC., warrants to the original purchaser that each new gasoline tool or attachment is free from defects in material and workmanship and agrees to repair or replace under this warranty any defective gasoline product or attachment as follows from the original date of purchase.

2 YEARS - Parts and Labor, when used for household purposes.

90 DAYS - Parts and Labor, when used for commercial, professional, or income producing purposes.

30 DAYS - Parts and Labor, if used for rental purposes.

This warranty is not transferable and does not cover damage or liability caused by improper handling, improper maintenance, or the use of accessories and/or attachments not specifically recommended by **ELECTROLUX HOME PRODUCTS, INC.**, for this tool. Additionally, this warranty does not cover tune-ups, spark plugs, filters, cutting line, or rotating head parts that will wear and require replacement with reasonable use during the warranty period. This warranty does not cover pre-delivery setup or normal adjustments explained in the instruction manual.

THIS WARRANTY GIVES YOU SPECIFIC LEGAL RIGHTS, AND YOU MAY HAVE OTHER RIGHTS WHICH VARY FROM STATE TO STATE.

NO CLAIMS FOR CONSEQUENTIAL OR OTHER DAMAGES WILL BE ALLOWED, AND THERE ARE NO OTHER EXPRESS WARRANTIES EXCEPT THOSE EXPRESSLY STIPULATED HEREIN.

SOME STATES DO NOT ALLOW LIMITATIONS ON HOW LONG AN IMPLIED WARRANTY LASTS OR THE EXCLUSION OR LIMITATIONS OF INCIDENTAL OR CONSEQUENTIAL DAMAGES, SO THE ABOVE LIMITATIONS OR EXCLUSION MAY NOT APPLY TO YOU.

The policy of **ELECTROLUX HOME PRODUCTS, INC.**, is to continuously improve its products. Therefore, **ELECTROLUX HOME PRODUCTS, INC.**, reserves the right to change, modify, or discontinue models, designs, specifications, and accessories of all products at any time without notice or obligation to any purchaser.