

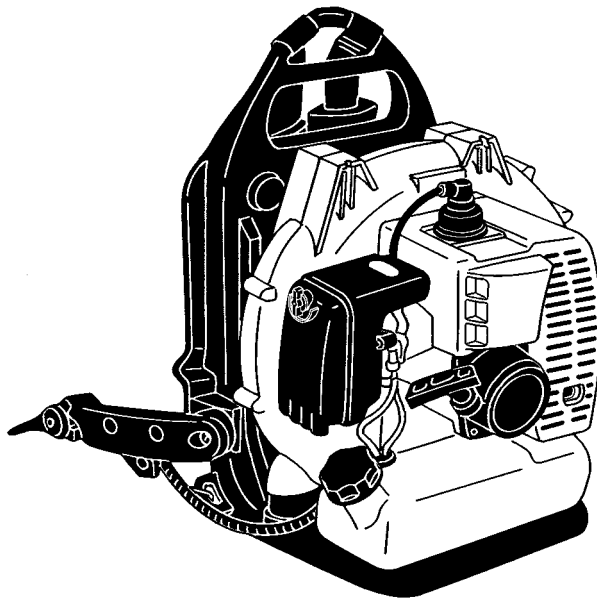

# OWNER/OPERATOR MANUAL

## BACKPACK BLOWER

# EB6200



### WARNING



The engine exhaust from this product contains chemicals known to the State of California to cause cancer, birth defects or other reproductive harm.

Thank you for purchasing a RedMax product.

Before using our blower, please read this manual carefully to understand the proper use of your unit.

Read this manual periodically.



**Read this manual carefully to understand all safety precautions, controls, proper operation and maintenance of your RedMax blower. Failure to do so could result in serious injury.**



## **SAFETY FIRST**

Instructions contained in warnings within this manual and warning seals marked with a  symbol on the blower concern critical points which must be taken into consideration to prevent possible serious bodily injury, and for this reason you are requested to read all such instructions carefully and follow them without fail.

Note that there may be times when warning seals peel off or become soiled and impossible to read. If this happens, you should contact the dealer from which you purchased the product to order new seals and affix the new seal(s) in the required location(s).

### **■ Notes on types of warnings**



Instructions labeled as shown at left, concern critical steps or procedures which must be followed in order to prevent accidents which could lead to serious bodily injury or death. This mark is used to indicate instructions which must be followed without exception.



Instructions labeled as shown at left concern steps or procedures which, if not followed correctly, could lead to mechanical failure, breakdown, or damage.



Used to label supplementary instructions designed to provide hints or directions useful in the use of the product.

# CONTENTS

<b>SAFETY PRECAUTIONS</b> .....	<b>2</b>
OPERATOR	
USE OF BLOWER	
WORKING CONDITION	
AVOID NOISE PROBLEM	
AVOID CHANCES OF DAMAGE	
<b>PARTS LOCATION &amp; SPECIFICATIONS</b> .....	<b>5</b>
<b>ASSEMBLY</b> .....	<b>5</b>
BLOWER TUBE	
<b>FUEL</b> .....	<b>6</b>
FUEL MIX	
MIXING FUEL	
FUELING	
<b>OPERATION</b> .....	<b>7</b>
CONTROL ARM	
STARTING ENGINE	
ADJUSTING IDLE SPEED	
STOPPING ENGINE	
<b>MAINTENANCE</b> .....	<b>8</b>
AIR CLEANER	
FUEL FILTER	
SPARK PLUG	
MUFFLER	
SPARK ARRESTER	
AIR INLET SCREEN	
SHOULDER STRAP	
<b>STORAGE</b> .....	<b>10</b>
<b>PARTS LIST</b> .....	<b>11</b>



## Safety Precautions

- Read this Blower Owner/Operator Manual carefully. Be sure you understand how to operate this unit properly before you use it. Failure to do so could result in serious injury.



- Be sure to keep this manual handy so that you may refer to it later whenever any questions arise. Also note that you are requested to contact the dealer from whom you purchased the product for assistance in the event that you have any questions which cannot be answered herein.
- Always be sure to include this manual when selling, lending, or otherwise transferring the ownership of this product.
- Please check and follow the local regulations.

### ■ OPERATOR

- Refrain from operating the blower if you are tired, ill, or upset, or if you are under the influence of alcohol, drugs or medication.



- Clothing attire should consist of long-sleeved shirt, long pants and proper protective equipment. Do not wear a necktie, scarf, muffler, or jewelry while using the blower.
- If you have long hair, tie it up and put it inside the head protection not to be inhaled.
- Always wear eye protection goggles.
- Always wear ear protectors to protect your ears from engine noise. If this guideline is not followed, hearing loss can occur.



- Wear a face mask to guard against the inhalation of dust.
- Wear anti-slip work gloves which can help

to grip the handle easier.

- Wear rubber-soled shoes or shoes with some other form of anti-slip protection to help protect you against falling.
- A person who is within a perimeter of 15m (50ft) should wear the same proper protective equipment as the user.

### ■ USE OF BLOWER

- Each time before starting the engine, inspect the entire unit to see if every part is in good order and is securely tightened in place. If any damage is found in the fuel line, the exhaust line, or the ignition wiring, do not use the blower until it has been repaired.
- Using the blower at top engine speed may cause excessive noise. Be cautious of the engine speed so not to cause a disturbance to those around you.

### IMPORTANT

- Before starting operation, always make sure to check if any obstacles are left inside the volute case. The obstacles may cause damage to the fan and the volute case, and also serious injury.

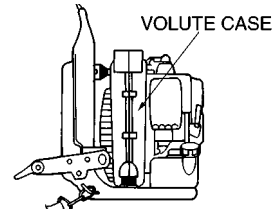

- Alert bystanders and neighbors to the beginning of the work.

### ▲ WARNING

Check to see if the shock-absorbing rubber mount has become cracked or otherwise damaged. **Note that failing to replace this rubber mount when it has become cracked or damaged may cause the engine to come loose from its frame during use, thus resulting in possible serious bodily injury.**

- If cracked, be sure to replace without delay.

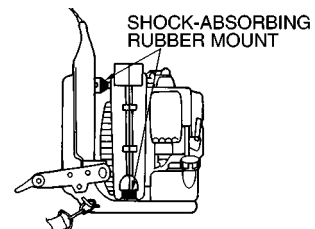



## Safety Precautions

Observe and understand these safety precautions strictly.  
Failure to do so could cause serious bodily injury or death.

### WARNING

- **Never use the blower without the screen for the air intake of the blower. Before each use, check that the screen is attached in place and is free from any damage.**

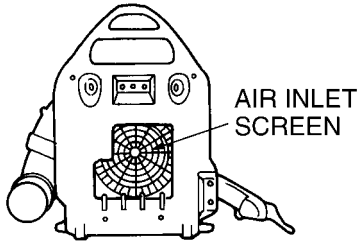

### WARNING

- **Never remove debris from the intake screen while the engine is running. Contact with rotating blower fan may result in a serious personal injury.**

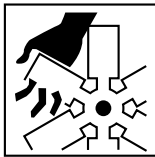

- Do not allow children to use blower. Make sure that each person you authorize to operate the blower understands all of the safety rules in this manual.
- Avoid using any accessory or attachment other than those bearing the RedMax mark for use with the blower.
- When suspending a job or inspecting the blower, be sure to stop engine.
- Drain the fuel from the fuel tank before transporting or storing the blower.
- When storing the blower, choose a space indoors free from moisture and out of the reach of children.
- Examine the blower at intervals for loose fasteners and rusted or damaged parts.
- Use special care **around the fuel line, the muffler, and the ignition wiring.**

- All engine service except for those described in this manual should be performed by competent service personnel. Improper service to the blower fan and muffler could cause a hazardous failure.
- Limit your working hours and take a break periodically.
- Have a periodic checkup for hearing.
- If you feel sick or fatigue, go see a doctor before operating any equipment.

### WORKING CONDITION

### WARNING

- Keep open flames and sparks away from the area where fuel is handled or stored, as the fuel is highly flammable.
- Make sure that the engine has cooled down before refueling.



- Mix and store fuel only in a approved container.
- Never smoke while refueling the blower.
- Wipe off any spilled fuel and tighten the fuel cap securely.
- Move at least 3m(10 ft) away from the fueling spot before starting the engine.
- Check the work area that the blower will be used in and remove or cover all valuables that may be damaged by the air blast or thrown debris.
- Avoid running the engine indoors. The exhaust gases contain harmful carbon monoxide.

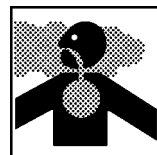



## Safety Precautions

- Keep operation area clear of all persons, particularly small children and pets. Injury may result from flying debris.
- Avoid using the blower where stable footing and balance are not assured.
- Never to touch the spark plug or plug cord while the engine is in operation. Doing so may result in being subjected to an electrical shock.



- Never to touch the muffler, spark plug, or other metallic parts and covers of the engine while the engine is in operation or right after shutting down the engine. These parts reach high temperatures during operation and doing so could result in serious burns.



### ■ AVOID NOISE PROBLEM

#### NOTE

**Check and follow the local regulations as to sound level and hours of operations for blower.**

- In general, operate blowers between 8a.m. and 5p.m. on week day and 9a.m. to 5p.m. weekends. Avoid using blower late at night and/or early in the morning.
- Loosen compacted leaves, grass or debris with a rake or broom beforehand, so that the lowest possible throttle setting would get the job done.
- In dusty conditions, slightly dampen surfaces or use mister attachment when water is available.
- Check if the air filter, air intakes and muffler are working properly.
- Never use more than one piece of the blower at a time.

### ■ AVOID CHANCES OF DAMAGE

- Avoid directing the blower nozzle toward persons, pets, cars, windows or anything that could be harmed by blowing debris or dust.
- Keep the nozzle at full extension when operating so as to make the air stream close to the ground.
- Collect any trash and leaves and put them into a proper container after the job is done.
- Always check to be sure that no debris has been blown onto someone else's property.

# Parts Location & Specifications

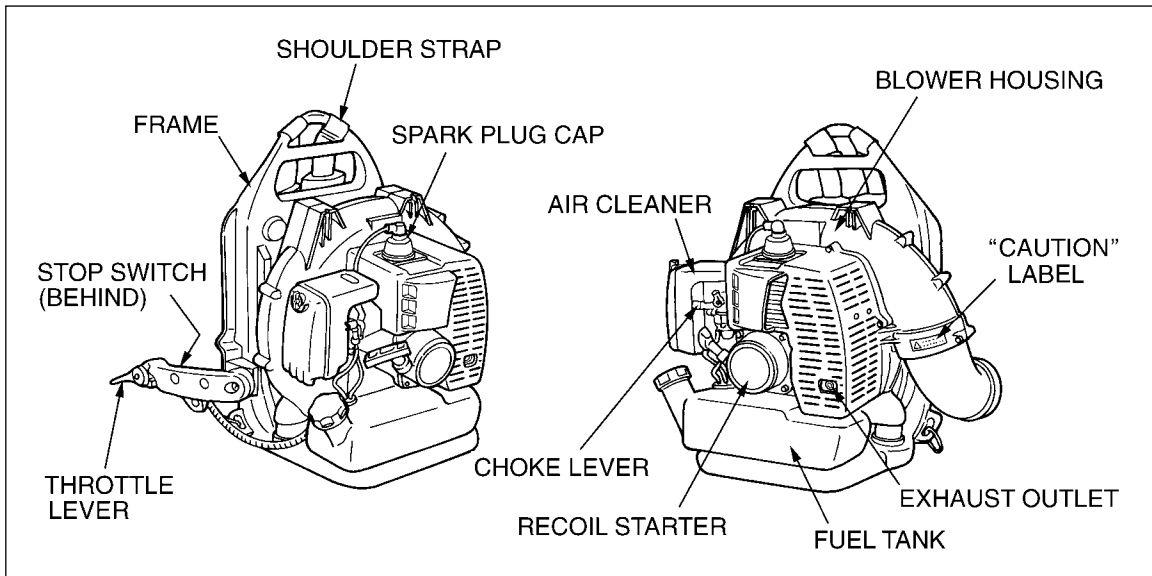

## MODEL EB6200

Dimensions ( L x W x H )	mm ( in )	480 x 530 x 490 (189 x 209 x 193)
Dry Weight	kg ( lbs )	8.6 (18.9)
Fuel Tank Capacity	liter ( fl. oz )	2.0 (67.6)
Engine Type		Air cooled 2-cycle gasoline engine
Piston Displacement	cc ( cu. in )	62 (3.78)
Air Filter		Regular size
Carburetor ( Diaphragm )	valve type	Rotary
Ignition System		C.D.I
Spark Plug		Champion RCJ6Y (Noise-proof)
Muffler		Spark arrester equipped
Operating Engine Speed	rpm	2000 to 7500
Fuel Consumption	liter/h ( fl. oz/h )	2.2 (65)
Air Volume (w/std Pipes)	cu. m/min ( cfm )	15 (529)
Air Volume (w/o Pipes)	cu. m/min ( cfm )	20 (730)
Air Velocity	m/sec ( mph )	90 (200)

## Assembly

### ■ BLOWER TUBES

1. Connect the blower and swivel joint with flexible hose. Clamp both ends of the flexible hose securely with the hardware supplied with the unit.
2. Align the protrusion and the groove provided on the tube ends and twist the tube until connection is locked up.

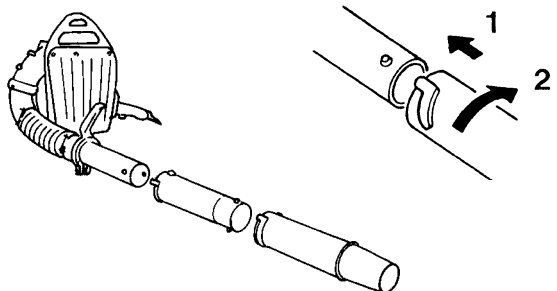

# Fuel

## ⚠ WARNING

- Gasoline is very flammable. Avoid smoking or bringing any flame or sparks near fuel. Make sure to stop the engine and allow it cool before refueling the unit. Select outdoor bare ground for fueling and move at least 3m(10ft) away from the fueling stop before starting the engine. Or it could lead to a fire.

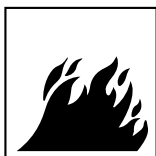

## ■ FUEL MIX

Follow the instructions below strictly. Or it could cause a mechanical failure.

- The engine is lubricated by oil mixed into gasoline. Prepare a mixture of unleaded, alcohol-free gasoline and RedMax oil or an anti-oxidant added quality oil expressly labeled for air-cooled 2-cycle engine use.

**Recommended mixing ratio is 32 : 1  
or 50 : 1 with RedMax JASO/ISO Oil.**

- Do not mix fuels which have been left unused for a period of one month or more.

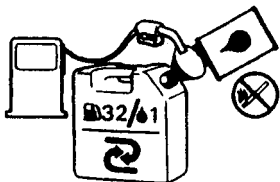

- Make sure to use gasoline with a minimum octane number of 90 ROZ(USA/Canada : pump octane min.87)
- Unleaded gasoline is recommended to reduce the contamination of the air for the sake of your healths and the environment.
- Disqualified gasolines or oils may damage sealing rings, fuel lines or fuel tank of the engine.
- **Exhaust emission are controlled by the fundamental engine parameters and components (eq., carburetion, ignition timing and port timing) without addition**

of any major hardware or the introduction of an inert material during combustion.

## 32:1 MIXING CHART

GASOLINE	gal.	1	2	3	4	5
2-CYCLE OIL	fl.oz	4	8	12	16	20

- **These engines are certified to operate on unleaded gasoline.**

## ■ MIXING FUEL

1. Measure out the quantities of gasoline and oil to be mixed.
2. Put some of the gasoline into a clean, marked fuel container.
3. Pour in all of the oil, cap the container and shake it well.
4. Pour in the rest of gasoline and shake again for one minute.
5. Indicate the contents on outside of container to prevent with other containers.

## DO NOT USE :

- **Fuel containing no oil (raw gasoline)** may cause the engine becoming overheated and damaged.
- **Gasohol** may cause deterioration of rubber and plastic parts and disruption of the engine lubrication.
- **Oil for 4-cycle engine use or water-cooled 2-cycle engine use** may cause spark plug fouling, carbon building-up and piston ring sticking.
- **Mixed fuels which have been left unused for a period of one month or more** may have the carburetor clogged or result in the engine failing to operate properly.

## ■ FUELING

1. Unfasten and remove the fuel cap. Put the cap on a clean surface for dirt prevention.
2. Pour fuel into the fuel tank up to 80% of full capacity.
3. Replace the fuel cap and tighten securely. Spilled fuel must be wiped away from the blower before starting the engine.



# Operation

## ■ CONTROL ARM

1. Hold the upper end of the control arm in hand and, while pulling it away from the unit, rotate arm forward (anti-clockwise as the arrow direction) until it clicks. To fold the arm, reverse the order.

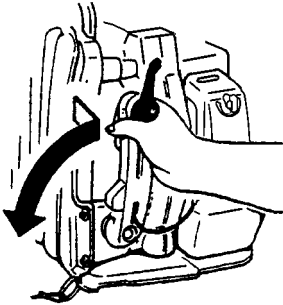

## ■ STARTING ENGINE

### IMPORTANT

- Avoid operating the blower with the flexible tube and swivel joint disconnected. That will reduce the cooling air and the engine could be damaged by overheating.

1. Push the primer bulb until fuel flows out in the clear tube.
2. When the engine is cool, close the choke.

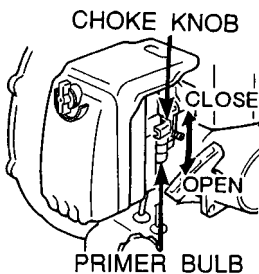

3. Set the throttle lever in 1/3 open position.

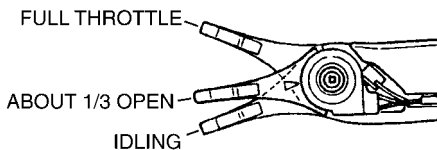

4. To start, hold the top of the blower firmly with your left hand. Pull the starter knob slowly until you feel it engage and then give it a vigorous strong pull.

### IMPORTANT

- Avoid pulling the starter rope out to its full extension. Do not allow the starter rope to snap back. Rewind the rope slowly. This will prevent premature damage to the starter.
- Do not let a person stand near the blower or the exhaust port.

5. Once the engine is running, gradually open the choke if it was set closed, and let the engine run at idle speed for a minute to warm it up.

### NOTE

- When the engine fails to start after several attempts due to overchoking, open the choke and repeat pulling the rope.

## ■ ADJUSTING IDLE SPEED

- The idling speed is set for 2000 rpm at the factory. If it is necessary to adjust the idle speed, use the adjustment screw on the top side of carburetor.

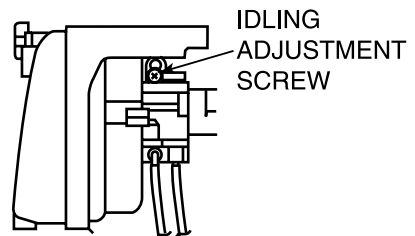

## ■ STOPPING ENGINE

- Move the throttle lever to the idling position and press the stop switch (red button) until the engine comes to a complete stop.

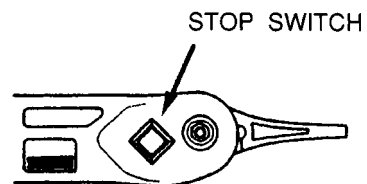

# Maintenance

## ⚠ WARNING

- Make sure that the engine has stopped and is cool before performing any service to the blower. Contact with rotating blower fan or hot muffler may result in a personal injury.

## ■ AIR CLEANER

- Never operate the blower without an air filter or with a deformed or broken filter element.
- Check the air cleaner every 25 hours of use or more frequently if used under dusty conditions. A clogged air filter may increase fuel consumption while cutting down the engine power. Never operate the blower without the air filter or with a deformed filter element because unfiltered dusty air will quickly ruin the engine.

### CLEANING AIR FILTER:

1. Remove the air cleaner cover by pulling the tab on bottom and take out the filter element.

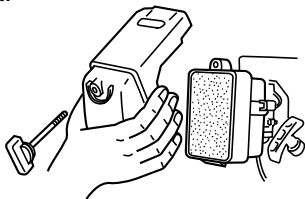

2. Use neutral detergent and warm water to clean the filter element. After cleaning, air dry the element completely and moisten with a small amount of motor oil.

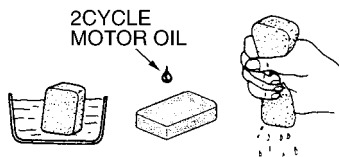

3. Place the filter element into the air cleaner housing and press the cover against the housing until it clicks. Never forget to attach the screen. If the screen is not attached, the cleaner will not seal properly and the dusts come into the cylinder.

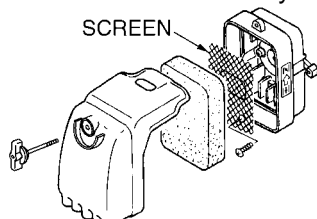

## ■ FUEL FILTER

- A clogged fuel filter may cause poor acceleration of the engine. Check periodically to see if the filter is clogged with dirt. The filter can be taken out of the fueling port using a small wire hook. Disconnect the filter assembly from the fuel pipe and unhook the retainer to disassemble it. Clean the components with gasoline.

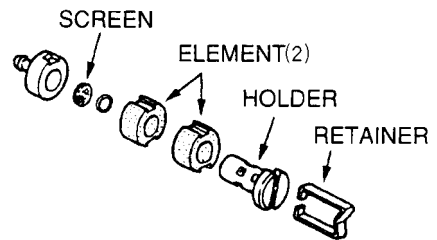

## ■ SPARK PLUG

- The spark plug may gather carbon deposits on its firing end with reasonable use. Remove and inspect the spark plug every 25 hours and clean the electrodes as necessary with a wire brush. The spark gap should be adjusted to .025 in.

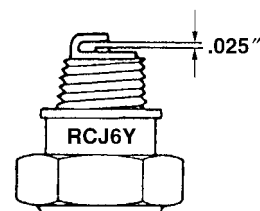

- Plug manufacturers recommend replacing the plug twice a year to avoid unexpected plug failure in a job.

## REPLACEMENT PLUG IS A CHAMPION RCJ6Y

## IMPORTANT

- Note that using any spark plugs other than those designated may result in the engine failing to operate properly or in the engine becoming overheated and damaged.
- To install the spark plug, first turn the plug until it is finger tight, then tighten it a quarter turn more with a socket wrench.

# Maintenance

## ■ MUFFLER

Pay close attention to the precautions below. Or it could cause an accident or a fire.

### **▲ WARNING**

- Inspect periodically, the muffler for loose fasteners, any damage or corrosion. If any sign of exhaust leakage is found, do not use the blower and have it repaired immediately.
- **Note that failing to do so may result in the engine catching on fire.**

### **IMPORTANT**

- Before starting operation, always make sure to check if the muffler is properly held by three bolts to the cylinder. (Fastening Torque : 80~120kg-cm)
- Even if one bolt out of three bolts is loose, the muffler may get loose during operation which may result in engine catching on fire.

## ■ SPARK ARRESTER

- The muffler is equipped with a spark arrester to prevent red hot carbon from flying out of the exhaust outlet. Periodically inspect and clean as necessary with a wire brush. In the State of California it is required by law (Section 4442 of the California Public Resources Code) to equip a spark arrester when a gas powered tool is used in any forest covered, brush covered, or grass covered unimproved land.

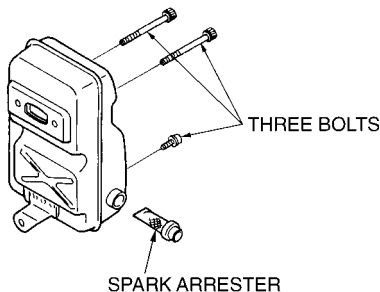

## ■ AIR INLET SCREEN

### **IMPORTANT**

- Before operating the blower, check that the air inlet screen is attached in place, is free from any damage and is not clogged with dusts or obstacles.

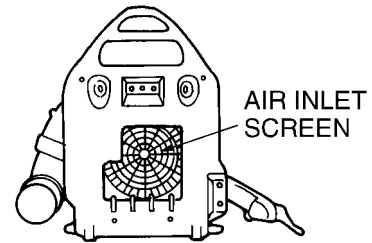

- Blowing air is taken in from the air inlet screen. When air flow has dropped down during operation, stop the engine and inspect the air inlet screen for blocking by obstacles.
- Note that failure to remove any such obstacles may result in the engine becoming overheated and damaged.

### **▲ WARNING**

- **Never use the blower without the air inlet screen. Before inspecting the screen, stop the engine without fail. Contact with rotating blower fan may result in a serious personal injury.**

# Maintenance

---

## ■ SHOULDER STRAP

- If the shoulder strap is damaged it may break during use, thus causing the product to fall and resulting in personal injury. Follow the instructions below to replace the shoulder strap.
- Pass the top end of the strap through the hanger, making the **FLAPPED SIDE OUTSIDE**.
- Pull the end of the strap through the ring, on the strap, and then push the ring towards the hanger as close as possible.

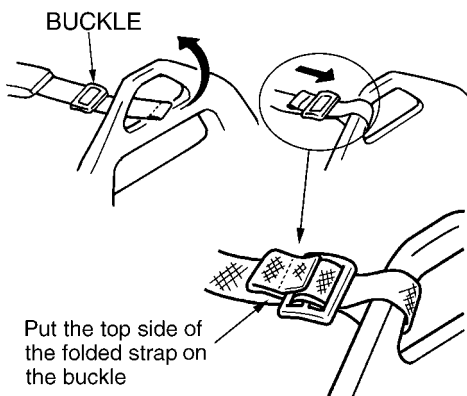

## **⚠ WARNING**

- **The flap on the end of the strap works as a stopper. Never install the strap with the flapped side inside, or the unit may fall from the operator, which could result in injury to the operator and/or damage to the unit.**

## **NOTE**

- **Never use a blower which is not properly repaired or remodeled.**

# Storage

---

## **BEFORE STORING THE BLOWER:**

1. Drain a fuel tank and push the primer bulb until it becomes empty of fuel.
2. Remove the spark plug and drop a spoonful of 2-cycle oil into the cylinder. Crank the engine several time and replace the plug.

### **BACKPACK BLOWER**

# **EB6200**

**NOTE :**

1. Use KOMATSU ZENOAH genuine parts as specified in the parts list for repair and/or replacement.
2. KOMATSU ZENOAH does not warrant the machines, which have been damaged by the use of any parts other than those specified by the company.
3. When placing parts orders for repair and/or replacement, check if the model name and the serial number are applicable to those specified in the parts list, then use parts number described in the parts list.
4. The contents described in the parts list may change due to improvement.
5. The parts for the machine shall be supplied seven (7) years after the machine is discontinued. [It is possible that some specific parts may be subject to change of their delivery term and list price within the limit of ten (7) years after the machine is discontinued. It is also possible that some parts may be available even after the limit of seven (7) years.]

# Parts List : EB6200

## Fig.1 CARBURETOR COMPONENTS

Carburetor Ass'y P/NO. 2750-81000

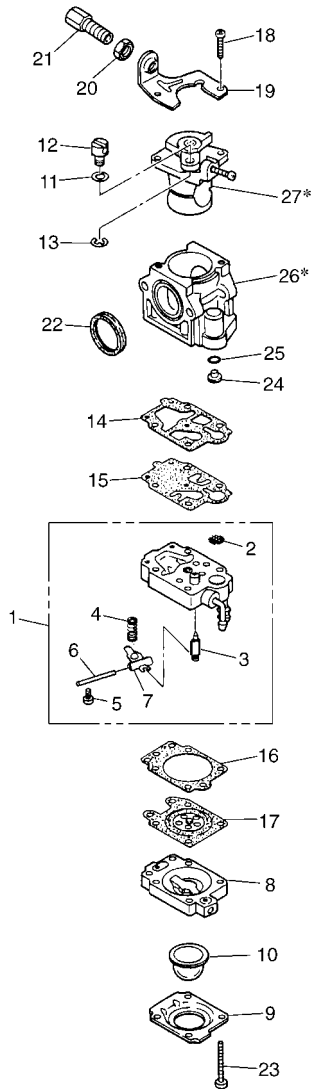

# EB6200

## Fig.1 CARBURETOR COMPONENTS

Key#	Part Number	Description	Q'ty	Key#	Part Number	Description	Q'ty
1	1850-81450	Body ass'y	1				
2	3306-81380	Screen	1				
3	3356-81310	Valve	1				
4	1850-81270	Spring	1				
5	1850-81220	Screw	1				
6	3310-81250	Pin	1				
7	3310-81230	Lever	1				
8	1850-81490	Body	1				
9	1850-81520	Cover	1				
10	1751-81510	Pump	1				
11	5500-81160	Washer	1				
12	1881-81140	Swivel	1				
13	1751-81130	Ring	1				
14	1065-81410	Gasket	1				
15	1065-81420	Diaphragm	1				
16	1850-81470	Gasket	1				
17	3310-81260	Diaphragm	1				
18	1752-81110	Screw	2				
19	5500-81120	Bracket	1				
20	1751-81180	Nut	1				
21	1918-81170	Screw	1				
22	1881-81130	Ring	1				
23	1850-81530	Screw	4				
24	2750-81250	Jet	1				
25	1751-81240	O-Ring	1				
26*	_____	Body	1				
27*	_____	Valve ass'y	1				
<p>[NOTE]</p> <ul style="list-style-type: none"> <li>• 26*-Body and 27*-Valve ass'y are not supplied as an individual part respectively, but supplied as a carburetor ass'y (P/NO. 2750-81000).</li> </ul>							

# Parts List : EB6200

## Fig.2 ENGINE GROUP

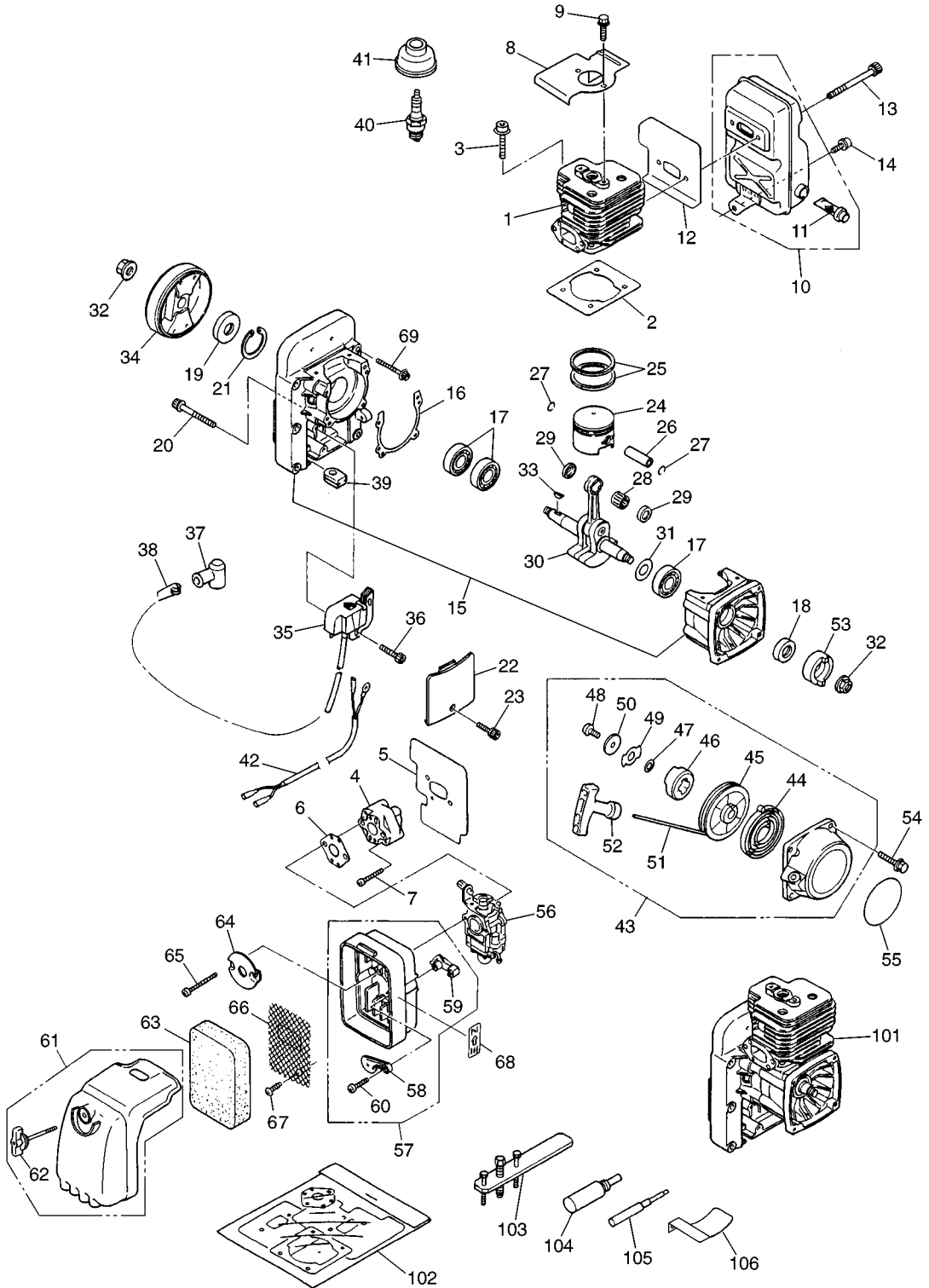



# EB6200

## Fig.2 ENGINE GROUP

Key#	Part Number	Description	Q'ty	Key#	Part Number	Description	Q'ty
1	2750-12110	Cylinder	1	46	1487-75140	Dog	1
2	2750-12210	Gasket, base	1	47	1861-75150	Washer	1
3	2750-12130	Bolt	4	48	1483-75270	Screw	1
4	1484-13160	Insulator	1	49	1487-75160	Retainer	1
5	2750-13130	Gasket	1	50	1487-75170	Washer	1
6	1460-13132	Gasket	1	51	1400-75160	Rope	1
7	0263-90535	Screw	2	52	1400-75170	Knob	1
8	2750-12510	Cover	1	53	1487-75211	Pulley	1
9	2750-12520	Bolt	2	54	3460-75510	Bolt	4
10	2756-15100	Muffler ass'y	1	55	2750-75611	Label	1
11	1421-15120	Arrester	1	56	2750-81000	Carburetor	1
12	2750-15210	Gasket	1	57	3407-82102	Body ass'y	1
13	2750-15160	Bolt	2	58	3407-82130	Plate	1
14	2750-15170	Bolt	1	59	3407-82140	Lever	1
15	2750-21100	Crankcase comp	1	60	2630-33610	Screw	1
16	2750-21140	Gasket	1	61	1487-82200	Cover ass'y	1
17	2810-21240	Bearing	3	62	1487-82210	Knob	1
18	1520-21220	Oil seal	1	63	1491-82311	Element	1
19	1400-21220	Oil seal	1	64	1484-82510	Plate	1
20	01252-30530	Bolt	4	65	0263-90560	Screw	2
21	04065-03515	Snap ring	1	66	1491-82352	Screen	1
22	2750-21210	Cover	1	67	1491-82360	Screw	1
23	1565-72211	Bolt	1	68	1133-82060	Label	1
24	2750-41110	Piston	1	69	2750-21510	Bolt	6
25	3366-41210	Ring	2	101	2750-05011	Short block	OP
26	3366-41310	Piston pin	1	102	2750-06010	Gasket kit	OP
27	3350-41320	Snap ring	2	103	2750-96100	Puller ass'y	OP
28	1400-41410	Bearing	1	104	3350-96220	Stopper	OP
29	2616-41510	Washer	2	105	2750-96230	Guide	OP
30	2750-42000	Crankshaft comp	1	106	2750-96240	Gauge	OP
31	1300-42410	Shim	0~1				
32	1400-43230	Nut	2				
33	1000-43240	Key	1				
34	2750-71110	Rotor	1				
35	2750-71200	Coil ass'y	1				
36	2750-72150	Bolt	2				
37	1900-72111	Cap	1				
38	1900-72120	Spring	1				
39	5500-72130	Grommet	1				
40	5602-73110	Spark plug (Champion RCJ6Y)	1				
41	2751-71220	Cap	1				
42	2750-73200	Cord comp	1				
43	1487-75100	Recoil ass'y	1				
44	1180-75221	Spring	1				
45	1487-75120	Reel	1				

# Parts List : EB6200

## Fig.3 BLOWER GROUP

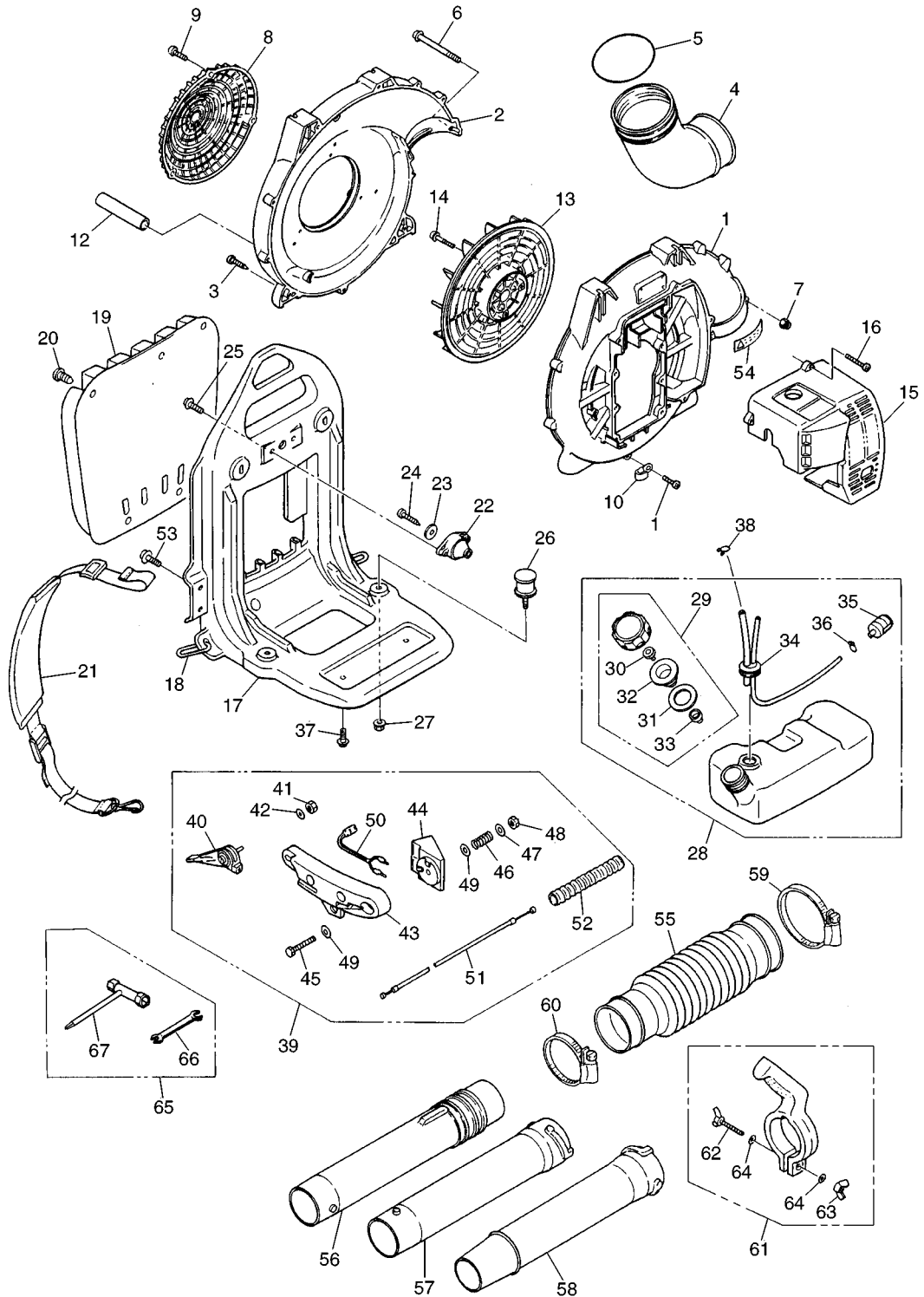

# EB6200

## Fig.3 BLOWER GROUP

Key#	Part Number	Description	Q'ty	Key#	Part Number	Description	Q'ty
1	2750-31110	Volute case	1	47	3495-25440	Washer	1
2	2750-31210	Volute cover	1	48	01584-00605	Nut	1
3	2750-31150	Screw	9	49	3495-25450	Washer	2
4	3490-11150	Elbow	1	50	3495-25510	Switch	1
5	07000-02095	O-Ring	1	51	3407-83110	Cable comp	1
6	2750-31420	Screw	2	52	3495-25810	Tube	1
7	3310-53331	Nut	2	53	2750-32540	Bolt	2
8	2750-31310	Cover Inlet	1	54	2750-31910	Label	1
9	2750-31150	Screw	3	55	2750-51110	Hose	1
10	1140-72231	Clamp	1	56	2750-51200	Swivel joint	1
11	3407-16120	Screw	1	57	6811-51210	Pipe, straight	1
12	2750-31290	Tube	1	58	6811-51220	Pipe, end	1
13	2750-31510	Fan	1	59	2756-51510	Clamp	1
14	3407-12210	Bolt	4	60	2756-51520	Clamp	1
15	2750-31612	Engine cover	1	61	2750-51500	Grip ass'y	1
16	2750-31150	Screw	4	62	3495-51420	Wing bolt	1
17	2756-32100	Frame comp	1	63	3495-51430	Wing nut	1
18	3490-21120	Ring	2	64	3238-15230	Washer	2
19	3460-21311	Pad	1	65	2750-91000	Tool set	1
20	3495-21320	Clip	4	66	3540-91120	Spanner	1
21	2756-32300	Band ass'y	2	67	2750-91130	Socket	1
22	2750-32510	Damper, upper	1				
23	2750-32520	Washer	1				
24	2750-32530	Screw	1				
25	2750-32540	Bolt	2				
26	2750-32610	Damper, lower	2				
27	2750-32620	Nut	2				
28	2756-85100	Tank ass'y	1				
29	4550-85200	Cap ass'y	1				
30	5600-85250	Valve	1				
31	4500-85220	Packing	1				
32	4500-85230	Holder	1				
33	5600-85240	Cap	1				
34	2750-85300	Pipe comp	1				
35	3302-85400	Filter	1				
36	1260-85460	Clip	1				
37	3407-23610	Screw	2				
38	1100-86120	Clip	1				
39	3407-25000	Lever set	1				
40	3495-25110	Lever	1				
41	3310-53331	Nut	1				
42	01642-20508	Washer	1				
43	3495-25212	Arm	1				
44	3495-25310	Bracket	1				
45	3495-25410	Bolt	1				
46	3495-25420	Spring	1				

**CALIFORNIA EMISSION CONTROL WARRANTY STATEMENT**  
**YOUR WARRANTY RIGHTS AND OBLIGATIONS**

**THE CALIFORNIA AIR RESOURCES BOARD** AND KOMATSU ZENOAH Co. ARE PLEASED TO EXPLAIN THE **EMISSION CONTROL SYSTEM WARRANTY** ON YOUR **1995 AND LATER** LAWN AND GARDEN EQUIPMENT ENGINE. IN CALIFORNIA, NEW UTILITY AND LAWN AND GARDEN EQUIPMENT ENGINES MUST BE DESIGNED, BUILT AND EQUIPPED TO MEET THE STATE'S STRINGENT ANTI-SMOG STANDARDS.

KOMATSU ZENOAH Co, MUST WARRANT THE EMISSION CONTROL SYSTEM ON YOUR LAWN AND GARDEN EQUIPMENT ENGINE FOR THE PERIODS OF TIME LISTED BELOW PROVIDED THERE HAS BEEN NO ABUSE, NEGLIGENCE OR IMPROPER MAINTENANCE OF YOUR LAWN AND GARDEN EQUIPMENT ENGINE.

YOUR EMISSION CONTROL SYSTEM. MAY INCLUDE PARTS SUCH AS THE CARBURETOR, THE IGNITION SYSTEM, AND CATALYTIC CONVERTER. ALSO INCLUDED MAY BE THE HOSES, BELTS, CONNECTORS AND OTHER EMISSION-RELATED ASSEMBLIES.

WHERE A WARRANTABLE CONDITION EXISTS, KOMATSU ZENOAH Co. WILL REPAIR YOUR LAWN AND GARDEN EQUIPMENT ENGINE AT NO COST TO YOU INCLUDING DIAGNOSIS, PARTS AND LABOR.

**MANUFACTURER'S WARRANTY COVERAGE:**

THE 1995 AND LATER UTILITY AND LAWN AND GARDEN EQUIPMENT ENGINES ARE WARRANTED FOR **TWO YEARS**. IF ANY EMISSION-RELATED PART ON YOUR ENGINE IS DEFECTIVE, THE PART WILL BE REPAIRED OR REPLACED BY KOMATSU ZENOAH Co.

**OWNER'S WARRANTY RESPONSIBILITIES:**

- AS THE LAWN AND GARDEN EQUIPMENT ENGINE OWNER, YOU ARE RESPONSIBLE FOR THE PERFORMANCE OF THE **REQUIRED MAINTENANCE LISTED IN YOUR OWNER'S MANUAL**. KOMATSU ZENOAH Co. RECOMMENDS THAT YOU RETAIN ALL RECEIPTS COVERING MAINTENANCE ON YOUR LAWN AND GARDEN ENGINE, BUT KOMATSU ZENOAH Co. CAN NOT DENY WARRANTY SOLELY FOR THE LACK OF RECEIPTS OR FOR YOUR FAILURE TO ENSURE THE PERFORMANCE OF ALL SCHEDULED MAINTENANCE.
  
- AS THE LAWN AND GARDEN EQUIPMENT ENGINE OWNER, YOU SHOULD BE AWARE, HOWEVER, THAT KOMATSU ZENOAH Co. MAY DENY YOU WARRANTY COVERAGE IF YOUR LAWN AND GARDEN EQUIPMENT ENGINE OR A PART HAS FAILED DUE TO ABUSE, NEGLIGENCE, IMPROPER MAINTENANCE OR UNAPPROVED MODIFICATION.
  
- YOU ARE RESPONSIBLE FOR PRESENTING YOUR LAWN AND GARDEN EQUIPMENT ENGINE TO A KOMATSU ZENOAH Co. DISTRIBUTION CENTER AS SOON AS A PROBLEM EXISTS. THE WARRANTY REPAIRS SHOULD BE COMPLETED IN A REASONABLE AMOUNT OF TIME, NOT TO EXCEED **30 DAYS**.

IF YOU HAVE ANY QUESTIONS REGARDING YOU WARRANTY RIGHTS AND RESPONSIBILITIES, YOU SHOULD CONTACT KOMATSU ZENOAH AMERICA INC. AT (770)-381-5147.

**RedMax BLOWERS**  
**MODEL EB6200**  
**2-YEAR LIMITED WARRANTY**

**EMISSION-RELATED PARTS**, FOR TWO (2) YEARS FROM THE DATE OF ORIGINAL DELIVERY OF THE MODEL EB6200 UNIT, KOMATSU ZENOAH AMERICA INC. (THE COMPANY), THROUGH ANY RedMax DEALER, WILL REPAIR OR REPLACE, FREE OF CHARGE, FOR THE ORIGINAL AND EACH SUBSEQUENT PURCHASER, ANY PART OR PARTS FOUND TO BE DEFECTIVE IN MATERIAL AND/OR WORKMANSHIP. EMISSION-RELATED PARTS ARE:

**THE CARBURETOR ASSY, COIL ASSY, ROTOR, SPARK PLUG,  
AIR FILTER, FUEL FILTER, INTAKE MANIFOLD, AND THE GASKETS**

**ALL OTHER PARTS EXCEPT ABOVE PARTS**, FOR TWO (2) YEARS OF HOME USE [ ONE (1) YEAR FOR ANY OTHER USE ] FROM THE DATE OF ORIGINAL ANY DELIVERY OF THE MODEL EB6200 UNIT, THE COMPANY, THROUGH ANY RedMax DEALER, WILL REPAIR OR REPLACE, FREE OF CHARGE, FOR THE ORIGINAL PUSHCHASER, ANY PART OR PARTS FOUND TO BE DEFECTIVE IN MATERIAL AND/OR WORKMANSHIP. **THIS IS THE EXCLUSIVE REMEDY.**

THE PURCHASER SHALL BEAR COSTS OF TRANSPORTING THE UNIT TO AND FROM THE RedMax DEALER.

THE PURCHASER SHALL NOT BE CHARGED FOR DIAGNOSTIC LABOR WHICH LEADS TO THE DETERMINATION THAT A WARRANTED PART IS DEFECTIVE, IF THE DIAGNOSTIC WORK IS PERFORMED AT THE RedMax DEALER.

THE PURCHASER OR OWNER IS RESPONSIBLE FOR THE PERFORMANCE OF THE REQUIRED MAINTENANCE AS DEFINED BY THE MANUFACTURER IN THE OWNER/OPERATOR MANUAL.

ANY WARRANTED PART WHICH IS NOT SCHEDULED FOR REPLACEMENT AS REQUIRED MAINTENANCE, OR WHICH IS SCHEDULED ONLY FOR REGULAR INSPECTION TO THE EFFECT OF "REPAIR OR REPLACE AS NECESSARY" SHALL BE WARRANTED FOR THE WARRANTY PERIOD. ANY WARRANTED PART WHICH IS SCHEDULED FOR REPLACEMENT AS REQUIRED MAINTENANCE SHALL BE WARRANTED FOR THE PERIOD OF TIME UP TO THE FIRST SCHEDULED REPLACEMENT POINT FOR THAT PART.

ANY REPLACEMENT PART THAT IS EQUIVALENT IN PERFORMANCE AND DURABILITY MAY BE USED IN NON-WARRANTY MAINTENANCE OR REPAIRS, AND SHALL NOT REDUCE THE WARRANTY OBLIGATION OF THE COMPANY.

THE COMPANY IS LIABLE FOR DAMAGES TO OTHER ENGINE COMPONENTS CAUSED BY THE FAILURE OF A WARRANTED PARTS STILL UNDER WARRANTY.

**THIS WARRANTY DOES NOT APPLY TO** THOSE UNITS WHICH HAVE BEEN DAMAGED BY NEGLIGENCE OF INSTRUCTION LISTED IN THE OWNER/OPERATOR MANUAL FOR PROPER USE AND MAINTENANCE OF THE UNITS, ACCIDENT MISHANDLING, ALTERATION, ABUSE, IMPROPER LUBRICATION. USE OF ANY PARTS OR ACCESSORIES OTHER THAN THOSE SPECIFIED BY THE COMPANY, OR OTHER CAUSES BEYOND THE COMPANY'S CONTROL.

**THIS WARRANTY DOES NOT COVER** THOSE PARTS REPLACED BY NORMAL WEAR OR HARMLESS CHANGES IN THEIR APPEARANCE.

**THERE ARE NO OTHER EXPRESS WARRANTIES.**

**IMPLIED WARRANTIES** INCLUDING THOSE OF MERCHANTABILITY AND FITNESS FOR A PARTICULAR PURPOSE **ARE LIMITED TO TWO (2) YEARS OF HOME USE [ONE (1) YEAR FOR ANY OTHER USE]** FROM THE ORIGINAL DELIVERY DATE.

**LIABILITIES FOR INCIDENTAL OR CONSEQUENTIAL DAMAGE UNDER ANY AND ALL WARRANTIES ARE EXCLUDED.**

SOME STATES DO NOT ALLOW LIMITATION ON HOW LONG AN IMPLIED WARRANTY LASTS OR EXCLUSION OR LIMITATION OF INCIDENTAL OR CONSEQUENTIAL DAMAGES, SO THE ABOVE LIMITATION OR EXCLUSION MAY NOT APPLY TO YOU.

THIS WARRANTY GIVES YOU SPECIFIC LEGAL RIGHTS, AND YOU MAY ALSO HAVE OTHER RIGHTS WHICH VARY FROM STATE TO STATE.

IF YOU NEED TO OBTAIN INFORMATION ABOUT THE NEAREST SERVICE CENTER, PLEASE CALL KOMATSU ZENOAH AMERICA INC. AT (770)-381-5147.

**IMPORTANT:** YOU WILL RECEIVE A WARRANTY REGISTRATION CARD AT TIME OF PURCHASE. PLEASE FILL OUT THE CARD AND SEND IT TO RedMax / KOMATSU ZENOAH AMERICA WITHIN SEVEN (7) DAYS. BE SURE TO KEEP A COPY FOR YOUR RECORDS.

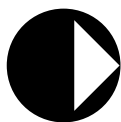

**RedMax**<sup>®</sup>

KOMATSU ZENOAH AMERICA INC.  
1505 Pavilion Place Suite A  
Norcross, Georgia 30093



KOMATSU ZENOAH AMERICA INC.  
1505 Pavilion Place Suite A  
Norcross, Georgia 30093