

Husqvarna, Wire saw accessory list, 2007-39

Wire saw

Tillbehör

Accessories

Zubehöre

Accessoires

Accesorios



Offset pulley systems

Offset pulley system
504 01 21-01

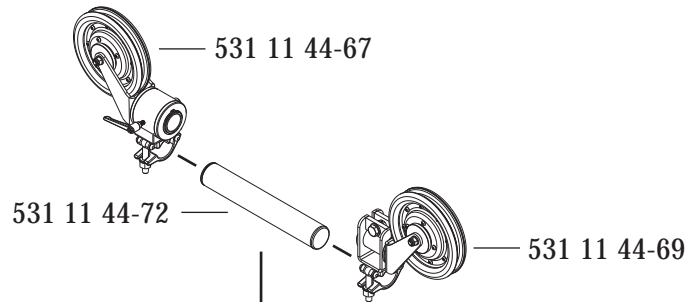



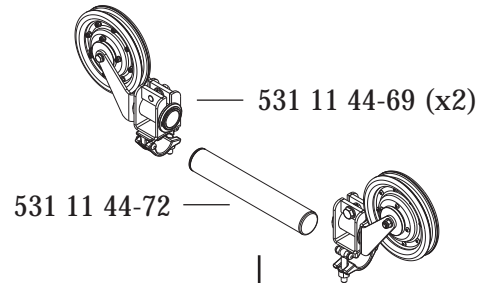

Offset pulley system
504 01 19-01

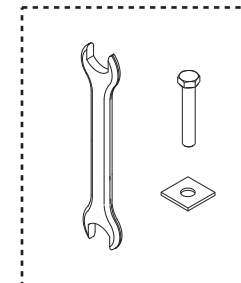
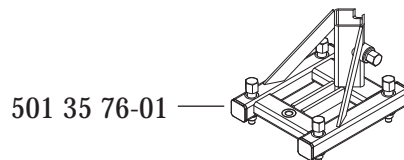
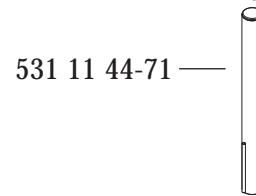
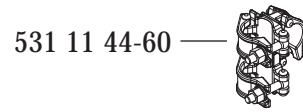
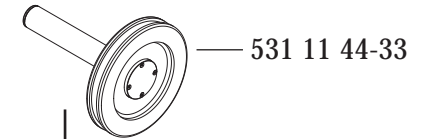

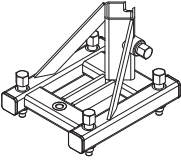
Single pulley system
504 01 20-01

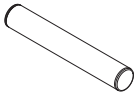
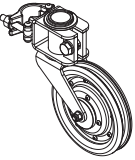
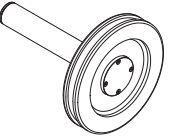
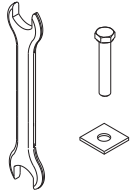

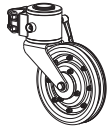
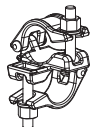
<i>Consists of</i> <i>Part No. complete</i>	 Foot 501 35 76-01	 Column pipe 531 11 44-71	 Double clamp 531 11 44-60	 Pipe 250mm 531 11 44-72	 Pulley 531 11 44-69	 Single pulley 531 11 44-33	 Tool and screw kit 531 11 44-75
Offset pulley system 504 01 19-01	X	X	X	X	X (2 pcs.)		X
Single pulley system 504 01 20-01	X	X	X			X	X
Offset pulley system special 504 01 21-01	X	X	X	X	X		X

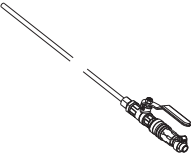
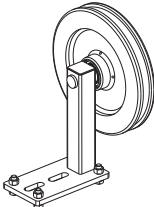
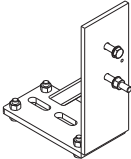
<i>Consists of</i> <i>Part No. complete</i>	 Pulley with bearings 531 11 44-67	 Normal clamp 531 11 95-71	 Pipe 48,3x1m 531 12 06-41	 Pipe 48,3x2m 531 12 06-42	 Water lance 531 12 15-25	 Pulley 531 11 30-33	 Angle plate, pulley 531 11 31-35
Offset pulley system 504 01 19-01							
Single pulley system 504 01 20-01							
Offset pulley system special 504 01 21-01	X						