

FSP 2000 Art. 7878
FSP 3000 Art. 7879

FSP 5500 DUO Art. 7880
FSP 8000 DUO Art. 7881
FSP 15000 DUO Art. 7882

- D Betriebsanleitung**
Filter- / Bachlaufpumpe
-
- GB Operating Instructions**
Filter / Stream Pump
-
- F Mode d'emploi**
Pompe pour filtre / cascade
-
- NL Instructies voor gebruik**
Filter- / Beeklooppomp
-
- S Bruksanvisning**
Filter / Pump för bäcksegment
-
- I Istruzioni per l'uso**
Pompa per filtri e per ruscelli
-
- E Manual de instrucciones**
Bomba para filtrar o de arroyo
-
- P Instruções de manejo**
Bomba de filtragem / ribeiro
-
- DK Brugsanvisning**
Filter- / vandløbspumpe

GARDENA Filter / Stream Pump FSP 2000 / FSP 3000 FSP 5500 DUO / FSP 8000 DUO / FSP 15000 DUO

Welcome to the Garden of GARDENA ...



Translation of the original instructions from German. Please read these operating instructions carefully and observe the notes given. Use these operating instructions to get to know the GARDENA Filter / Stream pump, its correct use and the safety instructions.



For safety reasons, children under 16 as well as persons not familiar with these operating instructions should not use this GARDENA Filter / Stream Pump.

→ Keep these operating instructions in a safe place.

Contents

1. Where to use Your GARDENA Filter / Stream Pump	8
2. For Your Safety	8
3. Initial Operation	9
4. Operating Your Filter / Stream Pump	10
5. Maintenance	10
6. Trouble-shooting	10
7. Storing your Fountain Pump Set	11
8. Accessories	11
9. Technical Data	12
10. Service	12

1. Where to use Your GARDENA Filter / Stream Pump

Intended Use

The GARDENA Filter / Stream Pump is intended for domestic use. It is not designed for operating watering tools and accessories or irrigation systems. The pump can be used both indoors and outdoors. The pump is intended for pumping dirty water or for use with streams.

Please note



The GARDENA Filter / Stream Pump is not suitable for continuous operation in industrial applications. Corrosive, easily combustible, aggressive or explosive substances, (such as gasoline, petroleum or nitro thinner), saltwater and food must not be pumped.

2. For Your Safety

Electrical Safety:

The pump should be operated via a residual current device with a residual current rating of ≤ 30 mA (DIN VDE 0100-702 and 0100-738). The pump must be placed on solid, even ground.

→ Please ask your electrician for his advice.

Always disconnect the pump from the mains before undertaking any work on it.

Mains power cables should not have a smaller cross-section than a rubber sheathed cable of the designation H05 RN-F3G0,75 (art. no. 7880, art. no. 7881 H05 RN-F3G1 / art. no. 7882 H07 RN-F3G1). Extension cables must meet the requirements of DIN VDE 0620.

Check line voltage. Data indicated on the type plate must match technical data of the mains supply.

Please unplug the pump after operation and before carrying out any maintenance works.

The pump must not be operated when there are people in the water. Swimming pools and garden ponds should be designed according to international and national design regulations.

→ Please consult a professional electrician.

For Austria:

Pumps for use on swimming pools and on ponds may only be operated via an isolating transformer.

→ Please consult a professional electrician.

For Switzerland:

In Switzerland mobile appliances which are used outdoors, must be connected via a residual-current device.

Note:

Do not allow the pump to run without water because dry-running leads to an undesirable build up of heat.

Before operating the pump, look to see if there is any damage of the pump (esp. regarding power cable and plug). The connection cable of the pump cannot be replaced. If the cable is damaged the pump must be scrapped. Ensure that the power cable cannot be crushed if it has not been laid in conduit in the earth or in gravel.

Do not use the power cable to carry the pump or to pull the plug out of the socket. Protect the power cable from heat, oil and sharp edges.

The temperature of the liquid used must not be below 4 °C or above 35 °C.

Sand and other abrasive substances in the liquid cause increased wear and reduce the output of the pump.

Please observe the local noise prevention regulations.

3. Initial Operation

Connecting the hose:

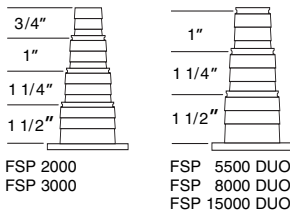

The universal connector ① can be used to connect 3/4" (for FSP 2000 / FSP 3000 only), 1", 1 1/4" and 1 1/2" hoses.

To achieve the best pumping results (maximum delivery rate of the pump) use a 38 mm (1 1/2")-hose. We recommend that you secure all hoses using **GARDENA Hose Clips art. no. 7192 - 7195**.

1. Depending on the hose, cut away the parts of the universal connector you do not need using a saw.
Otherwise loss of performance could occur.
2. Screw universal connector ① on to the pump.
3. Connect hose to the universal connector ①.

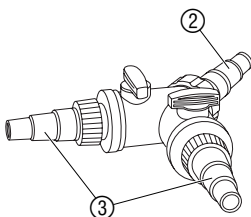
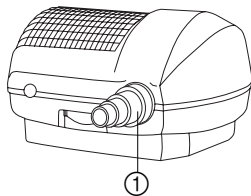

Only for FSP 5500 DUO / FSP 8000 DUO / FSP 15000 Duo:

4. Screw universal connector with ball and socket joint on to the distribution intake ②.
5. Screw universal connectors without ball and socket joint on to the distribution outlets ③.
6. Connect pump hose to the distribution intake ②.
7. Connect the hoses of the consumers (filter / stream) to the distribution outputs ③.

4. Operating Your Filter / Stream Pump

Switch pump on:

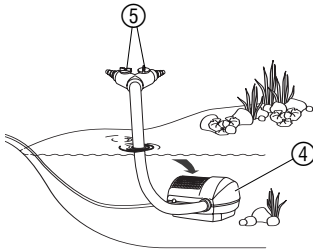

If using a pond filter, separate the filter outlet and the pump by as much distance as possible.

Note the maximum submersion depth (see **9. Technical Data**).

1. Place the pump in the water in such a way that the filter housing (4) is covered by at least 20 cm of water.
2. Plug mains plug into an AC socket.
Warning: Pump will start immediately.

Only for FSP 5500 DUO / FSP 8000 DUO / FSP 15000 Duo:

3. Set the quantity of water required for the consumers (filter / stream) with the two regulators (5) (if there is only one consumer, close the other regulator).

Note: When in continuous operation, small fish and e.g. newts are kept away from the pump. When operated with intervals, it would be possible for small animals to enter the pump.

5. Maintenance



Warning! Electric shock!

→ **Disconnect the pump from the mains before working on it.**

Clean filter housing:

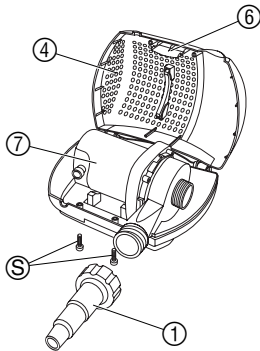

1. Take filter / stream pump out of the water.
2. Unscrew universal connector (1).
3. Unscrew the screws (5).
4. Press in snap fastening (6) and open up the filter housing (4).
5. Remove pump (7) and clean the filter housing (4) with a jet of water.
6. Re-assemble pump (7) in reverse order.

Do not use any hard objects or powerful detergents for cleaning the set!

6. Trouble-shooting

Clean the pump:



Warning! Electric shock!

→ **Disconnect the pump from the mains before working on it.**

1. Remove pump from the filter housing (see **5. Maintenance**).

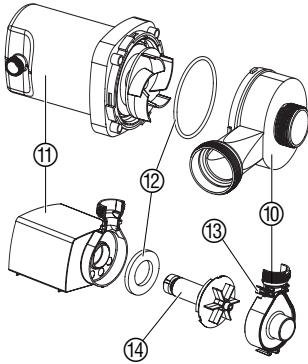

2. **FSP 5500 DUO / FSP 8000 DUO / FSP 15000 DUO**: Turn pump housing ⑩ anti-clockwise and pull vertically off the motor housing ⑪.
FSP 2000 / FSP 3000: Release the catches ⑬ and pull the pump housing ⑩ off the motor housing ⑪.

3. Clean the motor housing ⑪ and pump housing ⑩.
4. **FSP 2000 / FSP 3000**: Pull the impeller unit ⑭ out of the motor housing ⑪ clean and push back into the motor housing ⑪.

During assembly, ensure that the seal / foam filter ⑫ is correctly seated in the motor housing ⑪.

5. **FSP 5500 DUO / FSP 8000 DUO / FSP 15000 DUO**: Press pump housing ⑩ vertically onto the motor housing ⑪. and turn clockwise.
FP 2000 / FP 3000: Press pump housing ⑩ onto the motor housing ⑪.

Fault	Possible Cause	Remedy
No water being conveyed	Mains plug not plugged in.	→ Plug in mains plug.
	Impeller unit blocked.	→ Clean pump.
	Thermal overload switch has been activated (pump has run dry).	1. Unplug the mains plug and allow the pump to cool. 2. Plug the mains plug back in after approx. 2 minutes.
Reduced amount of water being conveyed	Filter housing is dirty.	→ Clean filter housing.

If any other faults arise, please contact GARDENA Service.

7. Storing your Fountain Pump Set

Overwintering:



The pump should be stored out of the reach of children.

1. Remove the pump from the pond before frost is expected and clean.
2. To avoid difficulties when starting up in the spring, we recommend storing the pump in a frost-free location in a container filled with water.
The mains plug must not be submerged.

Disposal:
 (in accordance with
 RL 2002/96/EC)



The product must not be added to normal household waste. It must be disposed of in line with local environmental regulations.

8. Accessories

GARDENA pond filter	Cleaning garden ponds with and without fish.
GARDENA Pond Construction Products	For designing and creating your own water feature. (e.g. a stream).
GARDENA Hoses	For connection between pump and filter.

9. Technical Data

Type	FSP 2000	FSP 3000	FSP 5500 DUO	FSP 8000 DUO	FSP 15000 DUO
Art.-No.	7878	7879	7880	7881	7882
Rated power	35 W	55 W	90 W	120 W	250 W
Max. Flow	2000 l/h	2800 l/h	5500 l/h	8100 l/h	14500 l/h
Max. delivery head	2,0 m	2,6 m	3,5 m	4,0 m	5,0 m
Max. submersion depth	2 m	2 m	4 m	4 m	4 m
Power cable	H05 RN-F3G0,75		H05 RN-F3G1,0		H07 RN-F3G1,0
Pump universal connections	3/4" / 1" / 1 1/4" / 1 1/2"			1" / 1 1/4" / 1 1/2"	
Media temperature	4°C – 35°C			4°C – 35°C	
Mains voltage / Frequency	230 V / 50 Hz			230 V / 50 Hz	

10. Service

Guarantee

GARDENA guarantees this product for 3 years (from date of purchase). This guarantee covers all serious defects of the unit that can be proved to be material or manufacturing faults. Under warranty we will either replace the unit or repair it free of charge if the following conditions apply:

- The unit must have been handled properly and in keeping with the requirements of the operating instructions.
- Neither the purchaser or a non-authorised third party have attempted to repair the unit.

The feed impeller is a wearing part and is not covered by the warranty.

This manufacturer's guarantee does not affect the user's existing warranty claims against the dealer/seller.

If you have any problems with your GARDENA Filter / Stream Pump, please contact our Service or return the defective unit together with a short description of the problem – in case of guarantee, with a copy of the receipt – postage paid to one of the GARDENA Service Centres listed on the back of this leaflet.

<p>D <i>Produkthftung</i></p>	<p>Wir weisen ausdrücklich darauf hin, dass wir nach dem Produkthaftungsgesetz nicht für durch unsere Geräte hervorgerufene Schäden einzustehen haben, sofern diese durch unsachgemäße Reparatur verursacht oder bei einem Teileaustausch nicht unsere Original GARDENA Teile oder von uns freigegebene Teile verwendet werden und die Reparatur nicht vom GARDENA Service oder dem autorisierten Fachmann durchgeführt wird. Entsprechendes gilt für Ergänzungssteile und Zubehör.</p>
<p>GB <i>Product Liability</i></p>	<p>We expressly point out that, in accordance with the product liability law, we are not liable for any damage caused by our units if it is due to improper repair or if parts exchanged are not original GARDENA parts or parts approved by us, and, if the repairs were not carried out by a GARDENA Service Centre or an authorised specialist. The same applies to spare parts and accessories.</p>
<p>F <i>Responsabilité</i></p>	<p>Nous vous signalons expressément que GARDENA n'est pas responsable des dommages causés par ses appareils, dans la mesure où ces dommages seraient causés suite à une réparation non conforme, dans la mesure où, lors d'un échange de pièces, les pièces d'origine GARDENA n'auraient pas été utilisées, ou si la réparation n'a pas été effectuée par le Service Après-Vente GARDENA ou l'un des Centres SAV agréés GARDENA. Ceci est également valable pour tout ajout de pièces et d'accessoires autres que ceux préconisés par GARDENA.</p>
<p>NL <i>Productaansprakelijkheid</i></p>	<p>Wij wijzen er nadrukkelijk op, dat wij op grond van de wet aansprakelijkheid voor producten niet aansprakelijk zijn voor schade ontstaan door onze apparaten, indien deze door onvakkundige reparatie veroorzaakt zijn, of er bij het uitwisselen van onderdelen geen gebruik gemaakt werd van onze originele GARDENA onderdelen of door ons vrijgegeven onderdelen en de reparatie niet door de GARDENA technische dienst of de bevoegde vakman uitgevoerd werd. Ditzelfde geldt voor extra-onderdelen en accessoires.</p>
<p>S <i>Produktansvar</i></p>	<p>Tillverkaren är inte ansvarig för skada som orsakats av produkten om skadan beror på att produkten har reparerats felaktigt eller om, vid reparation eller utbyte, andra än Original GARDENA reservdelar har använts. Samma sak gäller för kompletteringsdelar och tillbehör.</p>
<p>I <i>Responsabilità del prodotto</i></p>	<p>Si rende espressamente noto che, conformemente alla legislazione sulla responsabilità del prodotto, non si risponde di danni causati da nostri articoli se originati da riparazioni eseguite non correttamente o da sostituzioni di parti effettuate con materiale non originale GARDENA o comunque da noi non approvato e, in ogni caso, qualora l'intervento non venga eseguito da un centro assistenza GARDENA o da personale specializzato autorizzato. Lo stesso vale per le parti complementari e gli accessori.</p>
<p>E <i>Responsabilidad de productos</i></p>	<p>Advertimos que conforme a la ley de responsabilidad de productos no nos responsabilizamos de daños causados por nuestros aparatos, siempre y cuando dichos daños hayan sido originados por arreglos o reparaciones indebidas, por recambios con piezas que no sean piezas originales GARDENA o bien piezas autorizadas por nosotros, así como en aquellos casos en que la reparación no haya sido efectuada por un Servicio Técnico GARDENA o por un técnico autorizado. Lo mismo es aplicable para las piezas complementarias y accesorios.</p>
<p>P <i>Responsabilidade sobre o produto</i></p>	<p>Queremos salientar que segundo a lei da responsabilidade do fabricante, nós não nos responsabilizaremos por danos causados pelo nosso equipamento, quando estes ocorram em decorrência de reparações inadequadas ou da substituição de peças por peças não originais da GARDENA, ou peças não autorizadas. A responsabilidade tornar-se-à nula também depois de reparações realizadas por oficinas não autorizadas pela GARDENA. Esta restrição valerá também para peças adicionais e acessórios.</p>
<p>DK <i>Produktansvar</i></p>	<p>Vi gør udtrykkeligt opmærksom på at i henhold til produktansvarsloven er vi ikke ansvarlige for skader forårsaget af vores udstyr, hvis det skyldes uautoriserede reparationer eller hvis dele er skiftet ud og der ikke er anvendt originale GARDENA dele eller dele godkendt af os, eller hvis reparationerne ikke er udført af GARDENA-service eller en autoriseret fagmand. Det samme gælder for ekstra udstyr og tilbehør.</p>

<p>D EU-Konformitätserklärung Maschinenverordnung (9. GSGVO) / EMVG / Niedersp. RL Der Unterzeichnete GARDENA Manufacturing GmbH, Hans-Lorenser-Str. 40, D-89079 Ulm, bestätigt, dass die nachfolgend bezeichneten Geräte in der von uns in Verkehr gebrachten Ausführung die Anforderungen der harmonisierten EU-Richtlinien, EU-Sicherheitsstandards und produktspezifischen Standards erfüllen. Bei einer nicht mit uns abgestimmten Änderung der Geräte verliert diese Erklärung ihre Gültigkeit.</p>	<p>Bezeichnung der Geräte: Filter-/Bachlaufpumpe Description of the units: Fountain Pumps Désignation du matériel : Pompe pour filtre / cascade Omschrijving van de apparaten: Filter-/Beeklooppomp Produktbeskrivning: Filter/Pump för bäcksegment Descrizione dei prodotti: Pompa per filtri e per ruscelli Descripción de la mercancía: Bomba para filtrar o de arroyo</p>
<p>GB EU Certificate of Conformity The undersigned GARDENA IManufacturing GmbH, Hans-Lorenser-Str. 40, D-89079 Ulm, hereby certifies that, when leaving our factory, the units indicated below are in accordance with the harmonised EU guidelines, EU standards of safety and product specific standards. This certificate becomes void if the units are modified without our approval.</p>	<p>Descrição do aparelho: Bomba de filtragem / ribeiro Beskrivelse af enhederne: Springvandspumper</p>
<p>F Certificat de conformité aux directives européennes Le constructeur, soussigné : GARDENA Manufacturing GmbH, Hans-Lorenser-Str. 40, D-89079 Ulm, déclare qu'à la sortie de ses usines le matériel neuf désigné ci-dessous était conforme aux prescriptions des directives européennes énoncées ci-après et conforme aux règles de sécurité et autres règles qui lui sont applicables dans le cadre de l'Union européenne. Toute modification portée sur ce produit sans l'accord express de GARDENA supprime la validité de ce certificat.</p>	<p>Typ: FSP 2000 Art.-Nr.: 7878 Type: Art. No.: Type : FSP 3000 Référence : 7879 Typ: Art. nr.: Typ: FSP 5500 DUO Art.nr.: 7880 Modello: Art. : Tipo: FSP 8000 DUO Art. Nº: 7881 Tipo: Art. Nº: Type: FSP 15000 DUO Varenr. : 7882</p>
<p>NL EU-overeenstemmingsverklaring Ondergetekende GARDENA Manufacturing GmbH, Hans-Lorenser-Str. 40, D-89079 Ulm, bevestigt, dat de volgende genoemde apparaten in de door ons in de handel gebrachte uitvoering voldoen aan de eis van, en in overeenstemming zijn met de EU-richtlijnen, de EU-veiligheidsstandaard en de voor het product specifieke standaard. Bij een niet met ons afgestemde verandering aan de apparaten verliest deze verklaring haar geldigheid.</p>	<p>EU-Richtlijnen: 98/37/EC : 1998 EU directives: 2006/42/EC : 2006 Directives européennes : EU-richtlijnen: EU direktiv: 2004/108/EC Direttive UE: 2006/95/EC Normativa UE: Directrizes da UE: 93/68/EC EU Retningslinier:</p>
<p>S EU Tillverkarintyg Undertecknad firma GARDENA Manufacturing GmbH, Hans-Lorenser-Str. 40, D-89079 Ulm, intygar härmed att nedan nämnda produkter överensstämmer med EU:s direktiv, EU:s säkerhetsstandard och produktspecifikation. Detta intyg upphör att gälla om produkten ändras utan vårt tillstånd.</p>	<p>Harmonisierte EN: EN ISO 12100-1 EN ISO 12100-2 EN 60335-1 EN 60335-2-41</p>
<p>I Dichiarazione di conformità alle norme UE La sottoscritta GARDENA Manufacturing GmbH, Hans-Lorenser-Str. 40, D-89079 Ulm, certifica che il prodotto qui di seguito indicato, nei modelli da noi commercializzati, è conforme alle direttive armonizzate UE nonché agli standard di sicurezza e agli standard specifici di prodotto. Qualunque modifica apportata al prodotto senza nostra specifica autorizzazione invalida la presente dichiarazione.</p>	<p>Anbringningsjahr der CE-Kennzeichnung: Year of CE marking: Date d'apposition du marquage CE : Installatiejaar van de CE-aanduiding: 2003 CE-Märkningsår: Anno di rilascio della certificazione CE: Colocación del distintivo CE: Ano de marcação pela CE: CE-Mærkningsår:</p>
<p>E Declaración de conformidad de la UE El que suscribe GARDENA Manufacturing GmbH, Hans-Lorenser-Str. 40, D-89079 Ulm, declara que la presente mercancía, objeto de la presente declaración, cumple con todas las normas de la UE, en lo que a normas técnicas, de homologación y de seguridad se refiere. En caso de realizar cualquier modificación en la presente mercancía sin nuestra previa autorización, esta declaración pierde su validez.</p>	
<p>P Certificado de conformidad da UE Os abaixo mencionados GARDENA Manufacturing GmbH, Hans-Lorenser-Str. 40, D-89079 Ulm, por este meio certificam que ao sair da fábrica o aparelho abaixo mencionado está de acordo com as diretrizes harmonizadas da UE, padrões de segurança e de produtos específicos. Este certificado ficará nulo se a unidade for modificada sem a nossa aprovação.</p>	<p> Dr. Friedrich Böbel Technische Leitung Technical Dept. Manager Direction technique Hoofd technische dienst Technical Director Direzione Tecnica Dirección Técnica Director Técnico Teknisk direktør</p>
<p>DK EU Overensstemmelse certificat Undertegnede GARDENA Manufacturing GmbH, Hans-Lorenser-Str. 40, D-89079 Ulm bekræfter hermed, at enheder listet herunder, ved afsendelse fra fabrikken, er i overensstemmelse med harmoniserede EU retningslinier, EU sikkerhedsstandarder og produktspecifikationsstandarder. Dette certifikat træder ud af kraft hvis enhederne er ændret uden vor godkendelse.</p>	<p>Ulm, den 11.09.2003 Ulm, 11.09.2003 Fait à Ulm, le 11.09.2003 Ulm, 11-09-2003 Ulm, 2003.09.11 Ulm, 11.09.2003 Ulm, 11.09.2003 Ulm, 11.09.2003 Ulm, 11.09.2003 Ulm, 11.09.2003</p>

FSP 2000: Art. 7878

Pumpen-Kennlinie
Performance characteristics
Courbes de performance
Prestatiegrafiek
Kapacitetskurva
Curva di rendimento
Curva característica
de la bomba
Características
de performance
Ydelses karakteristika

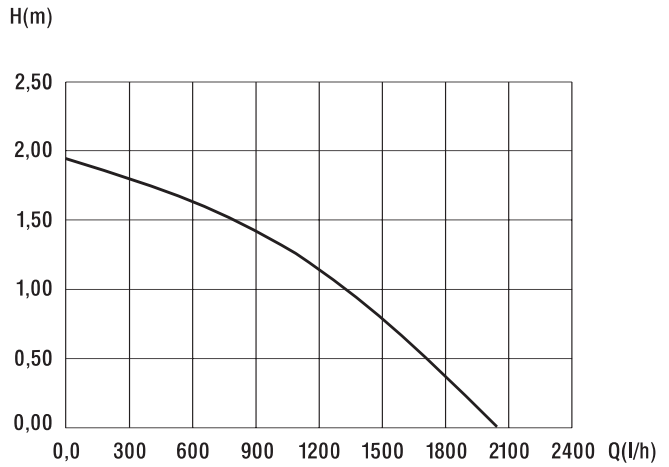

FSP 3000: Art. 7879

Pumpen-Kennlinie
Performance characteristics
Courbes de performance
Prestatiegrafiek
Kapacitetskurva
Curva di rendimento
Curva característica
de la bomba
Características
de performance
Ydelses karakteristika

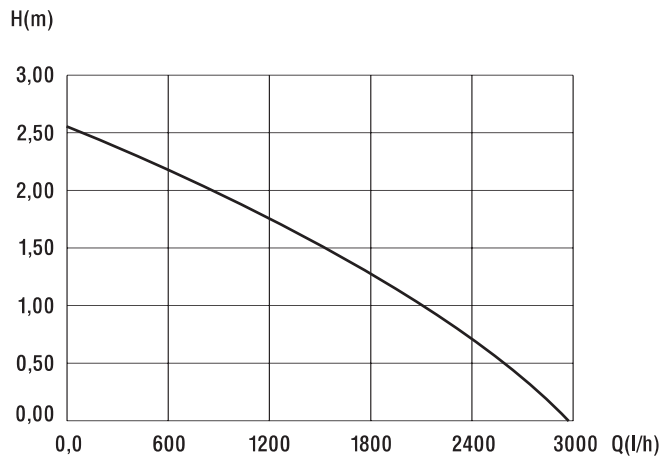

FSP 5500 DUO: Art. 7880

Pumpen-Kennlinie
Performance characteristics
Courbes de performance
Prestatiegrafiek
Kapacitetskurva
Curva di rendimento
Curva característica
de la bomba
Características
de performance
Ydelses karakteristika

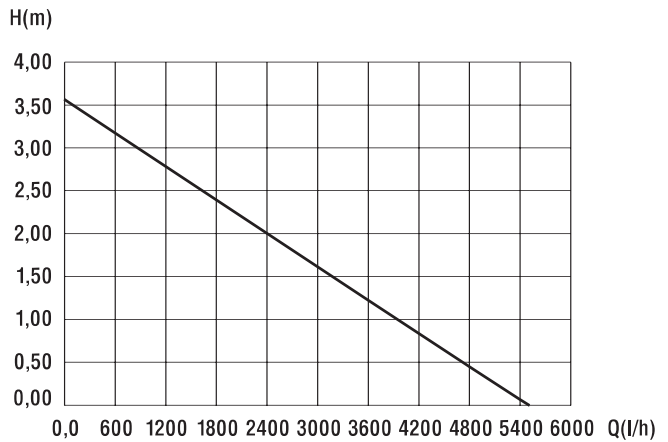

FSP 8000 DUO: Art. 7881

Pumpen-Kennlinie
Performance characteristics
Courbes de performance
Prestatiegrafiek
Kapacitetskurva
Curva di rendimento
Curva característica
de la bomba
Características
de performance
Ydelses karakteristika

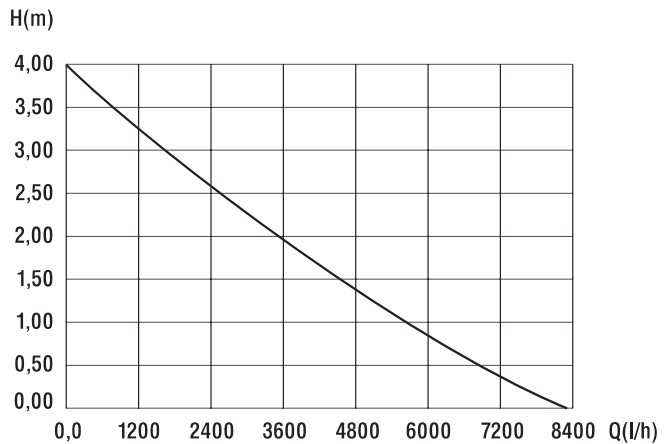

FSP 15000 DUO: Art. 7882

Pumpen-Kennlinie
Performance characteristics
Courbes de performance
Prestatiegrafiek
Kapacitetskurva
Curva di rendimento
Curva característica
de la bomba
Características
de performance
Ydelses karakteristika

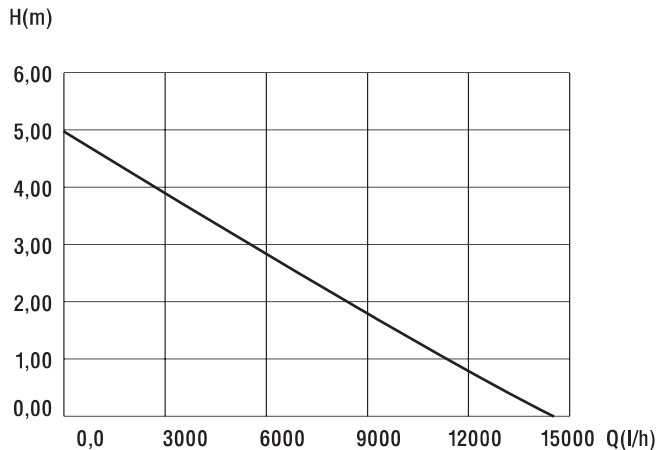

Deutschland / Germany

GARDENA
Manufacturing GmbH
Service Center
Hans-Lorenser-Straße 40
D-89079 Ulm
Produktfragen:
(+49) 731 490-123
Reparaturen:
(+49) 731 490-290
service@gardena.com

Argentina

Argensem® S.A.
Calle Colonia Japonesa s/n
(1625) Loma Verde
Escobar, Buenos Aires
Phone: (+54) 34 88 49 40 40
info@argensem.com.ar

Australia

Nylex Consumer Products
50-70 Stanley Drive
Somerton, Victoria, 3062
Phone: (+61) 1800 658 276
spare.parts@nylex.com.au

Austria / Österreich

GARDENA
Österreich Ges.m.b.H.
Stettnerweg 11-15
2100 Korneuburg
Tel.: (+43) 22 62 7 45 45 36
kundendienst@gardena.at

Belgium

GARDENA Belgium NV/SA
Sterrebeekstraat 163
1930 Zaventem
Phone: (+32) 2 7 20 92 12
Mail: info@gardena.be

Brazil

Palash Comércio e
Importação Ltda.
Rua São João do Araguaia,
338 – Jardim Califórnia –
Barueri – SP - Brasil –
CEP 06409-060
Phone: (+55) 11 4198-9777
eduardo@palash.com.br

Bulgaria

Хускварна България ЕООД
1799 София
Бул. „Андрей Ляпчев“ № 72
Тел.: 02/ 8755148, 9753076
www.husqvarna.bg

Canada

GARDENA Canada Ltd.
100 Summerlea Road
Brampton, Ontario L6T 4X3
Phone: (+1) 905 792 9330
info@gardenacanada.com

Chile

Antonio Martinic y Cia Ltda.
Cassillas 272
Centro de Cassillas
Santiago de Chile
Phone: (+56) 2 20 10 708
garfar_cl@yahoo.com

Costa Rica

Compania Exim
Euroberoamericana S.A.
Los Colegios, Moravia,
200 metros al Sur del Colegio
Saint Francis - San José
Phone: (+506) 297 68 83
exim_euro@racsa.co.cr

Croatia

KLIS d.o.o.
Stanciceva 79
10419 Vukovina
Phone: (+385) 1 622 777 0
gardena@klis-trgovina.hr

Cyprus

FARMOKIPIKI LTD
P.O. Box 7098
74, Digeni Akritia Ave.
1641 Nicosia
Phone: (+357) 2275 47 62
condam@spidernet.com.cy

Czech Republic

GARDENA spol. s r.o.
Tuřanka 115
627 00 Brno
Phone: (+420) 800 100 425
gardena@gardenabrno.cz

Denmark

GARDENA Norden AB
Salgsafdeling Danmark
Box 9003
S-200 39 Malmö
info@gardena.dk

Finland

Oy Husqvarna Ab
Lautatarhankatu 8b/ PL 3
FI-00581 HELSINKI

France

GARDENA
PARIS NORD 2
69, rue de la Belle Etoile
BP 57080
ROISSY EN FRANCE
95948 ROISSY CDG CEDEX
Tél. (+33) 0826 101 455
service.consommateurs@
gardena.fr

Great Britain

Husqvarna UK Ltd
Preston Road
Aycliffe Industrial Park
Newton Aycliffe
County Durham
DL5 6UP
info.gardena@husqvarna.co.uk

Greece

Agrokip
Psomadopoulos S.A.
Ifaistou 33A
Industrial Area Koropi
194 00 Athens Greece
V.A.T. EL093474846
Phone: (+30) 210 6620 225
service@agrokip.gr

Hungary

GARDENA
Magyarország Kft.
Késmárk utca 22
1158 Budapest
Phone: (+36) 80 20 40 33
gardena@gardena.hu

Iceland

Ó. Johnson & Kaaber
Tunguhalsi 1
110 Reykjavik
ooj@ojk.is

Ireland

Michael McLoughlin & Sons
Hardware Limited
Long Mile Road
Dublin 12

Italy

GARDENA Italia S.p.A.
Via Donizetti 22
20020 Lainate (Mi)
Phone: (+39) 02.93.94.79.1
info@gardenaitalia.it

Japan

KAKUICHI Co. Ltd.
Sumitomo Realty &
Development Kojimachi
BLDG., 8F
5-1 Nibanncyo, Chiyoda-ku
Tokyo 102-0084
Phone: (+81) 33 264 4721
m_ishihara@kaku-ichi.co.jp

Luxembourg

Magasins Jules Neuberg
39, rue Jacques Stas
Luxembourg-Gasperich 2549
Case Postale No. 12
Luxembourg 2010
Phone: (+352) 40 14 01
api@neuberg.lu

Netherlands

GARDENA Nederland B.V.
Postbus 50176
1305 AD ALMERE
Phone: (+31) 36 521 00 00
info@gardena.nl

Neth. Antilles

Jonka Enterprises N.V.
Sta. Rosa Weg 196
P.O. Box 8200, Curaçao
Phone: (+599) 9 767 66 55
pgm@jonka.com

New Zealand

NYLEX New Zealand Limited
Building 2, 118 Savill Drive
Mangere, Auckland
Phone: (+64) 0800 22 00 88
spare.parts@nylex.com.au

Norway

GARDENA Norden AB
Salgskontor Norge
Kleverveien 6
1540 Vestby
info@gardena.no

Poland

GARDENA Polska Sp. z o.o.
Szymanów 9 d
05-532 Baniocza
Phone: (+48) 22 727 56 90
gardena@gardena.pl

Portugal

GARDENA Portugal Lda.
Recta da Granja do Marquês
Edif. GARDENA Algueirão
2725-596 Mem Martins
Phone: (+351) 21 922 85 30
info@gardena.pt

Romania

MADEX INTERNATIONAL SRL
Soseaua Odaii 117-123,
Sector 1,
București, RO 013603
Phone: (+40) 21 352 76 03
madex@ines.ro

Russia / Россия

ООО ГАРДЕНА РУС
123007, г. Москва
Хорошевское шоссе, д. 32А
Тел.: (+7) 495 540 99 57
info@gardena-rus.ru

Singapore

Hy-Ray PRIVATE LIMITED
40 Jalan Pemimpin
#02-08 Tat Ann Building
Singapore 577185
Phone: (+65) 6253 2277
hyray@singnet.com.sg

Slovak Republic

GARDENA Slovensko, s.r.o.
Panónska cesta 17
851 04 Bratislava
Phone: (+421) 263 453 722
info@gardena.sk

Slovenia

GARDENA d.o.o.
Brodšče 15
1236 Trzin
Phone: (+386) 1 580 93 32
servis@gardena.si

South Africa

GARDENA
South Africa (Pty.) Ltd.
P.O. Box 11534
Vorna Valley 1686
Phone: (+27) 11 315 02 23
sales@gardena.co.za

Spain

GARDENA IBÉRICA S.L.U.
C/ Basauri, nº 6
La Florida
28023 Madrid
Phone: (+34) 91 708 05 00
atencioncliente@gardena.es

Sweden

GARDENA Norden AB
Försäljningskontor Sverige
Box 9003
200 39 Malmö
info@gardena.se

Switzerland / Schweiz

GARDENA (Schweiz) AG
Bitzberg 1
8184 Bächenbülach
Phone: (+41) 848 800 464
info@gardena.ch

Turkey

GARDENA / Dost Diş Ticaret
Mümesillik A.Ş. Sanayi
Çad. Adil Sokak No. 1
Kartal - İstanbul
Phone: (+90) 216 38 93 939
info@gardena-dost.com.tr

Ukraine / Україна

ALTSEST JSC
4 Petropavlivska Street
Petropavlivska
Borschahivka Town
Kyivo Svyatoshyyn Region
08130, Ukraine
Phone: (+380) 44 459 57 03
uprr@altsest.kiev.ua

USA

Melnor Inc.
3085 Shawnee Drive
Winchester, VA 22604
Phone: (+1) 540 722-9080
service_us@melnor.com

7878-20.960.08 / 1207
© GARDENA
Manufacturing GmbH
D-89070 Ulm
http://www.gardena.com