



Art. 19032

EN **Operator's manual**
smart Irrigation Control

GARDENA smart Irrigation Control 24 V

1. SAFETY	4
2. ASSEMBLY	6
3. INSTALLATION	8
4. OPERATION	19
5. MAINTENANCE	22
6. STORAGE	22
7. TROUBLESHOOTING	24
8. TECHNICAL DATA	26
9. ACCESSORIES	27
10. SERVICE/WARRANTY	28

Original instructions.



For safety reasons, children and young people under 16 as well as anyone who is not familiar with these operating instructions should not use the product. Persons with reduced physical or mental abilities may use the product only if they are supervised or instructed by a responsible person. Children must be supervised to ensure that they do not play with the product. Never operate the product when you are tired, ill or under the influence of alcohol, drugs or medicine.

Intended use:

The **GARDENA smart Irrigation Control** is intended for private use in domestic and hobby gardens, to control sprinklers and watering systems. It can be used for automatic watering during holidays. It is only intended for use in a weatherproof and dust-proof location. It is not intended for indoor use.

The **GARDENA smart Irrigation Control** is part of a garden irrigation system and can only be programmed together with the **GARDENA smart Gateway**.

The **GARDENA smart Irrigation Control** is configured via the **GARDENA smart system App** and controls the watering. Sprinklers, a sprinkler system or a drip head watering system can be used for watering.

The **GARDENA smart Irrigation Control** carries out watering fully automatically according to the set program and can therefore also be used during holidays.



DANGER! Risk of injury!

The product must not be used for industrial purposes or in conjunction with chemicals, foodstuffs, easily flammable and explosive materials.

1. SAFETY

Important!

Read the operator's manual carefully before use and keep for future reference.

Symbols on the product:



Read operator's manual.

Electrical safety



DANGER! Cardiac arrest!

This product makes an electromagnetic field while it operates. This field may under some conditions interfere with active or passive medical implants. To decrease the risk of conditions that can possibly injure or kill, we recommend persons with medical implants to speak with their physician and the medical implant manufacturer before you operate the product.



**DANGER!
Electric shock!**

Risk of injury due to electric shock.

- The product must be supplied through a residual current device (RCD) having a rated residual operating current not exceeding 30 mA.



CAUTION!

Only plug the transformer into the power outlet in a vertical position.

The product must only be operated with the 24 V (AC) power supply unit provided. Do not use an adapter.

Protect the 24 V (AC) power supply unit from moisture and direct sunlight when connected.

Install the irrigation control in a weatherproof location.

Check the power cord for damage before use.

The product must be used only for controlling commercially available 24 V (AC) valves. The electric power consumption per channel must not exceed 400 mA (a GARDENA Irrigation Valve Art. 1278 requires 150 mA).

Cable cross-section of the connection cable:

The maximum permissible distance between the product and the valve depends on the cross-section of the connection cable. For a distance of 30 m, the cross section is 0.5 mm² and 0.75 mm² for a distance of 45 m. No more than 3 valves must be in operation at the same time. The **GARDENA Connection Cable Art. 1280** is 0.5 mm² in size and is 15 m long.

Up to 6 valves can be connected using this cable. The connection cable can be connected so that it is watertight using the **GARDENA Cable Clip Art. 1282**.

Personal safety



DANGER!
Risk of suffocation!

Small parts can be easily swallowed. There is also a risk that the polybag can suffocate toddlers. Keep toddlers away when you assemble the product.

Protect the product from direct sunlight.



Be careful when touching the valves!

Metal parts can heat up.

2. ASSEMBLY

To assemble the irrigation control on the wall:

The both screws and dowels are in the scope of delivery.

The distance between the holes is 120 mm.

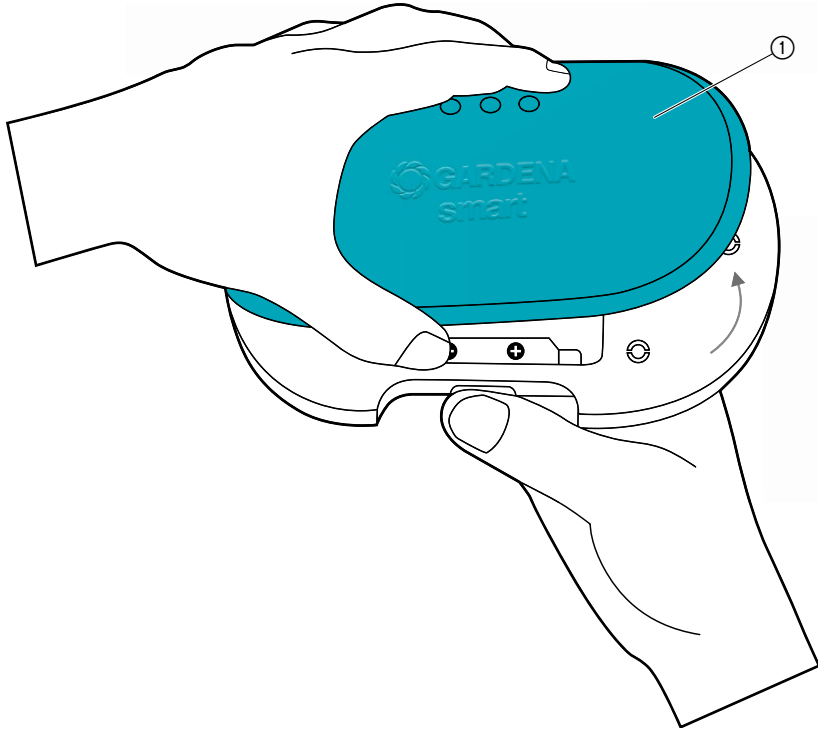

1. Remove the cover ①.

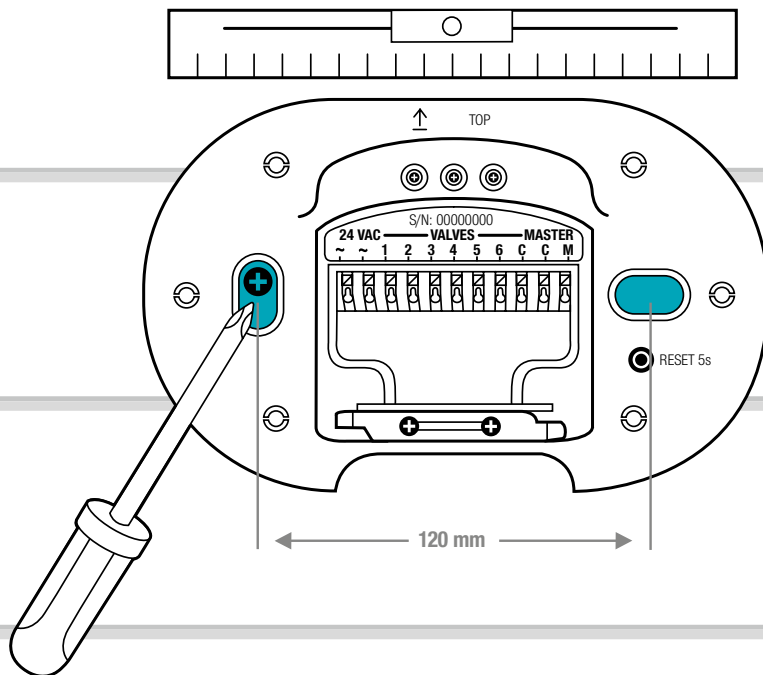

2. Mark the positions of the holes. To do this, hold the Irrigation Control against the wall, bring it straight and mark 2 holes at a distance of 120 mm.
3. Drill the holes and assemble the Irrigation Control to the wall with the 2 plugs and screws supplied.

NOTE:

The cables must be led downwards!

Pay attention to the cable lengths, especially during initial installation.

If you want to mount several irrigation controls, the distance between the holes is 150 mm.

Due to the cable routing, up to 3 Irrigation Controls can be assembled on top of each other.

3. INSTALLATION

To remove the cable strain relief:

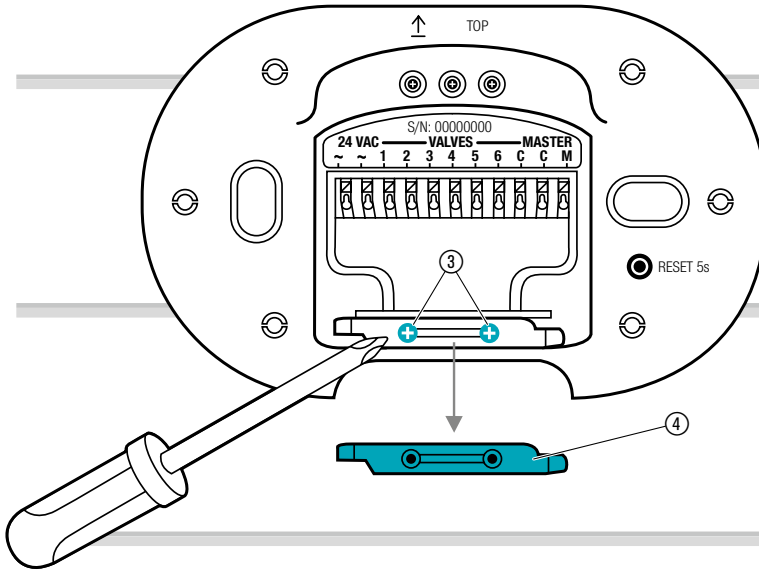

→ Loosen both screws ③ and remove the cable strain relief ④.

Connection overview:

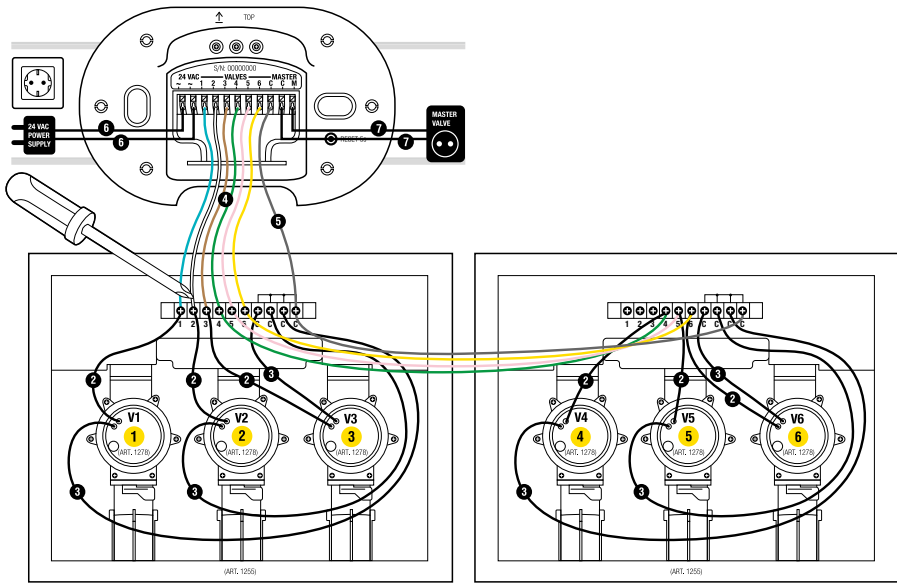

Valve Box Art. 1255

Valve Box Art. 1255

To connect the valves to the Valve Box:

Make sure that the terminal block has been correctly installed in the valve box.

1

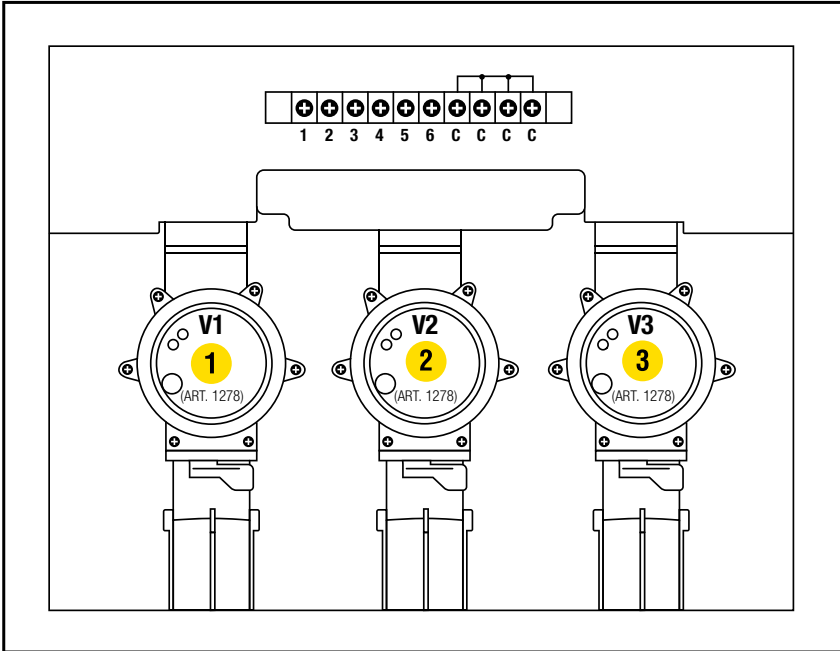

→ Label the valves (1 – 6) with the yellow stickers of the valve box.
 (Therefore the signal cable terminals **VALVES 1 – 6** of the Irrigation Control can be clearly assigned to the valves).

2

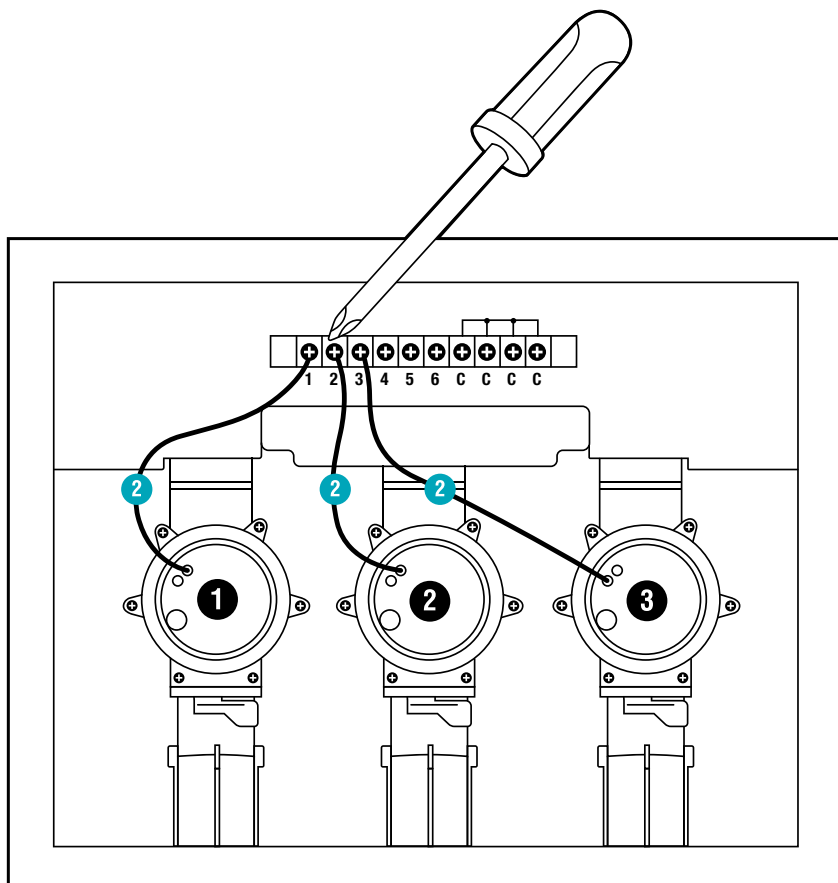

- Connect a cable of the valve **V1** to the signal cable terminal **1** of the Valve Box.
- Connect a cable of the valve **V2** to the signal cable terminal **2** of the Valve Box.
- Connect a cable of the valve **V3** to the signal cable terminal **4** of the Valve Box.

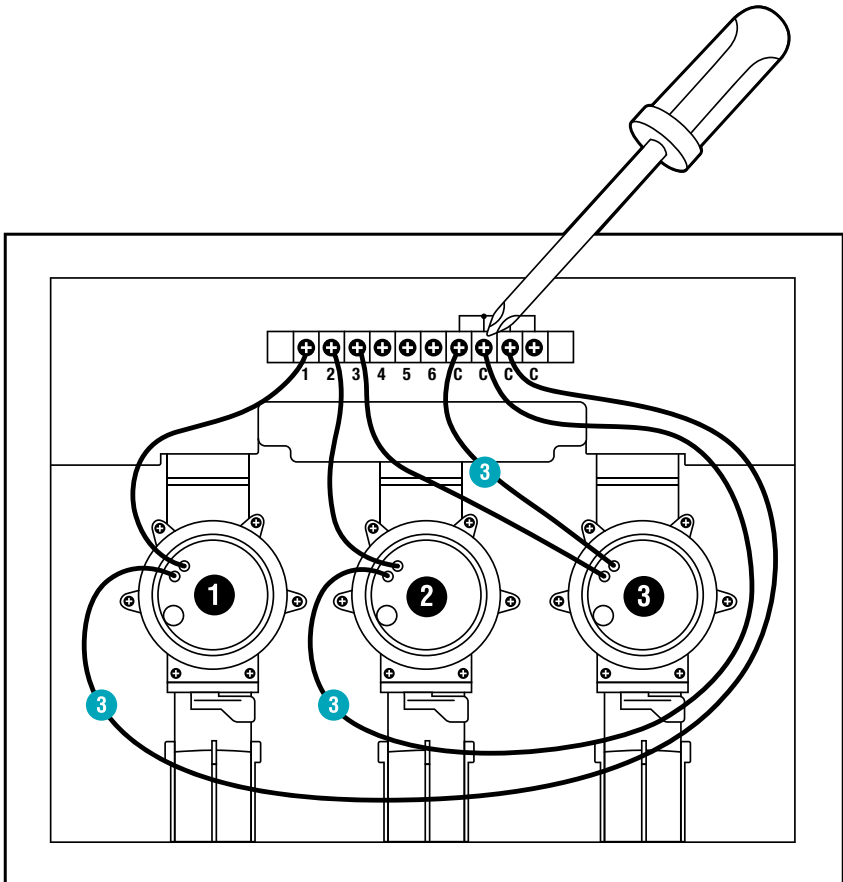

- Connect the other cable of the valve **V1** to a signal cable terminal **C** of the Valve Box.
*(All 4 signal cable terminals **C** are connected to each other and equivalent).*
- Connect the other cable of the valve **V2** to a signal cable terminal **C** of the Valve Box.
- Connect the other cable of the valve **V3** to a signal cable terminal **C** of the Valve Box.

To connect the Valve Box to the Irrigation Control:

Tip: Press down the signal cable terminal with your index finger, screwdriver or ballpoint pen to connect the cables.

With the **GARDENA Connection Cable Art. 1280** you can connect up to **6 valves** with the Irrigation Control.

4

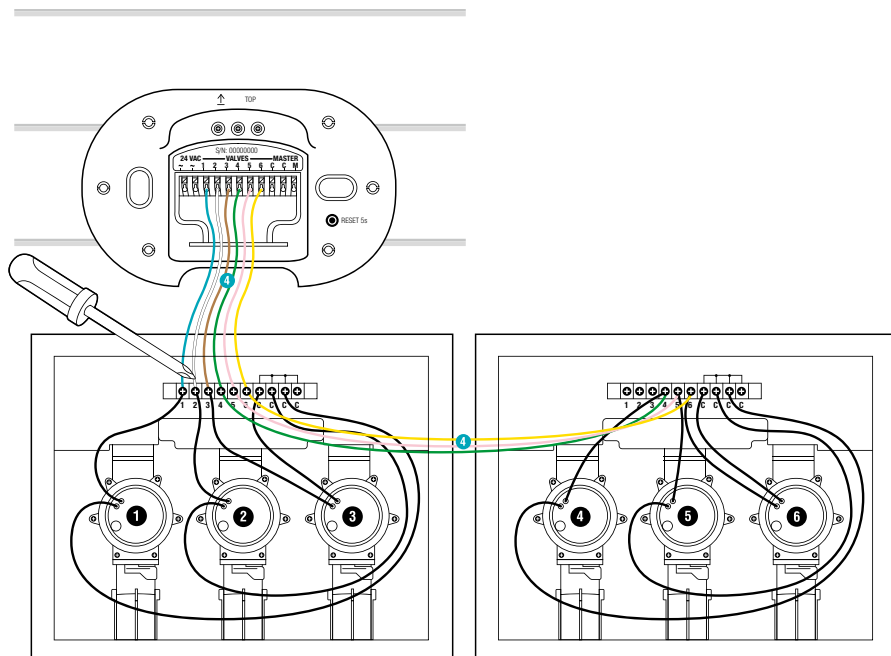

- Connect the signal cable terminal **1** of the Valve Box to the signal cable terminal **VALVES 1** of the Irrigation Control.
- Connect the signal cable terminal **2** of the Valve Box to the signal cable terminal **VALVES 2** of the Irrigation Control.
- Connect the signal cable terminal **3** of the Valve Box to the signal cable terminal **VALVES 3** of the Irrigation Control.

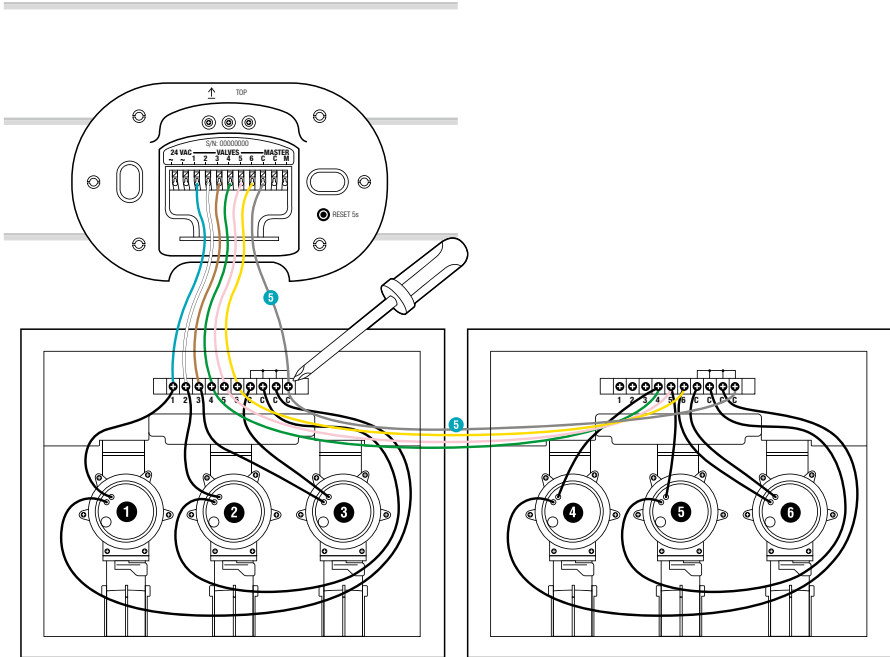

→ Connect one signal cable terminal **C** of the Valve Box to the blue signal signal cable terminal **C** of the Irrigation Control.

To connect the master valve:

Master Channel:

The master channel **M** is activated, as soon as a valve is activated.

You can connect a central valve upstream of the other valves to act as a master valve.

6

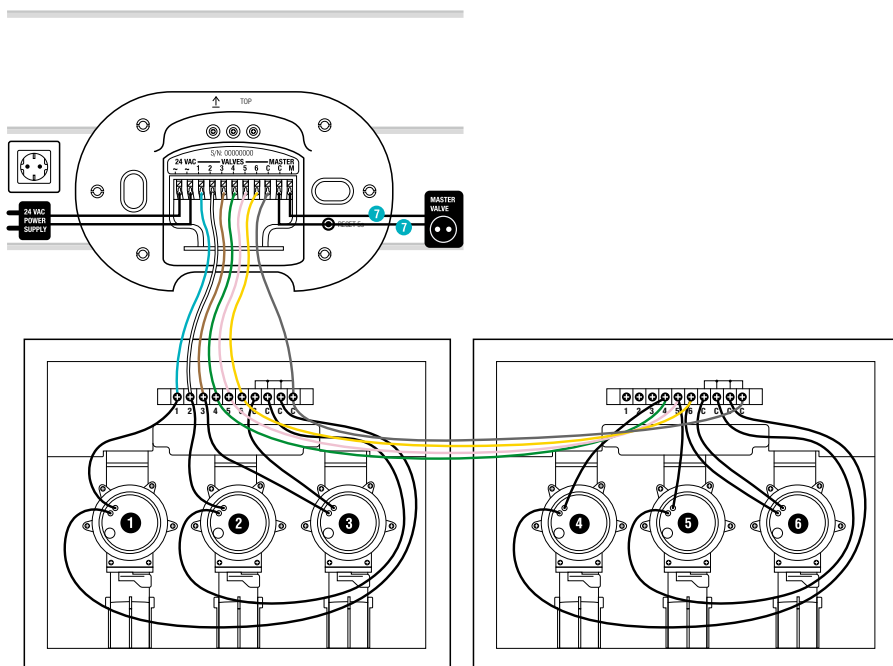

→ Connect both cables to the signal cable terminals **M** and **C** of the Irrigation Control (polarity does not have to be considered).

To connect the power supply:



CAUTION!

The irrigation control is damaged if the power supply unit is connected to cable terminals other than the 24 V (AC) cable terminals!

→ Connect the power supply unit to the 24 V (AC) terminals only!



CAUTION!

Damaging of the irrigation control system by short circuit!

→ Check all wiring before you plug in the power supply.

7

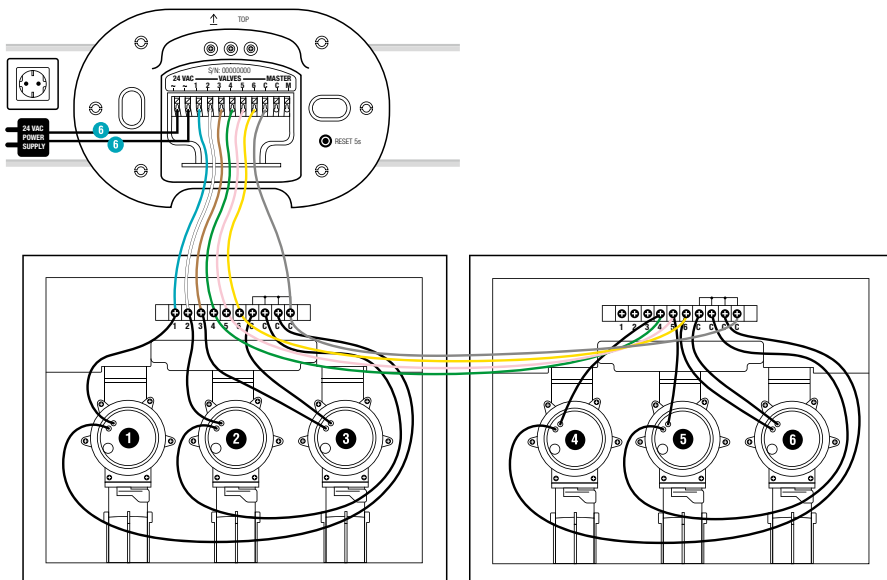

1. Connect both cables to the cable terminals **24 V (AC)** of the Irrigation Control (polarity does not have to be considered).
2. Plug the power supply unit into an socket.

To close the cover:

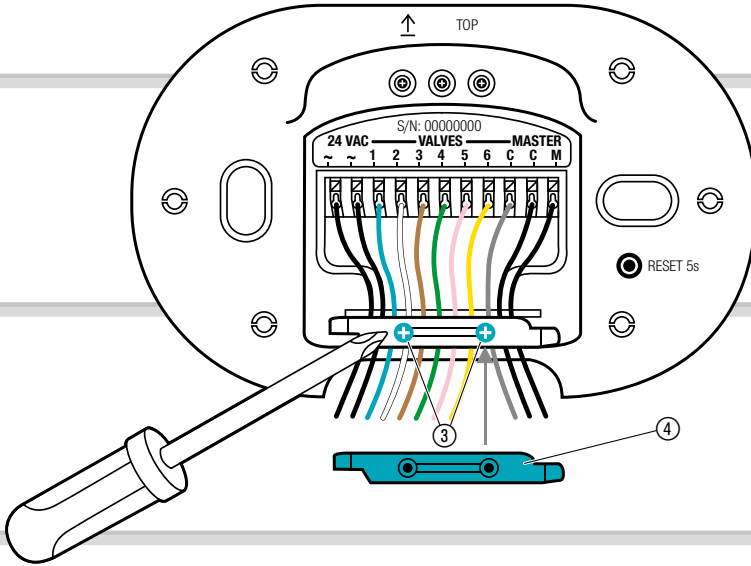

1. Attach the cable strain relief ④ and tighten the two screws ③.

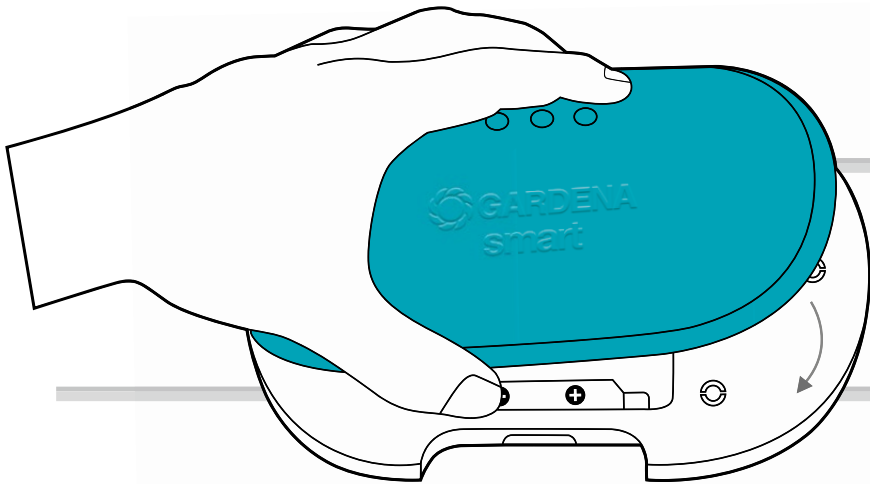

2. Push the cover onto the Irrigation Control.

4. OPERATION

LED Display:

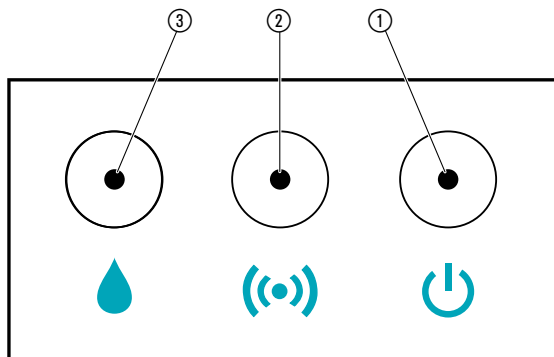

- ① **LED Power:**
Green: Power On
- ② **LED Connection display/Signal:**
Green flashing: While connecting
Green: Signal strength high
Yellow: Signal strength medium
Red: Signal strength low
Red flashing: Inclusion mode failed
- ③ **LED Active watering:**
Green: Active watering
Red flashing: Valve error (see 7. TROUBLESHOOTING)

Operation with the GARDENA smart system App:

You can use the **GARDENA smart system app** to control all smart system products from anywhere at any time. You can download the free **GARDENA smart system app** from the Apple App Store or from the Google Play Store.

In order to include, a **GARDENA smart Gateway** with internet connectivity is needed. All GARDENA smart products are integrated via the app. Follow the instructions inside the App.

Settings of the Irrigation Control:

- According to the timings in the smart system App:
Watering days, start, duration
- As required in the smart system App:
Start and finish

Factory Reset:

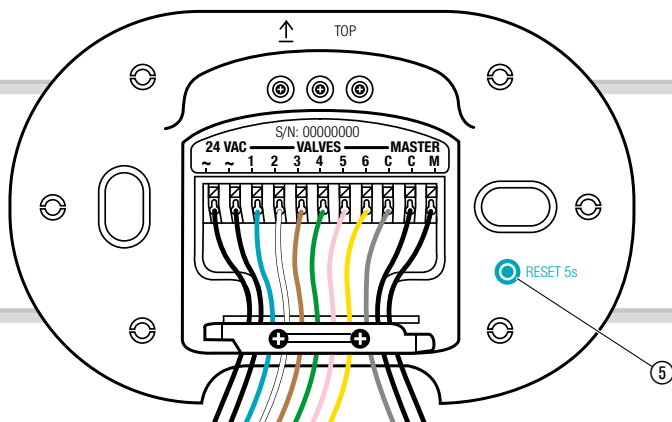

The smart Irrigation Control will be reset to the factory settings.

→ Push the Reset key ⑤ for a short time.
New connection.

- or -

→ Push and hold down the Reset key ⑤ for at least 5 seconds.
 Cancels the existing connection and allows a new connection to be established, e. g. different Gateway.

5. MAINTENANCE

To clean the Irrigation Control:

Do not use caustic / abrasive cleaning agents.

→ Clean the Irrigation Control with a damp cloth (do not use solvent).

6. STORAGE

To put into storage:

The product must be stored away from children.

The irrigation valves may become permanently damaged if exposed to temperatures below 5 °C. We advise you to take the following measures before the onset of frost:

1. Close the tap and detach the connecting hose between the tap and the GARDENA Connecting Point, Art. 2722.
2. If the irrigation system is connected directly to your house's water system: Turn off the water supply and open the drain cock in the water pipe for the house.
3. Set the selection lever on all valves to the "ON" position.
4. Drain the irrigation valve/valve box.

This can be done in the following ways:

- Drain the system using compressed air

– or –

- remove all valves and store in a frost-free place

– or –

- for the Valve Box V3, open the drain cap and drain the supply pipe. As long as the pipes coming from the Valve Box V3 outlets are drained via a drain valve (e. g. in the GARDENA pop-up sprinklers) which is not attached at a higher point than the irrigation valve, the irrigation valves can be left mounted in the valve box.
- The smart Irrigation Control can remain installed after it has been deactivated.

Disposal:

(in accordance with RL2012/19/EC)





The product must not be disposed of to normal household waste. It must be disposed of in line with local environmental regulations.

IMPORTANT!

Dispose of the product through or via your municipal recycling collection centre.

7. TROUBLESHOOTING

Problem	Possible Cause	Remedy
 LED Power illuminates red	Undervoltage	→ Check the power connection.
	Wrong power supply.	→ Check the power supply.
	MCU Communication error.	→ Reset the irrigation control to factory settings.
 LED Active Watering flashes red	Can't open valve because of limit of 2.	→ Check the program.
	Valve is not connected.	→ Check the valve.
	Single channel overcurrent.	→ Check the current of the channel.
	Sum overcurrent.	→ Check the sum current of the valves.
	Watering schedule cancelled.	→ Restart the program.
	Master channel error	→ Check the master channel.
	Watering duration too short.	→ Increase the watering duration
Watering program is not being undertaken (no watering)	The valve has previously been manually opened.	→ Avoid any program overlap.
	Water tap closed.	→ Open the water tap.
No function	Faulty wiring.	→ Check the cable terminals.
	Power supply unit is not connected.	→ Connect the power supply unit.
	Power supply unit is too hot.	→ Disconnect the power supply unit and let it be cooled down. Connect the power supply unit again.
		→ Protect the power supply unit from direct sunlight.
Inclusion is not possible (Inclusion)	No wireless connection to the Gateway.	→ Select another position for the irrigation control or the Gateway.
	No power supply available.	→ Check the mains cable.

Problem	Possible Cause	Remedy
Irrigation Control does not respond	Faulty wiring.	→ Check the cable terminals.
	No wireless connection to the Gateway.	→ Check the wireless connection to the Gateway.



NOTE: For any other malfunctions please contact the GARDENA service department. Repairs must only be done by GARDENA service departments or specialist dealers approved by GARDENA.

8. TECHNICAL DATA

	Unit	Value (Art. 19032)
Operation temperature range (outdoors)	°C	+5 – +40
<i>SRD:</i>		
Frequency range	MHz	863 – 870
Maximum power	mW	25
Free field radio range (approx.)	m	100
<i>Power supply</i>		
Mains voltage	V (AC)	230 – 240
Mains frequency	Hz	50
Rated Power	W	22
Standby power (approx.)	W	3
Output voltage	V (AC)	24
Max. Output current	mA	600

EC Declaration of Conformity:

Hereby, GARDENA Manufacturing GmbH declares that the radio equipment type (Art. 19032) is in compliance with directive 2014/53/EU.

The full text of the EC declaration of conformity is available at the following internet address:

<http://www.gardena.com/int/support/safety-regulations>

9. ACCESSORIES

GARDENA smart Sensor	Art. 19030
GARDENA Watering Valve 24V	Art. 1278
GARDENA Valve Boxes	Art. 1254/1255
GARDENA Connection Cable	Art. 1280
GARDENA Cable Clips	Art. 1282

10. SERVICE/WARRANTY

Service:

Please contact the address on the back page.

Warranty statement:

In the event of a warranty claim, no charge is levied to you for the services provided.

GARDENA Manufacturing GmbH grants a warranty for all original GARDENA new products for two years from the date of original purchase from the retailer, provided that the devices have been for private use only. This manufacturer's warranty does not apply to products acquired second hand. This warranty includes all significant defects of the product that can be proved to be material or manufacturing faults. This warranty is fulfilled by supplying a fully functional replacement product or by repairing the faulty product sent to us free of charge; we reserve the right to choose between these options. This service is subject to the following provisions:

- The product has been used for its intended purpose as per the recommendations in the operating instructions.
- Neither the purchaser nor a third party has attempted to open or repair the product.
- Only Original GARDENA replacement parts and wear parts have been used for operation.
- Presentation of the receipt.

Normal wear and tear of parts and components (such as blades, blade fixing parts, turbines, light bulbs, V-belts/toothed belts, impellers, air filters, spark plugs), visual changes, wear parts and consumables are excluded from the warranty.

This manufacturer's warranty is limited to replacement and repair of products in accordance with the abovementioned conditions. The manufacturer's warranty does not constitute an entitlement to lodge other claims against us as a manufacturer, such as for damages. This manufacturer's warranty does **not**, of course, affect statutory and contractual warranty claims against the dealer/retailer.

The manufacturer's warranty is governed by the law of the Federal Republic of Germany.

In case of a warranty claim, please return the faulty product, together with a copy of the receipt and a description of the fault, with postage paid to the service address.

Product liability:

In accordance with the German Product Liability Act, we hereby expressly declare that we accept no liability for damage incurred from our products where said products have not been properly repaired by a GARDENA approved service partner or where original GARDENA parts or parts authorised by GARDENA were not used.

Deutschland / Germany

GARDENA
Manufacturing GmbH
Central Service
Hans-Lorenser-Straße 40
D-89079 Ulm
Produktfragen:
(+49) 731 490-123
Reparaturen:
(+49) 731 490-290
service@gardena.com
http://www.gardena.com

Albania

KRAFT SHPK
Autostrada Tirane-Durres
Km 7
1051 Tirane

Argentina

ROBERTO C. RUMBO S.R.L.
Predio Norlog
Lote 7
Benavidez, ZC:1621
Buenos Aires
ventas@rumbosrl.com.ar

Armenia

Garden Land Ltd.
61 Tigran Mets
0005 Yerevan

Australia

Husqvarna Australia Pty. Ltd.
Locked Bag 5
Central Coast BC
NSW 2252
Phone: (+61) (0) 2 4352 7400
customer.service@
husqvarna.com.au

Austria / Österreich

Husqvarna Austria GmbH
Industriezeile 36
4010 Linz
Tel.: (+43) 732 77 01 01-485
service.gardena@
husqvarnagroup.com

Azerbaijan

Firm Progress
a. Aliyev Str. 26A
1052 Baku

Belarus

Private Enterprise
"Master Garden"
Minsk
Sharangovich str., 7a
Phone: (+375) 17 257-00-33
Mob.: (+375) 29 676-16-09
mg@mastergarden.by

Belgium

Husqvarna Belgium nv
Gardena Division
Leuvensesteenweg 542
Planet II E
1930 Zaventem
België

Bosnia / Herzegovina

SILK TRADE d.o.o.
Industrijska zona Bukva bb
74260 Tešanj

Brazil

Husqvarna do Brasil Ltda
Av. Francisco Matarazzo,
1400 - 19° andar
São Paulo - SP
CEP: 05001-903
Tel: 0800-112252
marketing.br.husqvarna@
husqvarna.com.br

Bulgaria

AGROLAND България АД
бул. 8 Декември, №13
Офис 5
1700 Студентски град
София
Тел.: (+359) 24666910
info@agroland.eu

Canada / USA

GARDENA Canada Ltd.
100 Summerlea Road
Brampton, Ontario L6T 4X3
Phone: (+1) 905 792 93 30
info@gardenacanada.com

Chile

REPRESENTACIONES
JCE S.A.
Av. Del Valle Norte 857,
Piso 4
Santiago RM
Phone: (+56) 2 24142560
contacto@jce.cl

China

Husqvarna (Shanghai)
Management Co., Ltd.
富世华 (上海) 管理有限公司
3F, Benq Square B,
No207, Song Hong Rd.,
Chang Ning District,
Shanghai
PRC. 200335
上海市长宁区沁虹路207号明
基广场B座3楼, 邮编: 200335

Colombia

Husqvarna Colombia S.A.
Calle 18 No. 68 D-31, zona
Industrial de Montevideo
Bogotá, Cundinamarca
Tel. 571 2922700 ext. 105
jairo.salazar@
husqvarna.com.co

Costa Rica

Compania Exim
Euroberoamericana S.A.
Los Colegios, Moravia,
200 metros al Sur del Colegio
Saint Francis - San José
Phone: (+506) 297 68 83
exim_euro@racsa.co.cr

Croatia

Husqvarna Austria GmbH
Industriezeile 36
4010 Linz
Tel.: (+43) 732 77 01 01-485
service.gardena@
husqvarnagroup.com

Cyprus

Med Marketing
17 Digeni Akrita Ave
P.O. Box 27017
1641 Nicosia

Czech Republic

Husqvarna Česko s.r.o.
Türkova 2319/5b
149 00 Praha 4 - Chodov
Bezplatná infolinka:
800 100 425
servis@cz.husqvarna.com

Denmark

GARDENA DANMARK
Løjrvvej 19, st.
3500 Værløse
Tlf.: (+45) 70264770
husqvarna@husqvarna.dk
www.gardena.com/dk

Dominican Republic

BOSQUESA, S.R.L
Carretera Santiago Licey
Km. 5 ½
Esquina Copal II.
Santiago
Dominican Republic
Phone: (+809) 736-0333
joserbosquesa@claro.net.do

Ecuador

Husqvarna Ecuador S.A.
Arupos E1-181 y 10 de
Agosto Quito, Pichincha
Tel. (+593) 22800739
francisco.jacom@
husqvarna.com.ec

Estonia

Husqvarna Eesti OÜ
Valdeku 132
EE-11216 Tallinn
info@gardena.ee

Finland

Oy Husqvarna Ab
Gardena Division
Lauttarhankatu 8 B / PL 3
00581 HELSINKI
www.gardena.fi

France

Husqvarna France
9/11 Allée des pierres mayettes
92635 Gennevilliers Cedex
France
http://www.gardena.com/fr
N° AZUR: 0 810 00 78 23
(Prix d'un appel local)

Georgia

Transporter LLC
8/57 Beliasvili street
0159 Tbilisi, Georgia
Phone: (+995) 322 14 71 71

Great Britain

Husqvarna UK Ltd
Preston Road
Aycliffe Industrial Park
Newton Aycliffe
County Durham
DL5 6UP
info.gardena@
husqvarna.co.uk

Greece

Π.ΠΑΠΑΔΟΠΟΥΛΟΣ ΑΕΒΕ
Λεωφ. Αθηνών 92
Αθήνα
T.K. 104 42
Ελλάδα
Τηλ. (+30) 210 5193100
info@papadopoulos.com.gr

Hungary

Husqvarna Magyarország Kft.
Ezred u. 1-3
1044 Budapest
Telefon: (+36) 1 251-4161
vevozzolgalat.husqvarna@
husqvarna.hu

Iceland

BYKO ehf.
Bildishóla 20
110 Reykjavik

Ireland

Husqvarna UK Ltd
Preston Road
Aycliffe Industrial Park
Newton Aycliffe
County Durham
DL5 6UP
info.gardena@
husqvarna.co.uk

Italy

Husqvarna Italia S.p.A.
Via Santa Vecchia 15
23868 VALMADRERA (LC)
Phone: (+39) 0341.203.111
assistenza.italia@
it.husqvarna.com

Japan

Husqvarna Zenoah Co., Ltd.
1-19 Miramida
Kawagoe
350-1165 Saitama
gardena-jp@
husqvarnagroup.com

Kazakhstan

LAMED Ltd.
155/11, Tazhibayevoy Str.
050060 Almaty
IP Schmidt
Abayavenue 3B
110 005 Kostanay

Korea

Kyung Jin Trading CO.,LTD.
107-4, SunDuk Bld.,
YangJae-dong,
Seocho-gu,
Seoul, (zipcode: 137-891)
Phone: (+82) (0)2 574-6300

Kyrgyzstan

Alye Maki
av. Moladaya Guardir J 3
720014
Bishkek

Latvia

Husqvarna Latvija SIA
Ulbroskas 19A
LV-1021 Rīga
info@gardena.lv

Lithuania

UAB Husqvarna Lietuva
Ateities pl. 77C
LT-52104 Kaunas
info@gardena.lt

Luxembourg

Magasins Jules Neuberg
39, rue Jacques Stas
Luxembourg-Gasperich 2549
Case Postale No. 12
Luxembourg 2010
Phone: (+352) 40 14 01
api@neuberg.lu

Mexico

AFOSA
Av. Lopez Mateos Sur # 5019
Col. La Calma 45070
Zapopan, Jalisco
Mexico
Phone: (+52) 33 3818-3434
icornejo@afoosa.com.mx

Moldova

Convel S.R.L.
290A Muncesti Str.
2002 Chisinau

Netherlands

Husqvarna Nederland B.V.
GARDENA Division
Postbus 50131
1305 AC ALMERE
Phone: (+31) 36 521 00 10
info@gardena.nl

Neth. Antilles

Jonka Enterprises N.V.
Sta. Rosa Weg 196
P.O. Box 8200
Curaçao
Phone: (+599) 9 767 66 55
pgm@jonka.com

New Zealand

Husqvarna New Zealand Ltd.
PO Box 76-437
Manukau City 2241
Phone: (+64) (0) 9 9202410
support.nz@husqvarna.co.nz

Norway

Husqvarna Norge AS
Gardena Division
Trøskeneveien 36
1708 Sarpsborg
info@gardena.no

Peru

Husqvarna Peru S.A.
Jr. Ramón Cárcamo 710
Lima 1
Tel: (+51) 1 3320400
ext. 416
juan.remuzgo@
husqvarna.com

Poland

Husqvarna
Poland Spółka z o.o.
ul. Wysockiego 15 b
03-371 Warszawa
Phone: (+48) 22 330 96 00
gardena@husqvarna.com.pl

Portugal

Husqvarna Portugal, SA
Lagoa - Albarraque
2635 - 595 Rio de Mouro
Tel.: (+351) 21 922 85 30
Fax: (+351) 21 922 85 36
info@gardena.pt

Romania

Madex International Srl
Sosseua Odaii 117-123,
RO 013603 Bucuresti, S 1
Phone: (+40) 21 352.76.03
madex@ines.ro

Russia / Россия

ООО „Хускварна“
141400, Московская обл.,
г. Химки,
улица Ленинградская,
владение 39, стр.6
Бизнес Центр
„Химки Бизнес Парк“,
поселение ОБО2_04
http://www.gardena.ru

Serbia

Domel d.o.o.
Autoput za Novi Sad bb
11273 Belgrade
Phone: (+381) 11 848 88 12
miroslav.jejina@domel.rs

Singapore

Hy-Ray PRIVATE LIMITED
40 Jalan Pemimpin
#02-08 Tat Ann Building
Singapore 577185
Phone: (+65) 6253 2277
shiyang@hyray.com.sg

Slovak Republic

Husqvarna Cesko s.r.o.
Türkova 2319/5b
149 00 Praha 4 - Chodov
Bezplatná infolinka: 800 154 044
servis@sk.husqvarna.com

Slovenia

Husqvarna Austria GmbH
Industriezeile 36
4010 Linz
Tel.: (+43) 732 77 01 01-485
service.gardena@
husqvarnagroup.com

South Africa

Husqvarna South Africa (Pty) Ltd
Postnet Suite 250
Private Bag X6
Cascades, 3202, South Africa
Phone: (+27) 33 846 9700
info@gardena.co.za

Spain

Husqvarna España S.A.
Calle de Rivas nº10
28052 Madrid
Phone: (+34) 91 708 05 00
atencioncliente@gardena.es

Suriname

Deto Handelmaatschappij N.V.
Kernkampweg 72-74
P.O.Box: 12782
Paramaribo - Suriname
South America
Phone: (+597) 438050
www.deto sr

Sweden

Husqvarna AB /
GARDENA Sverige
Drottninggatan 2
561 82 Huskvarna Sverige

Switzerland / Schweiz

Husqvarna Schweiz AG
Consumer Products
Industriestrasse 10
5506 Mägenwil
Phone: (+41) (0) 62 887 37 90
info@gardena.ch

Turkey

Dost Bahçe Diş Ticaret
Müesseslikli A.Ş
Yunus Mah. Adil Sok. No:3
Ic Kapı No: 1 Kantal
34873 Istanbul
Phone: (+90) 216 38 93 939
info@dostbahce.com.tr

Ukraine / Україна

ТОВ «Хускварна Україна»
вул. Васильківська, 34,
офіс 204-р
03022, м. Київ
Тел. (+380) 0 800 504 804
info@gardena.ua

Uruguay

FLI SA
Entre Rios 1083 CP 1800
Montevideo - Uruguay
Tel: (+598) 22 03 18 44
info@felisa.com.uy

Venezuela

Corporación Casa y Jardin C.A.
Av. Caroní, Edif. Trezmen, PB.
Colinas de Bello Monte.
1050 Caracas.
Tlf: (+58) 212 992 33 22
info@casayjardin.net.ve

19032-20.962.03/1120
© GARDENA Manufacturing GmbH
D-89079 Ulm
http://www.gardena.com