

C 1060 plus Art. 1864

- GB Operating Instructions**
Water Computer
-
- F Mode d'emploi**
Programmateur d'arrosage
-
- NL Instructies voor gebruik**
Besproeiingscomputer
-
- S Bruksanvisning**
Bevattningscomputer
-
- DK Brugsanvisning**
Vandingscomputer
-
- RUS Инструкция по эксплуатации**
Компьютер для полива

GARDENA Water Computer C 1060 plus

Welcome to the Garden of GARDENA...



Translation of the original instructions from German. Please read these operating instructions carefully and observe the notes given. Use these instructions to familiarise yourself with the Water Computer and its proper use as well as the notes on safety.



For safety reasons, children and young people under 16 as well as anyone who is not familiar with these operating instructions may not use the Water Computer.

→ Please keep these operating instructions in a safe place.

Contents

1. Where to Use Your GARDENA Water Computer C 1060 plus	2
2. Safety instructions	2
3. Function	3
4. Putting Your Water Computer into Operation	5
5. Programming	7
5.1 Basic programming	7
5.2 Special programs	10
5.3 Other settings	13
6. Putting Your Water Computer out of Operation	14
7. Maintenance	14
8. Troubleshooting	15
9. Available accessories	15
10. Technical Data	16
11. Service / Warranty	16

1. Where to Use Your GARDENA Water Computer C 1060 plus

Intended use:

The GARDENA Water Computer is intended for private use in domestic and hobby gardens, exclusively for outdoor use, to control sprinklers and watering systems. The Water Computer can be used for automatic watering during holidays.

Please note:



The GARDENA Water Computer must not be used for industrial purposes or in conjunction with chemicals, foodstuffs, easily flammable and explosive materials.

2. Safety instructions

Battery:

To ensure the Water Computer runs safely, only a 9 V alkaline manganese battery (alkaline) type IEC 6LR61 must be used.

In order to stop the Water Computer from failing because of a weak battery if you are away for a long time, the battery must be replaced when the battery display still shows only 1 bar.

Setting up

Warning!

The Water Computer must not be used indoors.

→ Only use the Water Computer outdoors.

The Water Computer may only be set up vertically with the sleeve nut to the top to prevent water penetrating into the battery compartment.

The minimum water output to ensure that the Water Computer functions correctly is 20-30 l/h.

For example, at least 10 x 2-litre Drip Heads are required to control the Micro-Drip-System.

At high temperatures (over 60 °C at the display) the LCD display may extinguish. This does not affect the program in any way.

When the computer cools down the LCD display illuminates again.

The max. temperature for the water flow is 40 °C.

→ Only use clear fresh water.

The minimum operating pressure is 0,5 bar, the maximum operating pressure is 12 bar.

Avoid tensile strain.

→ Do not pull the hose connected to the Water Computer.

Programming

→ Program the Water Computer with the tap turned off.

In this way you can avoid getting wet when trying out the manual On/Off function (man. On/Off). You can remove the control unit from the housing to program the Water Computer.

If the controller is removed when the valve is open, the valve remains open until the controller is fitted again.

3. Function

With the Water Computer, the garden can be watered fully automatically at any time of day. Sprinklers, a sprinkler system or a drip head watering system can be used for watering.

The Water Computer carries out watering fully automatically according to the set programs and can therefore also be used during holidays. Evaporation is lowest in the early morning or late evening.

Controls:

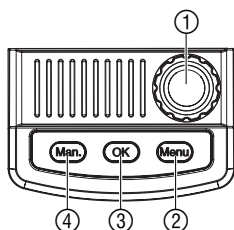

The watering programs are easily entered using the controls.

Control

Function

- | | |
|------------------------|--|
| ① Rotary button | Changes the adjustable values. |
| ② Menu button | Switches to the next display level. |
| ③ OK button | Applies the values set with the rotary button. |
| ④ Man. button | For switching the water throughput on or off manually. |

Display levels:

The 4 display levels,

- Level 1: **Normal display**
 - Level 2: **Current time and day of the week**
 - Level 3: **Enter watering programs**
 - Level 4: **Turning watering programs on and off**
- can be selected one after the other by pressing the **Menu** key.

You can change the display level at any time, even during programming. All program data that has been changed up till now and confirmed by pressing **OK** will be saved.

Display panel:

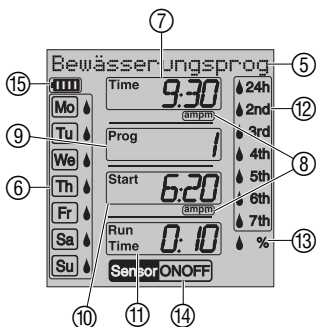

Display	Description
⑤ Ticker	Explanation of the program step / Computer status.
⑥ Weekdays (Mo), (Tu), ...	Current weekday or programmed watering days.
⑦ Time	Flashes when entering the current data (Time - hours, minutes, day of the week).
⑧ am / pm	Display for 12 hour clock (e. g. in USA, Canada).
⑨ Prog	Program-controlled watering (Prog 1 – 5) / % (percentage change in run time) (Prog 10) / Watering with automatic water distributor (Prog 11) / Soil moisture sensor-controlled watering (Prog 12 – 14) / Watering program on (ON) / off (OFF).
⑩ Start	Watering start time (flashes when in input mode).
⑪ Run Time	Watering duration (flashes when in input mode).
⑫ 24h, 2nd, 3rd, 4th 5th, 6th, 7th	Watering cycle (with drop symbol activated). Every 24 hours; every 2/3/4/5/6/7 days.
⑬ % (Run Time)	Budget function: Watering duration for all watering programs can be set centrally in 10% steps from 100% down to 10%.
⑬ Sensor ON / OFF	Sensor ON (watering) / Sensor OFF (watering is not carried out).
⑭ Battery 	Indicates 5 battery levels: 3 bars: Battery fully charged 2 bars: Battery half full 1 bar: Battery low 1 bar flashing: Battery almost flat 0 bar: Battery flat

If no bars are displayed, the valve is no longer opened. **A valve opened by the programme will also close again if the battery is flat.**

The **battery display** is reset when the battery is changed.

2 Bars	1 Bar	1 Bar flashing	0 Bar
Battery half full	Battery low	Battery almost flat	Battery flat
Valve opens.	Valve opens.	Valve still opens.	Valve does not open.
The Water Computer is guaranteed to work for a minimum of 4 more weeks.	The Water Computer will continue to work for no more than 4 weeks.	The Water Computer stops working soon.	The Water Computer stops working.
	It is advisable to change the battery.	The battery must be changed soon.	The battery must be changed.
	→ Replace battery (see 4. Putting Your Water Computer into Operation "Inserting battery").		

4. Putting Your Water Computer into Operation

Insert battery:

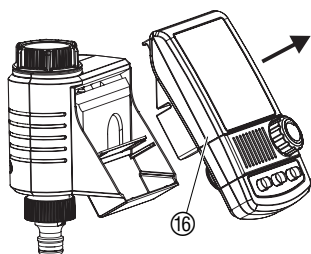

The Water Computer must only be operated with a 9 V alkali-manganese (alkaline) battery type IEC 6LR61.

1. Remove controller ⑯ from the housing of the Water Computer.
2. Insert battery in the battery compartment ⑰. **Observe correct polarity** Ⓟ.

The display shows all LCD symbols for 2 seconds and then switches to language selection. (see 5. Programming).

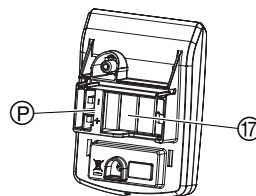

3. Install controller ⑯ on the housing again.

Connect Water Computer:

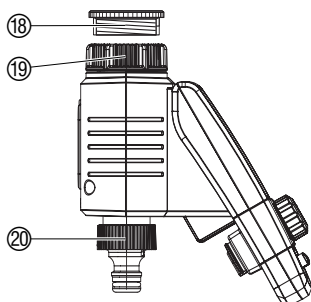

The Water Computer is fitted with a sleeve nut ⑱ for taps with (G 1") (33.3 mm) thread. The adapter supplied ⑱ is used to connect the Water Computer to the tap with 26.5 mm (G 3/4") threads.

1. **For 26.5 mm (G 3/4") threads:** Screw the adapter ⑱ to the tap by hand (do not use pliers).
2. Screw sleeve nut ⑱ of the Water Computer on to the adaptor thread by hand (do not use pliers).
3. Screw tap connector ⑳ on to the Water Computer.

Connect soil moisture or rain sensor (optional):

Apart from scheduled watering there is also the option of including how damp the soil is or rainfall into the watering programme.

If the soil is damp enough, the programme will be stopped, or a programme will be prevented from starting. Manual operation via Man. On / Off is unaffected by this.

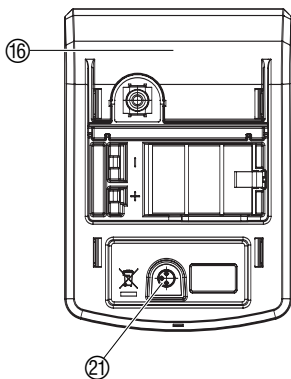

The “Soil moisture sensor-controlled watering” mode can only be selected when using a soil moisture sensor (see 5.2 Special programs).

1. Remove controller 16 from the housing of the Water Computer.
2. Place soil moisture sensor in the watered area
– or –
place rain sensor (with extension cable if necessary) outside the watered area.
3. Insert the sensor in the sensor connection 21 of the Water Computer.

An adapter cable may be required to connect older sensors, which can be purchased from GARDENA Service, **GARDENA Adapter cable Art. No. 1189-00.600.45.**

Fit anti-theft device (optional):

To secure your Water Computer against theft, you can obtain the **GARDENA Anti-theft device Art. No. 1815-00.791.00** from GARDENA Service.

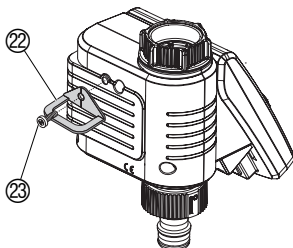

1. Screw clamp 22 with screw 23 firmly to the back of the Water Computer.
2. Use clamp 22 e.g. for fixing a chain.

It is no longer possible to remove the screw after it has been screwed in.

Compile watering plan:

Before you start entering the watering data in the computer we recommend that you write the data on one of the **watering plans in the appendix** to maintain more of an overview.

Example:

Program	Start time	Watering-duration	Watering days							Watering cycles							
			Mo	Tu	We	Th	Fr	Sa	So	24h	2nd	3rd	4th	5th	6th	7th	
Prog	Start	Run Time															
1	7:30	0:30	X		X				X								
2	19:00	0:20		X				X									
3	22:30	1:10	X			X				X							
4	4:00	0:15									X						
5	-	-															
6	-	-															

5. Programming

Watering modes:

The Water Computer has 3 watering modes:

- Begin **Program-controlled watering (Prog 1 – 6)** using the programs entered (Watering begins depending on the watering start times)
 - or –
- **Watering with automatic water distributor (Prog 11)** using the GARDENA automatic water distributor (watering of up to 6 watering lines)
 - or –
- **Soil moisture sensor-controlled watering (Prog 12 – 14)** using a GARDENA Soil Moisture Sensor (watering begins when the soil moisture sensor registers dry).

5.1 Basic programming

The controller can be removed to programme the unit and programming can be done on the move. (see 4. Putting Your Water Computer into Operation “Inserting battery”).

Setting language:

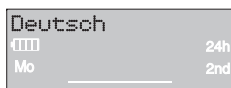

Set current time and day of week:

1. **Insert battery** (see 4. Putting Your Water Computer into Operation).
The language English flashes.
2. Set the language by turning the rotary button (**E.g.** English) and confirm by pressing **OK**.
The ticker Enter current time appears.

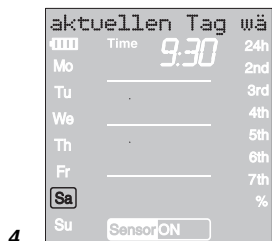
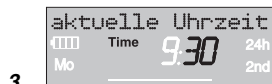

1. Press **Menu** (not necessary if the language has been set).
The ticker Enter current time appears. Time and the hour display will flash on the screen.
2. Set the time in hours with the rotary button (example: **9** hours) and confirm with the **OK**-key.
Time and the minutes display flash.
3. Set the time in minutes with the rotary button (example: **30** minutes) and confirm with the **OK**-key.
The ticker Select current day appears. Time and the day of the week display flash.
4. Set the day of the week by turning the rotary button (E.g. **Sa** Saturday) and confirm with **OK**.
The ticker Select program no. appears. Prog and the program number flash on the screen. I

Entering watering program:

Program-controlled watering (Prog 1 – 6):

Up to 6 programs can be entered using program-controlled watering (Prog 1 to 6).

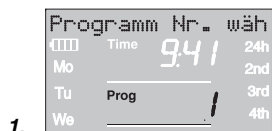

1. Press **Menu**-key twice (not necessary if the current time and day of the week has been entered).

The ticker Select program no. appears.

Prog and the program number flash on the screen.



2. Use the rotary button to set the program number (E.g. Prog 3) and confirm by pressing **OK**.

The ticker Enter watering start time appears.

Start and the hour display will flash on the screen.

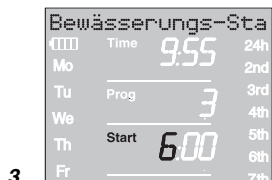

3. Set the hours for starting the watering time with the rotary button (example: 6 hours) and confirm with the **OK**-key.

Start and the minutes section flash on the display.



4. Set the minutes for starting the watering time with the rotary button (example: 20 minutes) and confirm with the **OK**-key.

The ticker Enter watering duration appears.

Run Time and the hours for the watering time flash on the display.

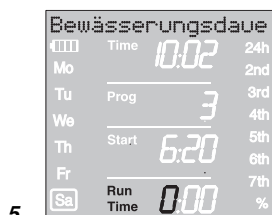

5. Set the hours for the watering time with the rotary button (example: 0 hours) and confirm with the **OK**-key.

Run Time and minutes for the watering time flash on the display.

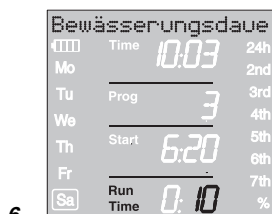

6. Set watering time minutes with the rotary button (example: 10 minutes) and confirm with the **OK**-key.

The ticker Enter watering frequency appears.

Watering cycle  24h flashes on the display.

The watering frequency can be selected by:

- the **(7.) watering cycle** (right hand column of the display)
– or –
- the **(8.) watering days** (left hand column of the display).

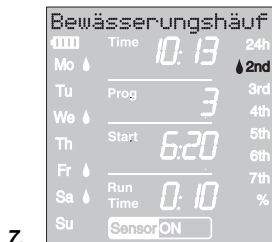

7. Select **watering cycle** with the rotary button (E.g. **2nd**) and confirm by pressing **OK**.

24h / 2nd / 3rd / 4th / 5th / 6th / 7th :

Watering every 24 hours / every 2. / 3. / 4. / 5. / 6. / 7. days

The week preview is displayed in the left hand column for 2 seconds.

The ticker Select program no. appears and the display jumps back to Step 2 and the next program number up flashes.

– or –

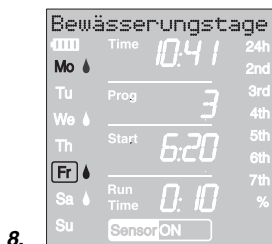

8. Select **each watering day** with the rotary button (E.g. **Mo**, **Fr** Monday and Friday) and confirm by pressing **OK**.

The ticker Enter watering days appears.

9. Press the **Menu** button

The ticker Select Program no. appears.

The display jumps back to Step 2 and the next program number up flashes.

If program number **6** has been created the ticker **Watering programs ON** is displayed.

Prog ON flash on the display.

If not all 6 programs are to be entered you can use the menu button to switch to the “Start watering programs” display level.

Starting watering programs:

The **Prog ON** must be selected so that the watering programs can start. If **Prog OFF** is selected the watering programs do not run.



1. Press **Menu** 3 times (not necessary if the program has already been created with program number **6**).

2. Select the **Prog ON** with the rotary button and confirm by pressing **OK**.

The ticker Programm OK is displayed for 2 seconds and then the display jumps to the normal display.

The Water Computer has now been programmed, i.e. the inbuilt valve opens and closes completely automatically and thus waters at the programmed times.

Even if the **Prog OFF** is selected watering can be done manually.

**Budget function /
% run time (Prog 10):**

5.2 Special programs

The programmed watering durations of the 6 watering programs can be reduced centrally in 10% steps from 100% down to 10% without changing the 6 programs. E.g. watering durations in Autumn must be shorter than in Summer.



1. Keep **Menu** button pressed for 5 seconds. (with **Prog 11** "Automatic water distributor", press **Menu** button twice).

Prog and the program number flash on the screen.

The ticker Change watering time percentage is displayed.

2. Select program number **10** by turning the knob and confirm with **OK**.

The % steps flash on the display.

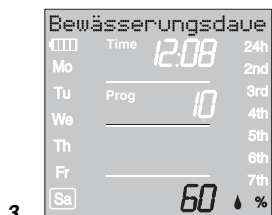

3. Turn the knob to select the required programmed watering duration percentages (E.g. **60** %) and confirm with **OK**.

The % symbol is displayed in the normal display.

Note: When the percentage of the watering duration is changed the display of the originally programmed watering durations in the 6 programs stays as it is.

Watering with automatic water distributor (Prog 11)

Automatic Water Distributor:

By connecting the GARDENA Automatic Water Distributor, **Art. 1198**, up to 6 watering lines can be controlled with the water computer. Each of the 6 watering lines can only be controlled max. once a day.

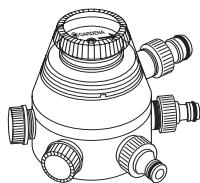

This is ideal if there is not a sufficient amount of water to operate several watering lines all at once or if individual plants require different amounts of water. Enables all watering lines to be operated one after the other.

After **Prog 11** has been confirmed with **OK** and the watering start time for the first program has been entered (see 5. Programming), all watering start times of the following 5 programs are automatically preprogrammed. Thus only the watering durations for programs 2 – 6 can be set.

To ensure that the automatic water distributor switches over properly, there must be at least a 30 minute break between each of the 6 programs.

Preprogramming **Prog 11** takes into account the minimum required 30 minute breaks between the programs and a minimum watering duration of 30 seconds (display 1 Min.). This watering duration is necessary so that the automatic water distributor switches over to the next outlet and the watering programs are allocated correctly to the corresponding watering lines.

The watering frequency entered for the first watering program applies by design to watering programs 2 – 6 too.



1. Hold the **Menu** button down for 5 seconds.
Prog and the program number flash on the screen.
2. Select program no. **11** with the knob and confirm with **OK**.
The ticker Enter watering start time appears.
Start and the hour display will flash on the screen.

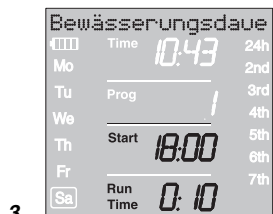

3. Set the watering start time (E.g. **18.00**) and watering duration. (E.g. **0:10**) for program 1 (**Prog 1**) (see “Set watering program” from Step 3).
4. Set the watering duration for programs **2 – 6**.

Prog OFF and Prog 11:

If after confirming **Prog 11** the watering programs are turned off (**Prog OFF**) or the watering duration (run time) is set to 0, all programs starting at this time are reduced to the minimum watering duration of 30 seconds. (Display: 1 min.). Thus the watering programs are allocated correctly to the corresponding outlet of the automatic water distributor.

By opening the water flow for a short time the outlets on the automatic water distributor are switched on so that when the programs are switched on again (**Prog ON**) or if a watering duration is entered, the outlets to the required watering program are allocated as they were originally.

Soil moisture sensor/ rain sensor and Prog 11:

If **Prog 11** is selected and the soil moisture or rain sensor registers sufficient moisture (Sensor **OFF**), a running watering program is stopped. The time of the following waterings are reduced to 30 seconds. (Display: 1 min.) until the soil moisture or rain sensor allows watering again. Then the originally entered watering duration is run again.

Reducing watering because the soil moisture is sufficient ensures that the automatic water distributor switches to the next outlet and thus the watering programs are allocated correctly to the relevant distributor outlet.

Exit watering with automatic water distributor again:

- Hold the **Menu** button down for 5 seconds.
The normal display appears on the screen again.

Soil moisture sensor-controlled watering (Prog 12 – 14):

Condition: the GARDENA Soil Moisture Sensor Art. 1188 is connected (siehe 4. Inbetriebnahme).

The previously set programs for program-controlled watering (Prog 1 to 5) are retained but they do not run.

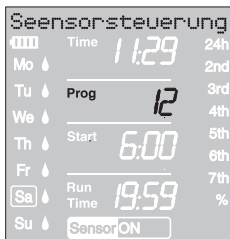

2.

1. Hold the **Menu** button down for 5 seconds.

Prog and the **program number** flash on the screen.

2. Select the required watering cycle by turning the knob (e.g. **Prog 12**) and confirm by pressing **OK**.

Prog 12 Watering throughout the day (6 a.m. – 8 p.m.) if the soil moisture sensor registers dry.

Prog 13 Watering during the night (8 p.m. – 6 a.m.) when the soil moisture sensor registers dry.

Prog 14 Watering when the soil moisture sensor registers dry.

Run Time and the **watering duration minutes** flash on the screen.

3. Set the watering duration in minutes (0 – 59 minutes) with the rotary button (E.g. **40** minutes) and confirm by pressing **OK**.

Watering starts in the set watering cycle as soon as the soil moisture sensor registers dry (Sensor ON).

The watering duration set in the sensor-controlled watering mode also applies to manual watering.



3.

In the case of soil moisture sensor-controlled watering, a two hour watering pause is triggered after every watering cycle in order for the soil moisture sensor to record the soil moisture.

Example:

Watering cycle = ☀️ **Prog 12** (Watering throughout the day)

Watering duration = 40 minutes.

Watering begins when the sensor registers dry (Sensor ON) during the day (between 6 a.m. and 8 p.m.) and ends up to 40 minutes later depending on the amount of moisture in the soil.

The watering duration is preset to 30 minutes at the factory.

Emergency programme:

If no sensor is inserted in sensor-controlled watering mode or if the connection cable is faulty, watering will take place every 24 hours. The watering duration depends on the run time but is limited to a maximum of 30 minutes.

→ Hold the **Menu** button down for 5 seconds.

The normal display appears on the screen again.

Exit soil moisture sensor-controlled watering again:

5.3 Other settings:

Read / modify watering programmes:

If a value in the programme is to be changed, this can be changed without changing the other values in the programme.

1. Press the **Menu** key twice.
Start and the hours flash on the display.
2. Press the **Menu** button to jump to the next programme level
– or –
change the programme data with the rotary button and confirm by pressing the **OK** button.

If the watering period is changed while a programme is running, the current watering is ended.

Manual operation:

The valve can be **opened or closed manually at any time**. A program-controlled open valve can also be closed early without changing the program data (Watering start time, watering duration and watering frequency). The controller must be fitted.

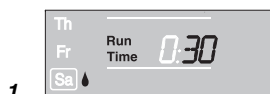

1. Press **Man.**-key to open the valve manually (or to close an open valve).
Run Time and the watering time in minutes (set to 30 minutes in the works) flash for 10 seconds on the display.

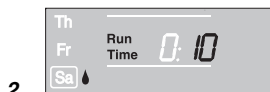

2. Whilst the watering time in minutes is flashing, the watering duration can be modified with the rotary button (between **0:00** and **0:59**) (example: **10** minutes) and confirm by pressing the **OK** button.
3. Press **Man.**-key to close the valve early.
The valve is closed.

The amended manual opening period is stored, i.e. each time the valve is opened manually in future the modified opening period is preset. If the manual opening period is amended to **0:00**, the valve is closed and also remains closed after the **Man.**-key is pressed (child lock).

If the valve has been opened manually and a programmed start of a watering period overlaps the manual opening period, the programmed starting time is suppressed.

Example:

The valve is **opened at 9.00 a.m. manually**, the opening period is 30 minutes. A program with a **start time (START) between 9.00 and 9.30 a.m.** will not be undertaken in this case.

Reset:

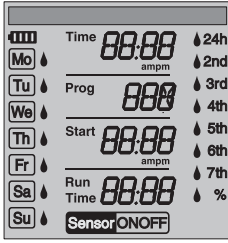

The factory settings are restored.

→ Press **Man.**-key and **Menu**-key simultaneously for 3 seconds.
All the LCD symbols are displayed for 2 seconds and the display moves to the normal display.

- All the program data are set to zero.
- The manual watering period is set to **0:30** again.
- The language, the time and the day of the week are retained.

Important information:

If no entry is made during programming for a period of more than 60 seconds, the normal display reappears. In this case all changes made up till now will be applied.

When a sensor installed in the Water Computer registers damp (**OFF**), the programmed watering is not carried out. There must be a 1 minute pause between programs.

6. Putting Your Water Computer out of Operation

Storage / Overwintering:



1. Press **Menu**-key 3 times, select **Prog OFF** with the rotary button and confirm with the **OK**-key.
The watering program is not run.
2. Store your Water Computer in a dry place where it is protected from frost.

Disposal:
 (in accordance with RL 2002/96/EC)



The product must not be added to normal household waste. It must be disposed of in line with local environmental regulations.
 → Important: Make sure that the unit is disposed of via your municipal recycling collection centre.

Disposing of flat batteries:

→ Please return flat batteries to a GARDENA dealer or dispose of them properly at your nearest recycling centre.
 Only dispose of batteries when they are **flat**.

7. Maintenance

Clean filter:

The filter ⑳ should be checked regularly and cleaned when necessary.

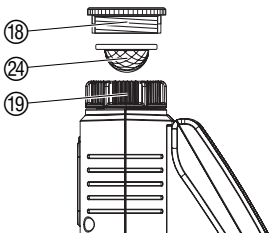

1. Unscrew sleeve nut ⑱ of the Water Computer by hand from the tap thread (do not use pliers).
2. If necessary unscrew the adaptor ⑱.
3. Remove filter ⑳ from sleeve nut ⑱ and clean.
4. Fit the Water Computer again (see 4. Putting Your Water Computer into Operation "Connecting Water Computer").

8. Troubleshooting

Fault	Possible Cause	Remedy
No display appears	Battery inserted incorrectly.	→ Check polarity markings match (+/-).
	Flat battery.	→ Insert new (alkaline) battery.
	Temperature on the display is higher than 60 °C.	Display appears after temperature has dropped.
Manual watering is not possible using the Man. button	Battery flat (1 bar flashes).	→ Insert new (alkaline) battery.
	Manual watering period is set to 0:00 .	→ Set manual watering period to a figure greater than 0:00 (see 5. Programming).
	Tap turned off.	→ Turn tap on.
Watering program is not being undertaken (no watering)	Watering program has not been entered completely.	→ Read off watering program and modify if necessary.
	Programs deactivated (Prog OFF).	→ Activate program (Prog ON).
	Program entry/modification during or just before the start pulse.	→ Make program entry/modification outside the programmed start times.
	Valve was opened manually previously.	→ Avoid possible program overlaps.
	Tap turned off.	→ Turn tap on.
	Program overlap (1 st watering start time has priority).	→ Enter new watering program without overlaps.
	Soil moisture or rain sensor registers damp (sensor OFF).	→ If dry, check setting/location of soil moisture/rain sensor.
Battery flat (1 bar flashing).	→ Insert new (alkaline) battery.	
Water Computer does not close	Minimum quantity of water drawn is less than 20 l/h.	→ Connect more drip heads.
Display: Sensor fault	Sensor not correctly connected.	→ Check connection cable and sensor.



In the event of other faults please contact GARDENA Service.
Repairs should only be carried out by GARDENA service centres or dealers authorised by GARDENA.

9. Available accessories

GARDENA
Soil Moisture Sensor

Art. No. 1188

GARDENA
Rain Sensor electronic

Art. No. 1189

GARDENA
Anti-theft device

Art. No. 1815-00.791.00
From GARDENA Service

GARDENA Adapter cable	(to connect older GARDENA sensors)	Art. No. 1189-00.600.45 From GARDENA Service
GARDENA Cable Adapter	For simultaneous connection of rain and soil moisture sensor	Art. No. 1189-00.630.00 From GARDENA Service
GARDENA Automatic Water Distributor	For fully controll of up to 6 watering lines	Art. No. 1198

10. Technical Data

Min./max. operating pressure:	0.5 bar / 12 bar
Flow medium:	Clear fresh water
Max. liquid temperature:	40 °C
Number of program-controlled watering cycles per day:	Up to 6
Watering duration per program:	1 min. to 9 hours 59 min.
Battery required:	1 × 9V alkaline manganese (alkaline) battery type IEC 6LR61
Operating time of the battery:	approx. 1 year

11. Service / Warranty

GARDENA guarantees this product for 2 years (from date of purchase). This guarantee covers all serious defects of the unit that can be proved to be material or manufacturing faults.

Under warranty we will either replace the unit or repair it free of charge if the following conditions apply:

- The unit must have been handled properly and in keeping with the requirements of the operating instructions.
- Neither the purchaser or a non-authorised third party have attempted to repair the unit.
- Faults which occur as a result of incorrectly installed or leaking batteries are not covered by the guarantee.
- Damage caused by frost is not covered by the warranty.

This manufacturer's guarantee does not affect the user's existing warranty claims against the dealer/seller.

If you have any problems with your Water Computer, please contact our Customer Service or return the defective unit together with a short description of the problem directly to one of the GARDENA Service Centres listed on the back of this leaflet.

GB <i>Product Liability</i>	<p>We expressly point out that, in accordance with product liability law, we are not liable for any damage caused by our units if it is due to improper repair or if parts exchanged are not original GARDENA parts or parts approved by us, and, if the repairs were not carried out by a GARDENA Service Centre or an authorised specialist. The same applies to spare parts and accessories.</p>
F <i>Responsabilité</i>	<p>Nous vous signalons expressément que GARDENA n'est pas responsable des dommages causés par ses appareils, dans la mesure où ces dommages seraient causés suite à une réparation non conforme, dans la mesure où, lors d'un échange de pièces, les pièces d'origine GARDENA n'auraient pas été utilisées, ou si la réparation n'a pas été effectuée par le Service Après-Vente GARDENA ou l'un des Centres SAV agréés GARDENA. Ceci est également valable pour tout ajout de pièces et d'accessoires autres que ceux préconisés par GARDENA.</p>
NL <i>Productaansprakelijkheid</i>	<p>Wij wijzen er nadrukkelijk op, dat wij op grond van de wet aansprakelijkheid voor producten niet aansprakelijk zijn voor schade ontstaan door onze apparaten, indien deze door onvakkundige reparatie veroorzaakt zijn, of er bij het uitwisselen van onderdelen geen gebruik gemaakt werd van onze originele GARDENA onderdelen of door ons vrijgegeven onderdelen en de reparatie niet door de GARDENA technische dienst of de bevoegde vakman uitgevoerd werd. Ditzelfde geldt voor extra-onderdelen en accessoires.</p>
S <i>Produktansvar</i>	<p>Tillverkaren är inte ansvarig för skada som orsakats av produkten om skadan beror på att produkten har reparerats felaktigt eller om, vid reparation eller utbyte, andra än Original GARDENA reservdelar har använts. Samma sak gäller för kompletteringsdelar och tillbehör.</p>
DK <i>Produktansvar</i>	<p>Vi gør udtrykkeligt opmærksom på at i henhold til produktansvarsloven er vi ikke ansvarlige for skader forårsaget af vores udstyr, hvis det skyldes uautoriserede reparationer eller hvis dele er skiftet ud og der ikke er anvendt originale GARDENA dele eller dele godkendt af os, eller hvis reparationerne ikke er udført af GARDENA-service eller en autoriseret fagmand. Det samme gælder for ekstra udstyr og tilbehør.</p>
RUS <i>Ответственность за продукцию</i>	<p>Мы однозначно заявляем, что согласно Закону об ответственности за продукцию мы не несем ответственности за нанесенный нашим устройством ущерб, если он обусловлен неквалифицированным ремонтом или заменой деталей на запасные детали неоригинального происхождения GARDENA или неразрешенные нами детали или, если ремонт был произведен не службой сервиса GARDENA или неуполномоченным нами квалифицированным специалистом. Аналогичное относится также к дополнительным деталям и принадлежностям.</p>

<p>GB EU Certificate of Conformity</p> <p>The undersigned GARDENA International GmbH, Hans-Lorenser-Str. 40, D-89079 Ulm, hereby certifies that, when leaving our factory, the units indicated below are in accordance with the harmonised EU guidelines, EU standards of safety and product specific standards. This certificate becomes void if the units are modified without our approval.</p>	<p>Description of the unit: Water Computer Désignation du matériel : Programmeur d'arrosage Omschrijving van het apparaat : Besproeiingscomputer Produktbeskrivning: Bevattningscomputer Beskrivelse af enhederne : Vandingscomputer Название устройства : Компьютер для полива</p>
<p>F Certificat de conformité aux directives européennes</p> <p>Le constructeur, soussigné : GARDENA Manufacturing GmbH, Hans-Lorenser-Str. 40, D-89079 Ulm, déclare qu'à la sortie de ses usines le matériel neuf désigné ci-dessous était conforme aux prescriptions des directives européennes énoncées ci-après et conforme aux règles de sécurité et autres règles qui lui sont applicables dans le cadre de l'Union européenne. Toute modification portée sur ce produit sans l'accord express de GARDENA supprime la validité de ce certificat.</p>	<p>Type : Type : Typ : C 1060 plus Typ : Type : Тип :</p> <p>Art. No. : Référence : Art. nr. : 1864 Art. nr. : Varenr. : Арт. № :</p>
<p>NL EU-overeenstemmingsverklaring</p> <p>Ondergetekende GARDENA Manufacturing GmbH, Hans-Lorenser-Str. 40, D-89079 Ulm, bevestigt, dat het volgende genoemde apparaat in de door ons in de handel gebrachte uitvoering voldoet aan de eis van, en in overeenstemming is met de EU-richtlijnen, de EU-veiligheidsstandaard en de voor het product specifieke standaard. Bij een niet met ons afgestemde verandering aan het apparaat verliest deze verklaring haar geldigheid.</p>	<p>EU directives : Directives européennes : 2004/108/EC EU-richtlijnen : EU direktiv : 93/68/EC EU Retningslinier : Директивы ЕС :</p>
<p>S EU Tillverkarintyg</p> <p>Undertecknad firma GARDENA International GmbH, Hans-Lorenser-Str. 40, D-89079 Ulm, intygar härmed att nedan nämnda produkter överensstämmer med EU:s direktiv, EU:s säkerhetsstandard och produktspecifikation. Detta intyg upphör att gälla om produkten ändras utan vårt tillstånd.</p>	<p>Year of CE marking : Date d'apposition du marquage CE : Installatiejaar van de CE-aanduiding : 2007 CE-Märkningsår : CE-Märkningsår : Год разрешения маркировки знаком CE :</p>
<p>DK EU Overensstemmelse certificat</p> <p>Undertegnede GARDENA International GmbH, Hans-Lorenser-Str. 40, D-89079 Ulm bekræfter hermed, at enheder listet herunder, ved afsendelse fra fabrikken, er i overensstemmelse med harmoniserede EU retningslinier, EU sikkerhedsstandarder og produktspecifikationsstandarder. Dette certifikat træder ud af kraft hvis enhederne er ændret uden vor godkendelse.</p>	<p>Ulm, 01.08.2007 Fait à Ulm, le 01.08.2007 Ulm, 01-08-2007 Ulm, 2007.08.01. Ulm, 01.08.2007 Ульм, 01.08.2007</p> <p>Authorised representative Représentant légal Gemachtigde Behörig Firmatecknare Teknisk direktor Уполномоченный представитель</p>
<p>RUS Свидетельство о соответствии ЕС</p> <p>Мы, нижеподписавшиеся GARDENA Manufacturing GmbH, Hans-Lorenser-Str. 40, D-89079 Ulm, настоящим подтверждаем, что нижеуказанное устройство, отгруженное с нашего предприятия, имеет исполнение, соответствующее требованиям согласованных директив ЕС, стандартам по технике безопасности ЕС и производственным стандартам. При несогласованном с нами изменении устройства настоящее свидетельство теряет силу.</p>	<p> Peter Lameli Vice President</p>

Deutschland / Germany

GARDENA
Manufacturing GmbH
Service Center
Hans-Lorenser-Straße 40
D-89079 Ulm
Produktfragen:
(+49) 731 490-123
Reparaturen:
(+49) 731 490-290
service@gardena.com

Argentina

Argensem® S.A.
Calle Colonia Japonesa s/n
(1625) Loma Verde
Escobar, Buenos Aires
Phone: (+54) 34 88 49 40 40
info@argensem.com.ar

Australia

Nylex Consumer Products
50-70 Stanley Drive
Somerton, Victoria, 3062
Phone: (+61) 1800 658 276
spare.parts@nylex.com.au

Austria / Österreich

GARDENA
Österreich Ges.m.b.H.
Stettnerweg 11-15
2100 Korneuburg
Tel.: (+43) 22 62 7 45 45 36
kundendienst@gardena.at

Belgium

GARDENA Belgium NV/SA
Sterrebeekstraat 163
1930 Zaventem
Phone: (+32) 2 7 20 92 12
Mail: info@gardena.be

Brazil

Palash Comércio e
Importação Ltda.
Rua São João do Araguaia,
338 – Jardim Califórnia –
Barueri – SP – Brasil –
CEP 06409-060
Phone: (+55) 11 4198-9777
eduardo@palash.com.br

Bulgaria

Хускварна България ЕООД
1799 София
Бул. „Андрей Ляпчев“ № 72
Тел.: 02/ 8755148, 9753076
www.husqvarna.bg

Canada

GARDENA Canada Ltd.
100 Summerlea Road
Brampton, Ontario L6T 4X3
Phone: (+1) 905 792 9330
info@gardenacanada.com

Chile

Antonio Martinic y Cia Ltda.
Cassillas 272
Centro de Cassillas
Santiago de Chile
Phone: (+56) 2 20 10 708
garfar_cl@yahoo.com

Costa Rica

Compania Exim
Euroberoamericana S.A.
Los Colegios, Moravia,
200 metros al Sur del Colegio
Saint Francis - San José
Phone: (+506) 297 68 83
exim_euro@racsa.co.cr

Croatia

KLIS d.o.o.
Stanciceva 79
10419 Vukovina
Phone: (+385) 1 622 777 0
gardena@klis-trgovina.hr

Cyprus

FARMOKIPIKI LTD
P.O. Box 7098
74, Digeni Akritia Ave.
1641 Nicosia
Phone: (+357) 2275 47 62
condam@spidernet.com.cy

Czech Republic

GARDENA spol. s r.o.
Tuřanka 115
627 00 Brno
Phone: (+420) 800 100 425
gardena@gardenabrno.cz

Denmark

GARDENA Norden AB
Salgsafdeling Danmark
Box 9003
S-200 39 Malmö
info@gardena.dk

Finland

Oy Husqvarna Ab
Lautatarhankatu 8b/ PL 3
FI-00581 HELSINKI

France

GARDENA
PARIS NORD 2
69, rue de la Belle Etoile
BP 57080
ROISSY EN FRANCE
95948 ROISSY CDG CEDEX
Tél. (+33) 0826 101 455
service.consommateurs@
gardena.fr

Great Britain

Husqvarna UK Ltd
Preston Road
Aycliffe Industrial Park
Newton Aycliffe
County Durham
DL5 6UP
info.gardena@husqvarna.co.uk

Greece

Agrokip
Psoomadopoulos S.A.
Ifaistou 33A
Industrial Area Koropi
194 00 Athens Greece
V.A.T. EL093474846
Phone: (+30) 210 6620 225
service@agrokip.gr

Hungary

GARDENA
Magyarország Kft.
Késmárk utca 22
1158 Budapest
Phone: (+36) 80 20 40 33
gardena@gardena.hu

Iceland

Ó. Johnson & Kaaber
Tunguhalsi 1
110 Reykjavik
ooj@ojk.is

Ireland

Michael McLoughlin & Sons
Hardware Limited
Long Mile Road
Dublin 12

Italy

GARDENA Italia S.p.A.
Via Donizetti 22
20020 Lainate (Mi)
Phone: (+39) 02.93.94.79.1
info@gardenaitalia.it

Japan

KAKUICHI Co. Ltd.
Sumitomo Realty &
Development Kojimachi
BLDG., 8F
5-1 Nibanncyo, Chiyoda-ku
Tokyo 102-0084
Phone: (+81) 33 264 4721
m_ishihara@kaku-ichi.co.jp

Luxembourg

Magasins Jules Neuberg
39, rue Jacques Stas
Luxembourg-Gasperich 2549
Case Postale No. 12
Luxembourg 2010
Phone: (+352) 40 14 01
api@neuberg.lu

Netherlands

GARDENA Nederland B.V.
Postbus 50176
1305 AD ALMERE
Phone: (+31) 36 521 00 00
info@gardena.nl

Neth. Antilles

Jonka Enterprises N.V.
Sta. Rosa Weg 196
P.O. Box 8200, Curaçao
Phone: (+599) 9 767 66 55
pgm@jonka.com

New Zealand

NYLEX New Zealand Limited
Building 2, 118 Savill Drive
Mangere, Auckland
Phone: (+64) 0800 22 00 88
spare.parts@nylex.com.au

Norway

GARDENA Norden AB
Salgskontor Norge
Kleverveien 6
1540 Vestby
info@gardena.no

Poland

GARDENA Polska Sp. z o.o.
Szymanów 9 d
05-532 Baniocza
Phone: (+48) 22 727 56 90
gardena@gardena.pl

Portugal

GARDENA Portugal Lda.
Recta da Granja do Marquês
Edif. GARDENA Algueirão
2725-596 Mem Martins
Phone: (+351) 21 922 85 30
info@gardena.pt

Romania

MADEX INTERNATIONAL SRL
Soseaua Odaii 117-123,
Sector 1,
București, RO 013603
Phone: (+40) 21 352 76 03
madex@ines.ro

Russia / Россия

ООО ГАРДЕНА РУС
123007, г. Москва
Хорошевское шоссе, д. 32А
Тел.: (+7) 495 540 99 57
info@gardena-rus.ru

Singapore

Hy-Ray PRIVATE LIMITED
40 Jalan Pemimpin
#02-08 Tat Ann Building
Singapore 577185
Phone: (+65) 6253 2277
hyray@singnet.com.sg

Slovak Republic

GARDENA Slovensko, s.r.o.
Panónska cesta 17
851 04 Bratislava
Phone: (+421) 263 453 722
info@gardena.sk

Slovenia

GARDENA d.o.o.
Brodšče 15
1236 Trzin
Phone: (+386) 1 580 93 32
servis@gardena.si

South Africa

GARDENA
South Africa (Pty.) Ltd.
P.O. Box 11534
Vorna Valley 1686
Phone: (+27) 11 315 02 23
sales@gardena.co.za

Spain

GARDENA IBÉRICA S.L.U.
C/ Basauri, nº 6
La Florida
28023 Madrid
Phone: (+34) 91 708 05 00
atencioncliente@gardena.es

Sweden

GARDENA Norden AB
Försäljningskontor Sverige
Box 9003
200 39 Malmö
info@gardena.se

Switzerland / Schweiz

GARDENA (Schweiz) AG
Bitzberg 1
8184 Bächenbülach
Phone: (+41) 848 800 464
info@gardena.ch

Turkey

GARDENA / Dost Diş Ticaret
Mümesillik A.Ş. Sanayi
Çad. Adil Sokak No. 1
Kartal - İstanbul
Phone: (+90) 216 38 93 939
info@gardena-dost.com.tr

Ukraine / Україна

ALTSEST JSC
4 Petropavlivska Street
Petropavlivska
Borschahivka Town
Kyivo Svyatoshyyn Region
08130, Ukraine
Phone: (+380) 44 459 57 03
uprr@altsest.kiev.ua

USA

Melnor Inc.
3085 Shawnee Drive
Winchester, VA 22604
Phone: (+1) 540 722-9080
service_us@melnor.com

1864-28.960.01/0108
© GARDENA
Manufacturing GmbH
D-89070 Ulm
http://www.gardena.com