

10000 SL Inox Art. 1784

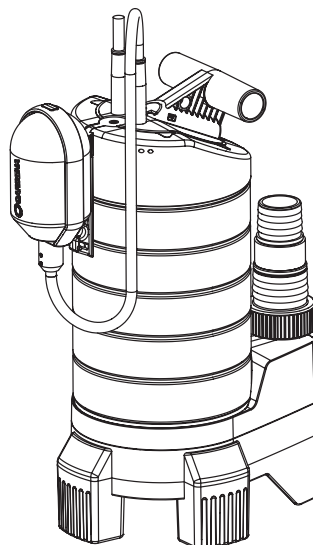

18000 SP Inox Art. 1798

D Betriebsanleitung

Tauchpumpe / Schmutzwasserpumpe

GB Operating Instructions

Submersible Pump / Dirty Water Pump

F Mode d'emploi

Pompe d'évacuation pour eaux claires /
Pompe d'évacuation pour eaux chargées

NL Instructies voor gebruik

Dompelpomp / Vuilwaterpomp

S Bruksanvisning

Dränkbar pump / Spillvattenpump

I Istruzioni per l'uso

Pompa sommersa / Pompa sommersa per acqua sporca

E Manual de instrucciones

Bomba sumergible / Bomba para aguas sucias

P Instruções de utilização

Bomba submersível / Bomba para águas sujas

DK Brugsanvisning

Dykpumpe / Dykpumpe til urent vand

GARDENA

Submersible Pump 10000 SL Inox

Dirty Water Pump 18000 SP Inox

Welcome to the garden of GARDENA ...



Translation of the original instructions from German. Please read these operating instructions carefully and observe the notes given. Use the instructions to familiarise yourself with the pump, its correct use, and the notes on safety.



For safety reasons, children under 16 as well as persons not familiar with these operating instructions should not use this pump.

→ Keep these operating instructions in a safe place.

Contents

1. Applications Range of Your GARDENA Pump	12
2. For Your Safety	13
3. Initial Operation	14
4. Operation	15
5. Cleaning	17
6. Trouble-Shooting	17
7. Storage	18
8. Technical Data	18
9. Service	19

1. Applications Range of Your GARDENA Pump

Intended use

GARDENA Pumps have been designed for private use around your house and garden. They are predominantly destined for drainage after flooding, transfer of liquids, draining containers, taking water from wells and shafts, draining boats and yachts as well as for water aeration and circulation for a limited period of time.

Liquids to be pumped

Liquids which can be handled by the GARDENA Pump are the following: clean and contaminated water (max. particle size 10000 SL Inox = 5 mm / 18000 SP Inox = 38 mm), swimming pool water (prerequisite is the recommended dosage of additives) and soapy water.

The pumps are fully submersible (waterproof sealed) and can be immersed in the liquid down to a depth of 9 m.

Please note



The GARDENA Pumps are not designed for continuous operation (e.g. continuous circulating operation) in a pond. Your pump's life will be shortened correspondingly by such operation.

Corrosive, easily combustible or explosive substances (e.g. gasoline, petroleum, nitro thinner), fats, oils, salt-water and waste water of toilets and urinals must not be pumped. The temperature of the liquid handled should not exceed 35 °C.

2. For Your Safety

Residual-current device

According to DIN VDE (German Electrical Engineers' Association) 0100, submersible pumps and dirty water pumps may only be used in swimming pools, garden ponds, and fountains if the pump is operated via a residual-current device with a residual-current rating of ≤ 30 mA. The pump must not be operated when there are persons in the swimming pool or garden pond. For safety reasons we recommend that you always operate the pump via a residual-current device (DIN VDE 0100-702 and 0100-738).

→ Please contact your electrician.

In Austria

In Austria, according to ÖVE B/EN 60 555 part 1 to 3, pumps which are used in swimming pools and garden ponds, and equipped with firm power cable should be fed via an ÖVE approved isolating transformer – rated voltage must not exceed 230 V.

In Switzerland

In Switzerland mobile appliances which are used outdoors, must be connected via a residual-current device.

Mains power

According to DIN VDE (German Electrical Engineers' Association) 0620, mains power cables must not have a smaller cross-section than the rubber-sheathed cables of the designation H05 RNF (model 10000 SL Inox) or H07 RNF (model 18000 SP Inox). The cable length must be at least 10 m.

Data indicated on the type plate must match technical data of the mains supply.

→ Take care that the electrical connections are made within dry area, protected from flooding.

Protect plug and power cable from heat, oil and sharp edges.

→ Don't use the power cable for plugging off.

The power cable or the float switch must not be used for mounting or relocating the pump. For submerging or lifting/securing the pump, fix a rope to the pump's carrying handle.

Extension cables must meet the requirements of DIN VDE 0620.

Visual check

→ Before operating the pump, first make a visual check, if there is any damage of the pump (esp. regarding power cable and plug).

→ Observe the minimum water level and the max. delivery height (see 8. Technical Data).

A damaged pump must not be used.

→ In case of damage, please have the pump checked by our GARDENA Service Centre.

Manual operation

During manual operation, the pump must be switched off as soon as all the liquid has been pumped away.

→ Observe the pump at all times during manual operation.

Notes on use

Dry-running operation causes increased wear and is to be avoided. Therefore, in manual operation the pump must be immediately unplugged when water fails to flow.

Avoid running of the pump for more than 10 min. against closed delivery side of the pump.

**Note on
10000 SL Inox**

Thermal motor protector

Automatic deaerating valve

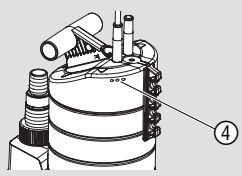

Sand and other abrasive substances cause increased wear and reduce the pump's output.
Take care that the pump is located where the inlet openings at the suction base are obstructed neither completely nor partly.
Stand the pump on a brick if using in a pond.

When you purchase your pump the swivel feet are set to the **flat suction position** (1 mm).
→ For normal operation, turn the feet 180° to 5 mm.
The pump is lifted 5 mm.
→ Clear the outlet line before use.

The pump is automatically switched off on overheating by the built-in thermal motor protector. After having cooled down, the motor automatically switches on again (see 6. Trouble Shooting).

The automatic deaerating valve eliminates any air pockets in the pump. Air escapes by the vent bores ④ and air bubbles form under water. This is not a defect of your pump, but serves to deaerate the pump.
It may take several seconds for the air to escape when the pump is immersed for the first time.

3. Initial Operation

Hose diameter for 10000 SL Inox:	13 mm (1/2") 15 mm (5/8") 19 mm (3/4")	25 mm (1")	38 mm (1 1/2")
---	--	------------	----------------

Hose diameter for 18000 SP Inox:	–	38 mm (1 1/2")	50 mm (2")
---	---	----------------	------------

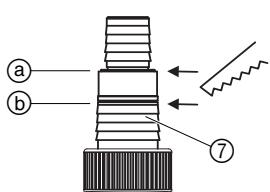

Hose connection of universal fitting ⑦

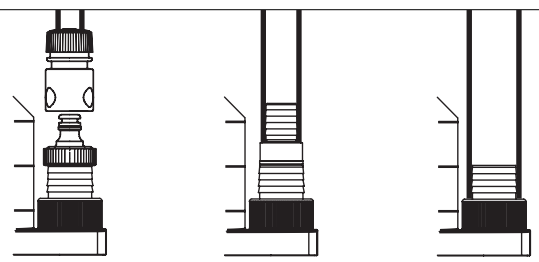

Hose connection	Cut off topmost nipple at ①.	Do not cut off any nipples.	Cut off top two nipples at ②.
------------------------	------------------------------	-----------------------------	-------------------------------

For 10000 SL Inox:

The following connection kits are required for 13 mm to 19 mm connections:

13 mm (1/2"): GARDENA Pump Connection Set, Art. No. 1750
or GARDENA Tap Connector, Art. No. (2)902,
and GARDENA Standard Hose Connector,
Art. No. (2)915

15 mm (5/8"): GARDENA Tap Connector, Art. No. (2)902,
and GARDENA Standard Hose Connector,
Art. No. (2)916

19 mm (3/4"): GARDENA Pump Connection Set, Art. No. 1752
or GARDENA Tap Connector, Art. No. 2802,
and GARDENA Standard Hose Connector,
Art. No. 2817.

Best results in delivery capacity are achieved when using 38 mm (1 1/2") hoses.

For 18000 SP Inox:

Best results in delivery capacity are achieved when using 50 mm (2") hoses.

Connecting the hose:

The universal fitting ⑦ allows you to connect all the hoses listed in the previous table.

1. Cut off nipples of the universal fitting ⑦, which are not needed, to match the hose connection.
2. Screw the universal fitting ⑦ onto the pump.
3. Connect the hose to the universal fitting ⑦.

We recommend that you secure 50 mm (2") and 38 mm (1 1/2") hoses additionally with a **GARDENA Hose Clip Art. No. 7195** (for 50 mm) and **Art. No. 7194** (for 38 mm).

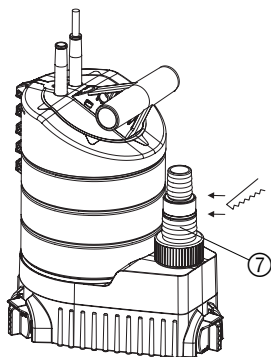

Only for 10000 SL Inox:

For flat suction we recommend using a 13 mm (1/2") or 15 mm (5/8") hose.

Only for 13 mm (1/2") hose:

The universal fitting ⑦ can also be equipped with a **GARDENA Regulator Valve Art. No. 977** so that the contents of the outlet line do not flow back through the pump after pumping. The Regulator Valve can be ordered from your GARDENA dealer.

4. Operation

Automatic operation:

The float switch ⑤ turns the pump on automatically when the water level exceeds the cut-in height and the water is pumped out.

The float switch ⑤ turns the pump off again as soon as the water level falls below the cut-out height.

1. Stand the pump on a firm surface
– or –
use a rope attached through the bore hole in the carrying handle ② to immerse the pump in a well or shaft.
During automatic operation, ensure that the float switch ⑤ can move freely.
2. Plug the power cable ① into a mains socket.

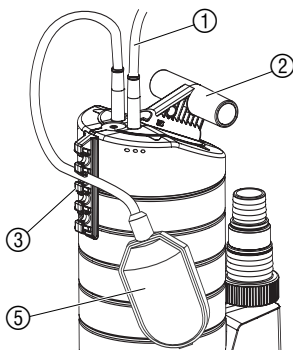

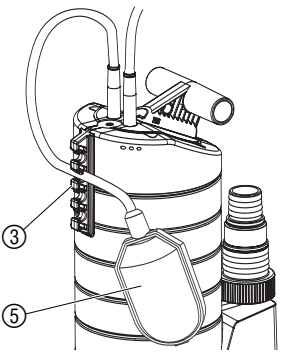

Adjusting the Cut-in and Cut-out Height:

The maximum cut-in height and minimum cut-out height (see 8. Technical Data) can be adjusted.

→ Press the cable of the float switch (5) into an opening in the float switch lock (3).

Do not select a cable length that is too long or short to ensure that the float switch can turn on and off properly.

- The higher the opening of the float switch lock (3), the higher the cut-in and cut-out height.
- The shorter the length of cable between the float switch (5) and the float switch lock (3), the lower the cut-in height and the higher the cut-out height.

The cable length between the float switch (5) and the float switch lock (3) must always be at least 10 cm.

Manual operation:

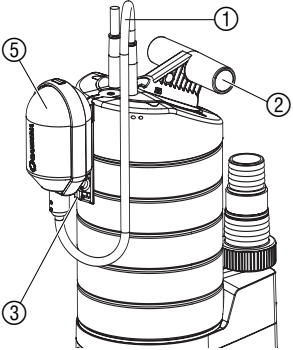

The pump remains in constant operation because the float switch is bypassed.

1. Push the float switch (5) onto the float switch lock (3) with the cable downward.
2. Stand the pump on a firm surface
– or –
use a rope attached through the bore hole in the carrying handle (2) to immerse the pump in a well or shaft.
3. Plug the power cable (1) into a mains socket.

The residual water height (approx. 1 mm for 10000 SL Inox / 40 mm for 18000 SP Inox) is only reached during manual operation since the float switch turns off the pump during automatic operation before this water level is reached.

Only for 10000 SL Inox:
Flat suction /
Normal operation

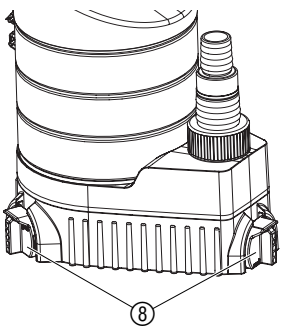

→ If the water height is lower than 3.5 cm, fill the pump before operation over the universal fitting (7) with water.

Flat suction:

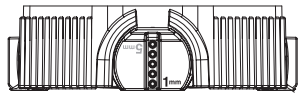

→ Turn the 3 swivel feet (8) 180° to 1 mm.
Flat suction up to 1 mm.

Normal operation:

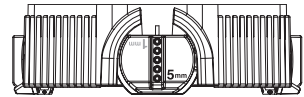

→ Turn the 3 swivel feet (8) 180° to 5 mm.
Flat suction up to 5 mm.

The residual water level of approx. 1 mm is only reached during flat suction in the manual operation mode. If the water level is lower than 25 mm, you can accelerate flat suction by switching the pump off and on 2 to 3 times.

5. Cleaning

Flushing the Pump:

Cleaning the suction base and impeller:

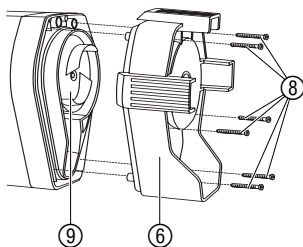
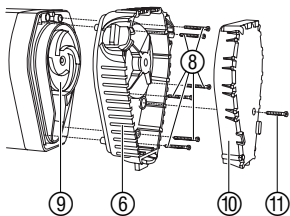

The pumps are virtually maintenance-free.

After having pumped chlorinated swimming pool water or other liquids leaving residues, the pump should be rinsed with clear water.



Warning! Electric shock!

Risk of injury due to electric shock.

→ **Disconnect the pump from the mains before cleaning the suction base and impeller.**

1. **Only for 10000 SL Inox:** Unscrew the Phillips screw ⑪ and pull the suction base cover ⑩ off the suction base ⑥.
2. Unscrew the 6 Phillips screws ⑧ and pull the suction base ⑥ off the pump.
3. Clean suction base ⑥, impeller ⑨ and suction base cover ⑩ if necessary.
4. Reinstall the suction base ⑥ and screw in the Phillips screws ⑧.
5. **Only for 10000 SL Inox:** Insert the suction base cover ⑩ into the suction base ⑥ and screw in the Phillips screw ⑪.

Note for 10000 SL Inox:

It is often sufficient to simply remove the suction base cover ⑩ and clean the suction base cover ⑩ and suction base ⑥.

For safety reasons a damaged impeller ⑨ can only be exchanged by the GARDENA Service Centre.

6. Trouble-Shooting

Problem	Probable cause	Remedy
Pump is running, but doesn't deliver.	Air cannot escape, since pressure line is closed.	→ Open pressure line (e.g. kinked pressure pipe).
	Air locks in the suction base.	→ Wait for max. 60 seconds until the pump deaerates automatically over the vent valve. If necessary, switch off and start it again.
	Impeller clogged.	→ Disconnect plug and clean impeller (see 5. Cleaning).
	When starting the pump, water height falls below the min. water level.	→ Submerge pump deeper.
Pump doesn't start or suddenly stops during operation.	Thermal overload switch has switched the pump off due to overheating.	→ Disconnect plug and clean impeller (see 5. Cleaning). Observe max. media temperature of 35 °C.

Problem	Probable cause	Remedy
Pump doesn't start or suddenly stops during operation.	No power.	→ Check fuses and electric connections.
	Dirt particles are jammed in the suction base.	→ Disconnect plug and clean suction base (see 5. Cleaning).
Pump runs, but output suddenly decreases.	Suction base is clogged.	→ Disconnect plug and clean suction base (s. 5. Cleaning).
Only for 10000 SL Inox: Pump does not reach residual water height of 1 mm during flat suction.	The suction base cover ⑩ is missing in the suction base.	→ Disconnect the plug from the mains and install the suction base cover ⑩ (see 5. Cleaning).



Attention!

Repairs on electrical parts should only be done by our GARDENA Service Centres.

If you have any problems with your Pump, please contact our Service.

7. Storing Your Pump

Frost-free storage

Store the pump away from frost before the first frost sets in.

Disposal:

(in accordance with RL2002/96/EC)



The product must not be added to normal household waste. It must be disposed of in line with local environmental regulations.

8. Technical Data

Type	Submersible Pump 10000 SL Inox (Art. 1784)	Dirty Water Pump 18000 SP Inox (Art. 1798)
Rated power	380 W	1000 W
Max. delivery capacity	10.000 l/h	18.000 l/h
Max. pressure	0.7 bar	1.0 bar
Max. delivery height	7 m	10 m
Max. submersion depth	9 m	9 m
Residual water level	1 mm	40 mm
Contaminated water with particle size of max.	5 mm	38 mm
Power cable	10 m H05 RNF	10 m H07 RNF
Pump connection	38 mm (1 1/2")- / 25 mm (1")- graduated nipple, option GARDENA Water hose Plug-in-system	50 mm (2")- / 38 mm (1 1/2")- graduated nipple
Min. water level for operation	35 mm	100 mm
Weight approx.	4.4 kg	7.1 kg

Type	Submersible Pump 10000 SL Inox (Art. 1784)	Dirty Water Pump 18000 SP Inox (Art. 1798)
Max. media temperature	35 °C	35 °C
Mains voltage/ mains frequency	230 V / 50 Hz	230 V / 50 Hz
Min. cut-in height	235 mm	340 mm
Min./max. cut-out height	30 mm / 135 mm	50 mm / 225 mm
Noise level L_{WA} ¹⁾	48 dB(A)	55 dB(A)

1) Measuring method according to EN 60335-1

Cut-in / Cut-out height

The cut-in and cut-out height varies.

Only for 10000 SL Inox:

The residual water height (flat suction down to approx. 1 mm) is only reached during manual operation with the swivel feet ③ turned to 1 mm (see 4. Operation).

Performance characteristics

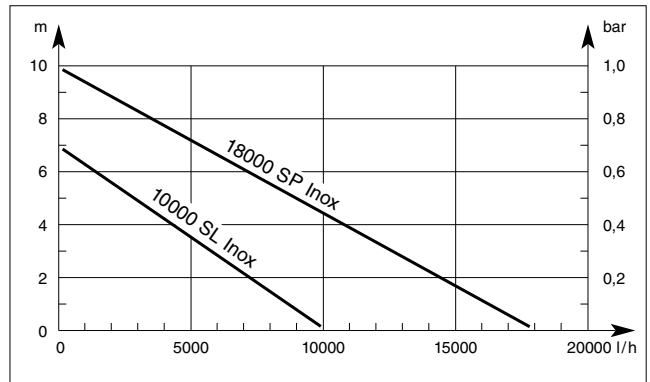

9. Service

Warranty

GARDENA guarantees this product for 2 years (from date of purchase). This guarantee covers all serious defects of the unit that can be proved to be material or manufacturing faults. Under warranty we will either replace the unit or repair it free of charge if the following conditions apply:

- The unit must have been handled properly and in keeping with the requirements of the operating instructions.
- Neither the purchaser or a non-authorized third party have attempted to repair the unit.

The impeller is a wearing part and is not covered by the guarantee.

This manufacturer's guarantee does not affect the user's existing warranty claims against the dealer/seller.

If you have any problems with your pump, please contact our Customer Service or return the defective unit together with a short description of the problem directly to one of the GARDENA Service Centres listed on the back of this leaflet.

Product Liability

We expressly point out that, in accordance with the product liability law, we are not liable for any damage caused by our units if it is due to improper repair or if parts exchanged are not original GARDENA parts or parts approved by us, and, if the repairs were not carried out by a GARDENA Service Centre or an authorised specialist. The same applies to spare parts and accessories.

EU Certificate of Conformity

The undersigned

GARDENA Manufacturing · Hans-Lorenser-Str. 40 · D-89079 Ulm

hereby certifies that, when leaving our factory, the units indicated below are in accordance with the harmonised EU guidelines, EU standards of safety and product specific standards.

This certificate becomes void if the units are modified without our approval.

Description of the units: Submersible Pump / Dirty Water Pump
Types: 10000 SL Inox / 18000 SP Inox
Art. No.: 1784 / 1798
EU directives: Machinery Directive 98/37/EC : 1998
2006/42/EC : 2006
Electromagnetic Compatibility 2004/108/EC
Low Voltage Directive 2006/95/EC
Directive 93/68/EC

Harmonised

European standards: EN 292-1
EN 292-2
EN 60335-1
EN 60335-2-41

Year of CE marking: 2002

Ulm, 04.06.2002



Thomas Heint
Technical Dept. Manager

Deutschland / Germany

GARDENA
Manufacturing GmbH
Service Center
Hans-Lorenser-Straße 40
D-89079 Ulm
Produktfragen:
(+49) 731 490-123
Reparaturen:
(+49) 731 490-290
service@gardena.com

Argentina

Argensem® S.A.
Calle Colonia Japonesa s/n
(1625) Loma Verde
Escobar, Buenos Aires
Phone: (+54) 34 88 49 40 40
info@argensem.com.ar

Australia

Nylex Consumer Products
50-70 Stanley Drive
Somerton, Victoria, 3062
Phone: (+61) 1800 658 276
spare.parts@nylex.com.au

Austria / Österreich

GARDENA
Österreich Ges.m.b.H.
Stettnerweg 11-15
2100 Korneuburg
Tel.: (+43) 22 62 7 45 45 36
kundendienst@gardena.at

Belgium

GARDENA Belgium NV/SA
Sterrebeekstraat 163
1930 Zaventem
Phone: (+32) 2 7 20 92 12
Mail: info@gardena.be

Brazil

Palash Comércio e
Importação Ltda.
Rua Américo Brasiliense,
2414 - Chácara Sto Antonio
São Paulo - SP - Brasil -
CEP 04715-005
Phone: (+55) 11 5181-0909
eduardo@palash.com.br

Bulgaria

DENEX LTD.
2 Luis Ahalier Str. - 7th floor
Sofia 1404
Phone: (+359) 2 958 18 21
office@denex-bg.com

Canada

GARDENA Canada Ltd.
100 Summerlea Road
Brampton, Ontario L6T 4X3
Phone: (+1) 905 792 93 30
info@gardenacanada.com

Chile

Antonio Martinic y Cia Ltda.
Cassillas 272
Centro de Cassillas
Santiago de Chile
Phone: (+56) 2 20 10 708
garfar_cl@yahoo.com

Costa Rica

Compania Exim
Euroberoamericana S.A.
Los Colegios, Moravia,
200 metros al Sur del Colegio
Saint Francis - San José
Phone: (+506) 297 68 83
exim_euro@racsa.co.cr

Croatia

KLIS d.o.o.
Stanciceva 79
10419 Vukovina
Phone: (+385) 1 622 777 0
gardena@klis-trgovina.hr

Cyprus

FARMOKIPIKI LTD
P.O. Box 7098
74, Digeni Akritra Ave.
1641 Nicosia
Phone: (+357) 22 75 47 62
condam@spidernet.com.cy

Czech Republic

GARDENA spol. s r.o.
Řípská 20a, č.p. 1153
627 00 Brno
Phone: (+420) 800 100 425
gardena@gardenabrno.cz

Denmark

GARDENA Norden AB
Salgsafdeling Danmark
Box 9003
S-200 39 Malmö
info@gardena.dk

Finland

Habitec Oy
Martinkyläntie 52
01720 Vantaa

France

GARDENA
PARIS NORD 2
69, rue de la Belle Etoile
BP 57080
ROISSY EN FRANCE
95948 ROISSY CDG CEDEX
Tél. (+33) 0826 101 455
service.consommateurs@
gardena.fr

Great Britain

GARDENA UK Ltd.
27-28 Brenkley Way
Bleazard Business Park
Seaton Burn
Newcastle upon Tyne
NE13 6DS
info@gardena.co.uk

Greece

Agrokrip
Psomadopoulos S.A.
Ifaistou 33A
Industrial Area Koropi
194 00 Athens Greece
V.A.T. EL093474846
Phone: (+30) 210 66 20 225
service@agrokrip.gr

Hungary

GARDENA
Magyarország Kft.
Késmárk utca 22
1158 Budapest
Phone: (+36) 80 20 40 33
gardena@gardena.hu

Iceland

Ó. Johnson & Kaaber
Tunguhalsi 1
110 Reykjavik
oaj@ojk.is

Ireland

Michael McLoughlin & Sons
Hardware Limited
Long Mile Road
Dublin 12

Italy

GARDENA Italia S.p.A.
Via Donizetti 22
20020 Lainate (Mi)
Phone: (+39) 02.93.94.79.1
info@gardenaitalia.it

Japan

KAKUICHI Co. Ltd.
Sumitomo Realty &
Development Kojimachi
BLDG., 8F
5-1 Nibannayo, Chiyoda-ku
Tokyo 102-0084
Phone: (+81) 33 264 4721
m_ishihara@kaku-ichi.co.jp

Luxembourg

Magasins Jules Neuberg
39, rue Jacques Stas
Luxembourg-Gasperich 2549
Case Postale No. 12
Luxembourg 2010
Phone: (+352) 40 14 01
api@neuberg.lu

Netherlands

GARDENA Nederland B.V.
Postbus 50176
1305 AD ALMERE
Phone: (+31) 36 521 00 00
info@gardena.nl

Neth. Antilles

Jonka Enterprises N.V.
Sta. Rosa Weg 196
P.O. Box 8200, Curaçao
Phone: (+599) 9 767 66 55
pgm@jonka.com

New Zealand

NYLEX New Zealand Limited
Building 2, 118 Savill Drive
Mangere, Auckland
Phone: (+64) 0800 22 00 88
spare.parts@nylex.com.au

Norway

GARDENA Norden AB
Salgskontor Norge
Karihaugveien 89
1086 Oslo
info@gardena.no

Poland

GARDENA Polska Sp. z o.o.
Szymanów 9 d
05-532 Baniocha
Phone: (+48) 22 727 56 90
gardena@gardena.pl

Portugal

GARDENA Portugal Lda.
Recta da Granja do Marquês
Edif. GARDENA Algueirão
2725-596 Mem Martins
Phone: (+351) 21 922 85 30
info@gardena.pt

Romania

MADEX INTERNATIONAL SRL
Soseaua Odaii 117-123,
Sector 1,
București, RO 013603
Phone: (+40) 21 352 76 03
madex@ines.ro

Russia / Россия

ООО ГАРДЕНА РУС
123007, г. Москва
Хорошевское шоссе, д. 32А
Тел.: (+7) 495 647 25 10
info@gardena-rus.ru

Singapore

Hy - Ray PRIVATE LIMITED
40 Jalan Pemimpin
#02-08 Tat Ann Building
Singapore 577185
Phone: (+65) 6253 2277
hyray@singnet.com.sg

Slovak Republic

GARDENA Slovensko, s.r.o.
Panónska cesta 17
851 04 Bratislava
Phone: (+421) 263 453 722
info@gardena.sk

Slovenia

GARDENA d.o.o.
Brodišče 15
1236 Trzin
Phone: (+386) 1 580 93 32
servis@gardena.si

South Africa

GARDENA
South Africa (Pty.) Ltd.
P.O. Box 11534
Vorna Valley 1686
Phone: (+27) 11 315 02 23
sales@gardena.co.za

Spain

GARDENA IBÉRICA S.L.U.
C/ Basauri, nº 6
La Florida
28023 Madrid
Phone: (+34) 91 708 05 00
atencioncliente@gardena.es

Sweden

GARDENA Norden AB
Försäljningskontor Sverige
Box 9003
200 39 Malmö
info@gardena.se

Switzerland / Schweiz

GARDENA (Schweiz) AG
Bitzberg 1
1814 Bachenbülach
Phone: (+41) 848 800 464
info@gardena.ch

Turkey

GARDENA / Dost Diş Ticaret
Müessesilik A.Ş. Sanayi
Çad. Adil Sokak No. 1
Kartal - İstanbul
Phone: (+90) 216 38 93 939
info@gardena-dost.com.tr

Ukraine / Украина

ALTEST JSC
4 Petropavlivska Street
Petropavlivska
Borschahivka Town
Kyivo Svyatoshyn Region
08130, Ukraine
Phone: (+380) 44 459 57 03
upryr@altsest.kiev.ua

USA

Melnor Inc.
3085 Shawnee Drive
Winchester, VA 22604
Phone: (+1) 540 722-9080
service_us@melnor.com

1784-20.960.04 / 0507

© GARDENA

Manufacturing GmbH

D-89070 Ulm

http://www.gardena.com