

Accu 60 Art. 8801
Accu 80 Art. 8803
Accu 100 Art. 8805

Accu 80 Art. 8824
Accu 100 Art. 8825

D Gebrauchsanweisung

Accu-Rasenkantenschere / Accu-Strauchschere

GB Operating Instructions

Accu Edging Shears / Accu Shrub Shears

F Mode d'emploi

Cisailles à gazon sur accu / Taille-buissons sur accu

NL Gebruiksaanwijzing

Lithiumaccu-graskantenschaar / Lithiumaccu-buxusschaar

S Bruksanvisning

freeClip Grass / freeClip Bush

I Istruzioni per l'uso

Forbici per erba a batteria / Rifilasiopei a batteria

E Manual de instrucciones

Tijeras Accu / Recortasetos sin cable

P Instruções de utilização

Tesoura com acumulador / Tesoura para arbustos com acumulador

DK Brugsanvisning

freeClip Grass / freeClip Bush

GARDENA Accu Edging Shears / Accu Shrub Shears

Welcome to the Garden of GARDENA...



Please read these operating instructions carefully and observe the information they contain. Use these operating instructions to familiarise yourself with the GARDENA Accu Shears, their proper use and the notes on safety.



For safety reasons, children under the age of 16 as well as people, who are not familiar with the operating instructions should not use these Accu Shears.

→ Please keep these instructions in a safe place.

Contents :

1. Where to use Your GARDENA Accu Shears	10
2. Safety instructions	10
3. Assembly	12
4. Initial Operation	12
5. Operating Your Accu Shears	13
6. Putting into Storage	14
7. Maintenance	14
8. Troubleshooting	15
9. Accessories	16
10. Technical Data	16
11. Service / Warranty	17

1. Where to use Your GARDENA Accu Shears

Intended Use Edging Accu Shears :

The GARDENA Edging Accu Shears have been designed for cutting the edges of lawns and small areas of grass in private gardens / hobby areas.

Intended Use Accu Shrub Shears :

The GARDENA Accu Shrub Shears are intended for cutting individual bushes, shrubs and climbing plants in private domestic and hobby gardens.

DANGER !
Risk of injury!



Due to the risk of injury, the Accu Shears with Shrub Shears Cutting Blade Art. 5378 must not be used for cutting grass / grass edges.

2. Safety instructions

→ Please read the notes on safety for your Accu Shears.



WARNING !
Please read the operating instructions before using this tool.

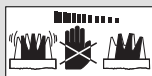

DANGER !
Cutting tool continues to run after switching off!



WARNING !
Do not use in rain or wet conditions.



WARNING !
Keep bystanders away.

Initial Operation

- Inspect these Accu Shears before every use.
 - Never disable the safety devices.
- Do not use these Shears if the safety devices and / or the blades have been damaged or are worn out.

Proper Use

- Only use the Accu Shears for the purposes specified in these instructions.

WARNING !
Personal Injury and Damage to Property !



- The Accu Shears are not intended for cutting hedges or chopping material up for composting.

Work Clothes

- Do not wear loosely hanging clothes or jewellery etc. *They could become caught in the machine.*
- Wear gloves, sturdy shoes and long trousers to protect your legs.

Working Area

You are responsible for the safety of the working area.

- Make sure that there are no other people (especially children) or animals anywhere near the working area.

Area to be Cut

- Inspect the area to be cut before beginning. Remove any objects from the area.
- Look for objects while you are working.
- If you should come across any obstacles when cutting, turn off the shears by releasing the start button.

Operating Your Accu Shears



WARNING !
Personal Injury and Damage !

- Keep your hands and feet away from the cutting tool, especially when the Accu Shears are switched on!
- Never switch on the Accu Shears while you are adjusting the cutting head.

- If the cutting blades become blocked, switch off the shears immediately (release the switch on button and remove the object (thick branch or another object) using a blunt device.

Charging the Accu



FIRE RISK !

- Never charge the Accu Shears near acids or easily inflammable materials.

Only use the original GARDENA Battery Charger for charging. The use of other battery chargers may damage the batteries irreparably and even cause a fire.

The charging cable should be checked regularly for signs of damage or ageing (brittleness) and should only be used if it is in perfect condition.

Non-rechargeable batteries must not be charged with this battery charger (danger of fire).

The Accu Shears must not be operated while the battery is charging.

Only charge battery between 10 – 45 °C. After prolonged use allow battery to cool down first.

Working Conditions



RISK OF EXPLOSION !

- Protect Accu Shears from heat and fire.

Do not leave on radiators or expose to strong sunshine for long periods.

Only use Accu Shears in an ambient temperature between –10 °C and +45 °C.

Only work when visibility is good.

Be particularly careful when walking backwards. You might stumble!

- When working ensure you adopt a sturdy stance.

Interrupting Your Work

- Never leave the Accu Shears un-attended at the working area. If you should interrupt your work, store the Shears in a safe place.
- If you interrupt your work to move to another working area, you must switch off the Accu Shears until you reach the new working area (release the start button).

→ Never use your Accu Shears when it is raining or in a damp, wet area.

→ When transporting the Accu Shears always cover the blade with the blade guard.

3. Assembly

Fitting / Removing the Wheels:

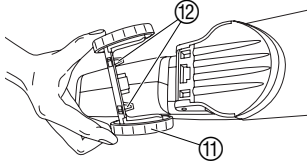

The wheels are only included with the lawn edging shears. (These can be ordered subsequently via GARDENA Service).

Fitting the Wheels:

→ Push the wheels ⑪ into the Accu Shears from below until both catches ⑫ click into place.

Removing the Wheels:

→ Press both wheels ⑪ together on the underside of the Accu Shears and remove.

Fitting / Removing the Telescopic Swivel Handle:

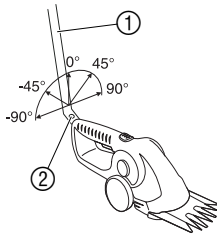

The **GARDENA Telescopic Swivel Handle Art. No. 8806** (available as an accessory) can be mounted in 45° steps from 90° to -90°.

Fitting the Telescopic Swivel Handle:

→ Guide the swivel handle ① at the desired angle into the handle holder of the Accu Shears until the lock engages.

Removing the Telescopic Swivel Handle:

→ Press the release button ② and pull out the swivel handle.

The starting lockout and ON button on the Accu Shears no longer function when the swivel handle is mounted.

For assembly of blades see 8. Troubleshooting “Replacing the Cutting Blades”.

4. Initial Operation

Charging the Accu:

The battery should be fully charged before using for the first time. Charging time (with flat battery): Accu 60 approx. 5 hrs, Accu 80 approx. 6 hrs, Accu 100 approx. 7 hrs.

The lithium-ion battery can be re-charged in any state of charge, and the charging process can be interrupted at any time without damaging the battery (no memory effect).



WARNING !

Incorrect mains voltage damages batteries and the battery charger.

→ **Ensure the correct mains voltage.**

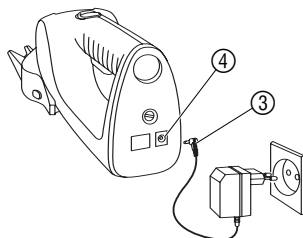

1. Insert charging cable ③ into charging socket ④ of Accu Shears.

2. Plug battery charger into a mains socket.

*During charging socket ④ lights up red.
The battery is being charged.*

When the charging socket ④ no longer lights up red, the battery is fully charged.

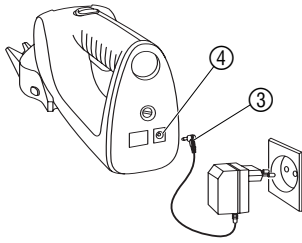

3. First remove the charging cable (3) from the charging socket (4) and then unplug the battery charger from the mains socket.

When there is a sharp fall in the power of the Accu Shears, the battery needs to be charged. Do not wait until the blade comes to an absolute stop.

If the charging socket flashes red during charging, a fault has occurred (see 8. Troubleshooting).

5. Operating Your Accu Shears

WARNING!
Risk of Injury



There is a risk of injury if the switching devices installed on the Shears are removed or bridged (e.g. by fastening the on switch to the handle). This prevents the Accu Shears switching off automatically.

→ **Never remove or bridge the switching devices.**

The starting lockout prevents your GARDENA Accu Shears from being switched on unintentionally.

Cutting Grass / Bushes and Shrubs:



1. **Edging Accu Shears:** Clear the area to be cut of stones and other solid objects and remove the blade guard (6) from the cutting blade.

Accu Shrub Shears: Remove the blade guard (6) from the cutting blade.

2. **Ergonomic design:** Press the cutting head (7) and adjust the handle to the desired angle.

3. **Cutting:** Disengage the starting lockout (8) by pushing it forwards and press the ON button (9). Release the starting lockout (8) again.

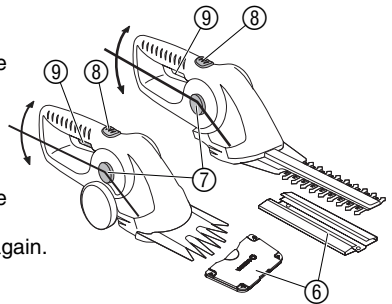

Cutting with the Telescopic Swivel Handle:

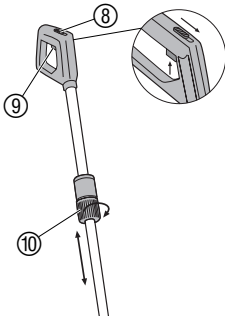

The **GARDENA Telescopic Swivel Handle Art. No. 8806** for the Accu Shears can be mounted in 45° steps (see 3. Assembly). The swivel handle is fully height adjustable (85 – 120 cm) and can be adapted to suit your height.

1. Attach the Telescopic Swivel Handle (see 3. Assembly).
2. Loosen the adjusting bolt (10).
3. Set the handle to the correct length and tighten the adjusting bolt (10).
4. Disengage the starting lockout (8) by pushing it forwards and press the ON button (9).
5. Release the starting lockout (8) again.

6. Putting into Storage

Storage / Overwintering:

Store your Accu Shears out of the reach of children.

1. Clean the Accu Shears and oil the blades (See 7. Maintenance).
2. Cover the blades with sheath for storage.
3. Store Shears in a cool, dry place where they are protected from frost.

Disposal:

(in accordance with
RL2002/96/EC)



The product must not be added to normal household waste. It must be disposed of in line with local environmental regulations.

Disposal of batteries:



The GARDENA Accu Shears contains lithium-ion cells that should not be discarded with normal household waste at the end of their life.

Please return the lithium-ion cells to your GARDENA dealer or dispose of them properly at a public recycling centre.

1. Discharge lithium-ion cells completely.
2. Dispose of lithium-ion cells properly.

7. Maintenance

DANGER! Risk of Injury!



Blades can cause injury.

→ Do not push the safety lock of the Accu Shears forwards during maintenance work.

WARNING! Personal Injury and Damage to Property!



There is a risk of personal injury and damage to the Shears if you clean them under running water (especially under high pressure).

→ Never clean your Shears under running water.

Sharpening the Blades:

To obtain good cutting results, the blades should be cleaned thoroughly from time to time and should always be sharp.

Always remove notches and burrs caused by stones etc. immediately.

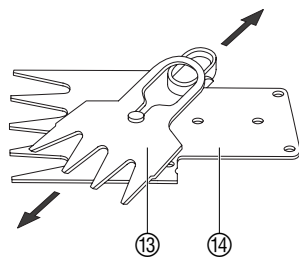

1. Remove the blades (see 8. Troubleshooting, "Replacing Cutting Blades").
2. Separate the upper blade ⑬ and lower blade ⑭.
3. Remove any grass and dirt between the upper and lower blades.
4. Sharpen the blades using a sharpening stone.
5. Fit the blades (see 8. Troubleshooting, "Replacing Cutting Blades").

Cleaning the Accu Shears and Oiling the Blades:

To increase the cutting performance and operating life of your Accu Shears, you should clean and oil them both before and after every use.

1. Clean your Accu Shears with a damp cloth.
2. Oil the cutting blades with **GARDENA Cleaning Spray Art. No. 2366** or sewing machine oil, for example.

8. Troubleshooting

DANGER!
Risk of Injury!



Blades can cause serious injury.

→ **Do not push the safety lock of the Accu Shears forwards when rectifying faults.**

Replacing the Cutting Blades:

If the Accu Shears do not cut cleanly even after thorough cleaning, the cutting blades are defective and must be replaced with new ones.

Please only use original GARDENA Accu Shears Cutting Blades.

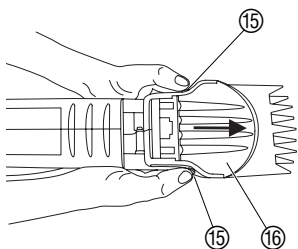

Edging Shears blade set	Accu 60 / 80	Art.-No. 2345
	Accu 100	Art.-No. 2346
Shrub Shears blade set	Accu 80 / 100	Art.-No. 5378

1. Remove the wheels (see 3. Assembly).
2. Press both catches (15) simultaneously and push the runner (16) all the way forwards.
3. Open the runner (16) and remove the blade set (17).
4. Clean the area around the gears and coat the gear wheels with acid-free grease (Vaseline).
5. Insert the blade set (17) and close the runner (16).
6. Push the runner (16) all the way back until both catches (15) engage again.

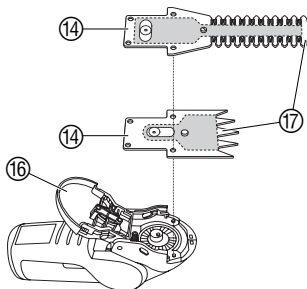

During charging socket flashes red:

A fault has occurred during charging.

→ Unplug and reinsert charging cable.

The fault will be reset.

If this does not eliminate the fault, please contact GARDENA Service.

The batteries are replaceable. Should you require a new battery, please contact GARDENA Service.



In the event of other faults please also get in touch with GARDENA Service. Repairs should only be carried out by GARDENA service centres or dealers authorised by GARDENA.

9. Accessories

Telescopic Swivel Handle	Suitable for all GARDENA Accu Shears	Art. No. 8806
Blades for Edging Shears	Accu 60/Accu 80 (Cutting width 8 cm)	Art.-No. 2345
Blades for Edging Shears	Accu 100 (Cutting width 10 cm)	Art.-No. 2346
Blades for Shrub Shears	Accu 80/Accu 100	Art.-No. 5378
Wheels	Suitable for all GARDENA Accu Shears	obtainable via GARDENA Service
Spare battery	For Accu 60/ Accu 80/ Accu 100	obtainable via GARDENA Service

10. Technical Data

	Accu Edging Shears			Accu Shrub Shears	
	Accu 60 Art. 8801	Accu 80 Art. 8803	Accu 100 Art. 8805	Accu 80 Art. 8824	Accu 100 Art. 8825
Battery	1 Li-ion 1,1Ah	2 Li-ion 1,1Ah	3 Li-ion 1,1Ah	2 Li-ion 1,1Ah	3 Li-ion 1,1Ah
Battery capacity	à 3,6V= 3.6 V	à 3,6V= 7.2 V	à 3,6V= 10.8 V	à 3,6V= 7.2 V	à 3,6V= 10.8 V
Battery charging time	approx. 5 hrs	approx. 6 hrs	approx. 7 hrs	approx. 6 hrs	approx. 7 hrs
Battery charger					
Mains voltage	230 V / 50 Hz	230 V / 50 Hz	230 V / 50 Hz	230 V / 50 Hz	230 V / 50 Hz
Rated output current	130 mA	130 mA	130 mA	130 mA	130 mA
Max. output voltage	20 V (DC)	20 V (DC)	20 V (DC)	20 V (DC)	20 V (DC)
Running time (with fully charged accu)	approx. 60 min	approx. 80 min	approx. 100 min	approx. 80 min	approx. 100 min
Cutting performance	approx. 1100 m	approx. 1400 m	approx. 1500 m		
Lawn blade	8 cm cutting width	8 cm cutting width	10 cm cutting width	20 cm cutting length	20 cm cutting length
Weight	approx. 850 g	approx. 900 g	approx. 950 g	approx. 1000 g	approx. 1050 g
Working area related emission characteristic value $L_{pA}^{1)}$	78 dB (A)	78 dB (A)	82 dB (A)		
Noise level $L_{WA}^{2)}$				77 dB (A)	73 dB (A)
Hand / Arm vibrations $a_{vhw}^{1)}$	< 2,5 m/s ²	< 2,5 m/s ²	< 2,5 m/s ²	< 2,5 m/s ²	< 2,5 m/s ²

Measuring method according to 1) prEN 50260-1 2) RL 2000/14/EG

11. Service / Warranty

GARDENA guarantees this product for 2 years (from date of purchase). This guarantee covers all serious defects of the unit that can be proved to be material or manufacturing faults. Under warranty we will either replace the unit or repair it free of charge if the following conditions apply:

- The unit must have been handled properly and in keeping with the requirements of the operating instructions.
- Neither the purchaser nor a non-authorised third party have attempted to repair the unit.

The Trimmer Blades are wearing parts and are not covered by the guarantee.

This manufacturer's guarantee does not affect the user's existing warranty claims against the dealer / seller.

If a fault occurs with your Edging Accu Shears, please return the faulty unit together with the receipt and a description of the fault, with postage paid to the address of the Service Centre on the back of these operating instructions.

<p>D <i>Produkthftung</i></p>	<p>Wir weisen ausdrücklich darauf hin, dass wir nach dem Produkthaftungsgesetz nicht für durch unsere Geräte hervorgerufene Schäden einzustehen haben, sofern diese durch unsachgemäße Reparatur verursacht oder bei einem Teileaustausch nicht unsere Original GARDENA Teile oder von uns freigegebene Teile verwendet werden und die Reparatur nicht vom GARDENA Service oder dem autorisierten Fachmann durchgeführt wird. Entsprechendes gilt für Ergänzungssteile und Zubehör.</p>
<p>GB <i>Product Liability</i></p>	<p>We expressly point out that, in accordance with the product liability law, we are not liable for any damage caused by our units if it is due to improper repair or if parts exchanged are not original GARDENA parts or parts approved by us, and, if the repairs were not carried out by a GARDENA Service Centre or an authorised specialist. The same applies to spare parts and accessories.</p>
<p>F <i>Responsabilité</i></p>	<p>Nous vous signalons expressément que GARDENA n'est pas responsable des dommages causés par ses appareils, dans la mesure où ces dommages seraient causés suite à une réparation non conforme, dans la mesure où, lors d'un échange de pièces, les pièces d'origine GARDENA n'auraient pas été utilisées, ou si la réparation n'a pas été effectuée par le Service Après-Vente GARDENA ou l'un des Centres SAV agréés GARDENA. Ceci est également valable pour tout ajout de pièces et d'accessoires autres que ceux préconisés par GARDENA.</p>
<p>NL <i>Productaansprakelijkheid</i></p>	<p>Wij wijzen er nadrukkelijk op, dat wij op grond van de wet aansprakelijkheid voor producten niet aansprakelijk zijn voor schade ontstaan door onze apparaten, indien deze door onvakkundige reparatie veroorzaakt zijn, of er bij het uitwisselen van onderdelen geen gebruik gemaakt werd van onze originele GARDENA onderdelen of door ons vrijgegeven onderdelen en de reparatie niet door de GARDENA technische dienst of de bevoegde vakman uitgevoerd werd. Ditzelfde geldt voor extra-onderdelen en accessoires.</p>
<p>S <i>Produktansvar</i></p>	<p>Tillverkaren är inte ansvarig för skada som orsakats av produkten om skadan beror på att produkten har reparerats felaktigt eller om, vid reparation eller utbyte, andra än Original GARDENA reservdelar har använts. Samma sak gäller för kompletteringsdelar och tillbehör.</p>
<p>I <i>Responsabilità del prodotto</i></p>	<p>Si rende espressamente noto che, conformemente alla legislazione sulla responsabilità del prodotto, non si risponde di danni causati da nostri articoli se originati da riparazioni eseguite non correttamente o da sostituzioni di parti effettuate con materiale non originale GARDENA o comunque da noi non approvato e, in ogni caso, qualora l'intervento non venga eseguito da un centro assistenza GARDENA o da personale specializzato autorizzato. Lo stesso vale per le parti complementari e gli accessori.</p>
<p>E <i>Responsabilidad de productos</i></p>	<p>Advertimos que conforme a la ley de responsabilidad de productos no nos responsabilizamos de daños causados por nuestros aparatos, siempre y cuando dichos daños hayan sido originados por arreglos o reparaciones indebidas, por recambios con piezas que no sean piezas originales GARDENA o bien piezas autorizadas por nosotros, así como en aquellos casos en que la reparación no haya sido efectuada por un Servicio Técnico GARDENA o por un técnico autorizado. Lo mismo es aplicable para las piezas complementarias y accesorios.</p>
<p>P <i>Responsabilidade sobre o produto</i></p>	<p>Queremos salientar que segundo a lei da responsabilidade do fabricante, nós não nos responsabilizaremos por danos causados pelo nosso equipamento, quando estes ocorram em decorrência de reparações inadequadas ou da substituição de peças por peças não originais da GARDENA, ou peças não autorizadas. A responsabilidade tornar-se-à nula também depois de reparações realizadas por oficinas não autorizadas pela GARDENA. Esta restrição valerá também para peças adicionais e acessórios.</p>
<p>DK <i>Produktansvar</i></p>	<p>Vi gør udtrykkeligt opmærksom på at i henhold til produktansvarsloven er vi ikke ansvarlige for skader forårsaget af vores udstyr, hvis det skyldes uautoriserede reparationer eller hvis dele er skiftet ud og der ikke er anvendt originale GARDENA dele eller dele godkendt af os, eller hvis reparationerne ikke er udført af GARDENA-service eller en autoriseret fagmand. Det samme gælder for ekstra udstyr og tilbehør.</p>

<p>D EU-Konformitätserklärung Maschinenverordnung (9. GSGVO) / EMVG / Niedersp. RL Der Unterzeichnete GARDENA Manufacturing GmbH, Hans-Lorenser-Str. 40, D-89079 Ulm, bestätigt, dass das nachfolgend bezeichnete Gerät in der von uns in Verkehr gebrachten Ausführung die Anforderungen der harmonisierten EU-Richtlinien, EU-Sicherheitsstandards und produktspezifischen Standards erfüllt. Bei einer nicht mit uns abgestimmten Änderung des Gerätes verliert diese Erklärung ihre Gültigkeit.</p>	<p>Bezeichnung des Gerätes: Accu-Rasenkantenschere / Accu-Strauchschere / Edging Accu Shears / Accu Shrub Shears Description of the unit: Cisailles à gazon sur accu / Taille-buissons sur accu Désignation du matériel : Accu-graskantenscharen / Accu-buxusschaar Omschrijving van het apparaat: Accu Graskantsaxar / Accu Busktrimmer Produktbeskrivning: Forbici a batteria Accu / Cesioie a batteria Descrizione del prodotto: Tijeras Accu / Recortasetos sin cable Descrizzione de la mercancia: Tesoura com Acumulador / Tesoura para arbustos com acumulador Descrição do aparelho: Accu-graskantklipper / Accu-busktrimmer Beskrivelse af enhederne:</p>
<p>GB EU Certificate of Conformity The undersigned GARDENA Manufacturing GmbH, Hans-Lorenser-Str. 40, D-89079 Ulm, hereby certifies that, when leaving our factory, the unit indicated below is in accordance with the harmonised EU guidelines, EU standards of safety and product specific standards. This certificate becomes void if the unit is modified without our approval.</p>	<p>Typ: Art.-Nr.: Type: Art. No.: Type : Référence : 8801 Type: Accu 60 Art. nr.: 8803 Type: Accu 80 Art.nr.: 8805 Modello: Accu 100 Art.: 8824 Tipo: Art. Nº: 8825 Tipo: Art. Nº: Type: Varen. :</p>
<p>F Certificat de conformité aux directives européennes Le constructeur, soussigné : GARDENA Manufacturing GmbH, Hans-Lorenser-Str. 40, D-89079 Ulm, déclare qu'à la sortie de ses usines le matériel neuf désigné ci-dessous éait conforme aux prescriptions des directives européennes énoncées ci-après et conforme aux règles de sécurité et autres règles qui lui sont applicables dans le cadre de l'Union européenne. Toute modification portée sur ce produit sans l'accord express de GARDENA supprime la validité de ce certificat.</p>	<p>EU-Richtlinien : 98/37/EC EU directives : 89/336/EC Directives européennes : 73/23/EC* EU-richtlijnen : 93/68/EC EU direktiv : Ladegerät*, Charging Unit* Directive UE: Chargeur*, Netroomadapter* Normativa UE: Laddare*, Unità di ricarica* Directrices da UE: Terminal de recarga* Carregador* EU Retningslinier: Art. 8824 / 8825 2000 / 14 / EG</p>
<p>NL EU-overeenstemmingsverklaring Ondergetekende GARDENA Manufacturing GmbH, Hans-Lorenser-Str. 40, D-89079 Ulm, bevestigt, dat het volgende genoemde apparaat in de door ons in de handel gebrachte uitvoering voldoet aan de eis van, en in overeenstemming is met de EU-richtlijnen, de EU-veiligheidsstandaard en de voor het product specifieke standaard. Bij een niet met ons afgestemde verandering aan het apparaat verliest deze verklaring haar geldigheid.</p>	<p>Schall-Leistungspegel: gemessen / garantiert Noise level: measured / guaranteed Puissance acoustique : mesurée / garantie Geluidsniveau: gemeten / gegarandeerd Ljudnivå: uppmätt / garanterat Livello rumorosità: testato / garantito Nível sonoro: medido / garantizado Nível de ruído: medido / garantido Lydtryksniveau: afmålt / garanti Art. 8824 77 dB (A) / 79 dB (A) Art. 8825 73 dB (A) / 75 dB (A)</p>
<p>S EU Tillverkarintyg Undertecknad firma GARDENA Manufacturing GmbH, Hans-Lorenser-Str. 40, D-89079 Ulm, intygar härmed att nedan nämnda produkter överensstämmer med EU:s direktiv, EU:s säkerhetsstandard och produktspecifikation. Detta intyg upphör att gälla om produkten ändras utan vårt tillstånd.</p>	<p>Anbringningsår der CE-Kennzeichnung: Year of CE marking: Date d'apposition du marquage CE : Installatiejaar van de CE-aanduiding: CE-Märkningsår: 2006 Anno di rilascio della certificazione CE: Colocación del distintivo CE: Ano de marcação pela CE: CE-Mærkningsår:</p>
<p>I Dichiarazione di conformità alle norme UE La sottoscritta GARDENA Manufacturing GmbH, Hans-Lorenser-Str. 40, D-89079 Ulm, certifica che il prodotto qui di seguito indicato, nei modelli da noi commercializzati, è conforme alle direttive autorizzate UE nonché agli standard di sicurezza e agli standard specifici di prodotto. Qualunque modifica apportata al prodotto senza nostra specifica autorizzazione invalida la presente dichiarazione.</p>	<p>E Declaración de conformidad de la UE El que suscribe GARDENA Manufacturing GmbH, Hans-Lorenser-Str. 40, D-89079 Ulm, declara que la presente mercancía, objeto de la presente declaración, cumple con todas las normas de la UE, en lo que a normas técnicas, de homologación y de seguridad se refiere. En caso de realizar cualquier modificación en la presente mercancía sin nuestra previa autorización, esta declaración pierde su validez.</p>
<p>P Certificado de conformidad da UE Os abaixo mencionados GARDENA Manufacturing GmbH, Hans-Lorenser-Str. 40, D-89079 Ulm, por este meio certificam que ao sair da fábrica o aparelho abaixo mencionado está de acordo com as diretrizes harmonizadas da UE, padrões de segurança e de produtos específicos. Este certificado ficará nulo se a unidade for modificada sem a nossa aprovação.</p>	<p>DK EU Overensstemmelse certificat Undertegnede GARDENA Manufacturing GmbH, Hans-Lorenser-Str. 40, D-89079 Ulm bekræfter hermed, at enheder listet herunder, ved afsendelse fra fabrikken, er i overensstemmelse med harmoniserede EU retningslinier, EU sikkerhedsstandarder og produktspecifikationsstandarder. Dette certifikat træder ud af kraft hvis enhederne er ændret uden vor godkendelse.</p>
<p>Ulm, den 01.07.2006 Ulm, 01.07.2006 Fait à Ulm, le 01.07.2006 Ulm, 01-07-2006 Ulm, 2006.07.01. Ulm, 01.07.2006 Ulm, 01.07.2006 Ulm, 01.07.2006 Ulm, 01.07.2006 Ulm, 01.07.2006</p>	<p> Peter Lameli Technische Leitung Technical Dept. Manager Direction technique Hoofd technische dienst Technical Director Direzione Tecnica Dirección Técnica Director Técnico Teknisk direktør</p>

Deutschland / Germany

GARDENA
Manufacturing GmbH
Service Center
Hans-Lorenser-Straße 40
D-89079 Ulm
Produktfragen:
(+49) 731 490-123
Reparaturen:
(+49) 731 490-290
service@gardena.com

Argentina

Argensem® S.A.
Calle Colonia Japonesa s/n
(1625) Loma Verde
Escobar, Buenos Aires
Phone: (+54) 34 88 49 40 40
info@argensem.com.ar

Australia

Nylex Consumer Products
50-70 Stanley Drive
Somerton, Victoria, 3062
Phone: (+61) 1800 658 276
spare.parts@nylex.com.au

Austria / Österreich

GARDENA
Österreich Ges.m.b.H.
Stettnerweg 11-15
2100 Korneuburg
Tel.: (+43) 22 62 7 45 45 36
kundendienst@gardena.at

Belgium

GARDENA Belgium NV/SA
Sterrebeekstraat 163
1930 Zaventem
Phone: (+32) 2 7 20 92 12
Mail: info@gardena.be

Brazil

Palash Comércio e
Importação Ltda.
Rua Américo Brasiliense,
2414 - Chácara Sto Antonio
São Paulo - SP - Brasil -
CEP 04715-005
Phone: (+55) 11 5181-0909
eduardo@palash.com.br

Bulgaria

DENEX LTD.
2 Luis Ahalier Str. - 7th floor
Sofia 1404
Phone: (+359) 2 958 18 21
office@denex-bg.com

Canada

GARDENA Canada Ltd.
100 Summerlea Road
Brampton, Ontario L6T 4X3
Phone: (+1) 905 792 93 30
info@gardenacanada.com

Chile

Antonio Martinic y Cia Ltda.
Cassillas 272
Centro de Cassillas
Santiago de Chile
Phone: (+56) 2 20 10 708
garfar_cl@yahoo.com

Costa Rica

Compania Exim
Euroberoamericana S.A.
Los Colegios, Moravia,
200 metros al Sur del Colegio
Saint Francis - San José
Phone: (+506) 297 68 83
exim_euro@racsa.co.cr

Croatia

KLIS d.o.o.
Stanciceva 79
10419 Vukovina
Phone: (+385) 1 622 777 0
gardena@klis-trgovina.hr

Cyprus

FARMOKIPIKI LTD
P.O. Box 7098
74, Digeni Akritra Ave.
1641 Nicosia
Phone: (+357) 22 75 47 62
condam@spidernet.com.cy

Czech Republic

GARDENA spol. s r.o.
Řípská 20a, č.p. 1153
627 00 Brno
Phone: (+420) 800 100 425
gardena@gardenabmo.cz

Denmark

GARDENA Norden AB
Salgsafdeling Danmark
Box 9003
S-200 39 Malmö
info@gardena.dk

Finland

Habitec Oy
Martinkyläntie 52
01720 Vantaa

France

GARDENA
PARIS NORD 2
69, rue de la Belle Etoile
BP 57080
ROISSY EN FRANCE
95948 ROISSY CDG CEDEX
Tél. (+33) 0826 101 455
service.consommateurs@
gardena.fr

Great Britain

GARDENA UK Ltd.
27-28 Brenkley Way
Bleazard Business Park
Seaton Burn
Newcastle upon Tyne
NE13 6DS
info@gardena.co.uk

Greece

Agrokrip
Psomadopoulos S.A.
Ifaistou 33A
Industrial Area Koropi
194 00 Athens Greece
V.A.T. EL093474846
Phone: (+30) 210 66 20 225
service@agrokrip.gr

Hungary

GARDENA
Magyarország Kft.
Késmárk utca 22
1158 Budapest
Phone: (+36) 80 20 40 33
gardena@gardena.hu

Iceland

Ó. Johnson & Kaaber
Tunguhalsi 1
110 Reykjavik
oaj@ojk.is

Ireland

Michael McLoughlin & Sons
Hardware Limited
Long Mile Road
Dublin 12

Italy

GARDENA Italia S.p.A.
Via Donizetti 22
20020 Lainate (Mi)
Phone: (+39) 02.93.94.79.1
info@gardenaitalia.it

Japan

KAKUICHI Co. Ltd.
Sumitomo Realty &
Development Kojimachi
BLDG., 8F
5-1 Nibannayo, Chiyoda-ku
Tokyo 102-0084
Phone: (+81) 33 264 4721
m_ishihara@kaku-ichi.co.jp

Luxembourg

Magasins Jules Neuberg
Grand Rue 30
Boîte postale 12
L-2010 Luxembourg
Phone: (+352) 40 14 01
info@neuberg.lu

Netherlands

GARDENA Nederland B.V.
Postbus 50176
1305 AD ALMERE
Phone: (+31) 36 521 00 00
info@gardena.nl

Neth. Antilles

Jonka Enterprises N.V.
Sta. Rosa Weg 196
P.O. Box 8200
Curaçao
Phone: (+599) 9 767 66 55
pgm@jonka.com

New Zealand

NYLEX New Zealand Limited
Building 2, 118 Savill Drive
Mangere, Auckland
Phone: (+64) 9 270 1806
lena.chapman@nylex.com.au

Norway

GARDENA Norden AB
Salgskontor Norge
Karihaugveien 89
1086 Oslo
info@gardena.no

Poland

GARDENA Polska Sp. z o.o.
Szymanów 9 d
05-532 Baniocza
Phone: (+48) 22 727 56 90
gardena@gardena.pl

Portugal

GARDENA Portugal Lda.
Recta da Granja do Marquês
Edif. GARDENA Algueirão
2725-596 Mem Martins
Phone: (+351) 21 922 85 30
info@gardena.pt

Romania

MADEX INTERNATIONAL SRL
Soseaua Odaii 117-123,
Sector 1,
București, RO 013603
Phone: (+40) 21 352 76 03
madex@ines.ro

Russia / Россия

АО АМИДА ТТЦ
ул. Мосфильмовская 66
117330 Москва
Phone: (+7) 095 956 99 00
amida@col.ru

Singapore

Hy - Ray PRIVATE LIMITED
40 Jalan Pemimpin
#02-08 Tat Ann Building
Singapore 577185
Phone: (+65) 6253 2277
hyray@singnet.com.sg

Slovak Republic

GARDENA Slovensko, s.r.o.
Panónska cesta 17
851 04 Bratislava
Phone: (+421) 263 453 722
info@gardena.sk

Slovenia

Silk d.o.o.
Brodišče 15
1236 Trzin
Phone: (+386) 1 580 93 00
gardena@silk.si

South Africa

GARDENA
South Africa (Pty.) Ltd.
P.O. Box 11534
Vorna Valley 1686
Phone: (+27) 11 315 02 23
sales@gardena.co.za

Spain

GARDENA IBÉRICA S.L.U.
C/ Basauri, nº 6
La Florida
28023 Madrid
Phone: (+34) 91 708 05 00
atencioncliente@gardena.es

Sweden

GARDENA Norden AB
Försäljningskontor Sverige
Box 9003
200 39 Malmö
info@gardena.se

Switzerland / Schweiz

GARDENA (Schweiz) AG
Bitzberg 1
1814 Bachenbülach
Phone: (+41) 848 800 464
info@gardena.ch

Turkey

GARDENA / Dost Diş Ticaret
Müessesilik A.Ş. Sanayi
Çad. Adil Sokak No. 1
Kartal - İstanbul
Phone: (+90) 216 38 93 939
info@gardena-dost.com.tr

Ukraine / Украина

ALTSEST JSC
4 Petropavlivska Street
Petropavlivska
Borschahivka Town
Kyivo Svyatoshyn Region
08130, Ukraine
Phone: (+380) 44 459 57 03
upryr@altsest.kiev.ua

USA

Melnor Inc.
3085 Shawnee Drive
Winchester, VA 22604
Phone: (+1) 540 722-9080
service_us@melnor.com

8801-20.960.01/0706

© GARDENA
Manufacturing GmbH
D-89070 Ulm
http://www.gardena.com