

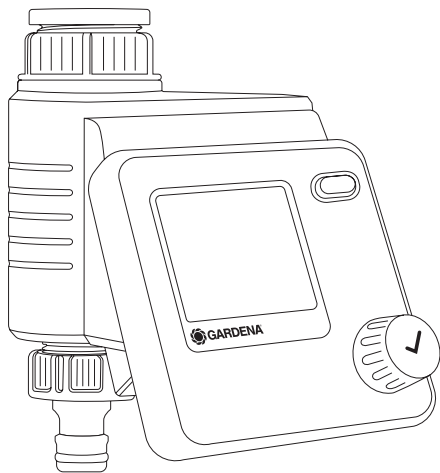

Select

Art. 1891



EN **Operator's manual**

Water Control

SV **Bruksanvisning**

Bevattningsautomatik

DA **Brugsvejledning**

Vandingskontrol

FI **Käyttöohje**

Kastelunohjaus

NO **Bruksanvisning**

Vanningsstyring

ET **Kasutusjuhend**

Kastmissüsteemi juhtseade

LT **Eksplotavimo instrukcija**

Laistymo valdiklis

LV **Lietošanas instrukcija**

Laistīšanas kontrolierīce

EN

SV

DA

FI

NO

ET

LT

LV

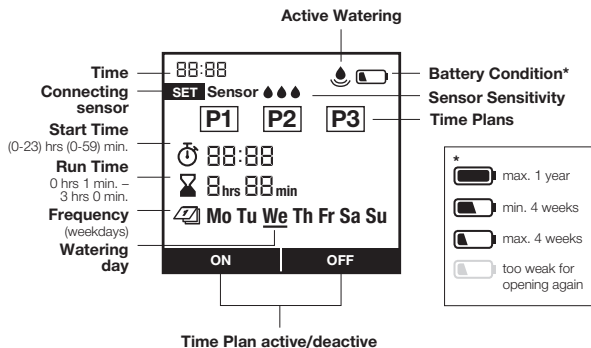
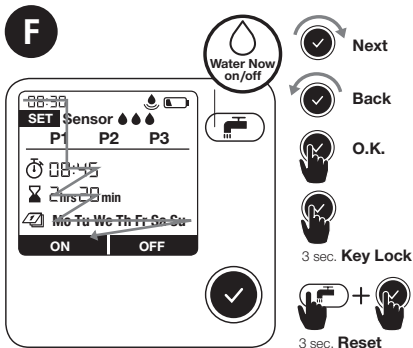
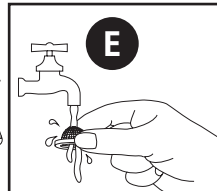
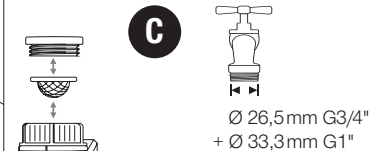
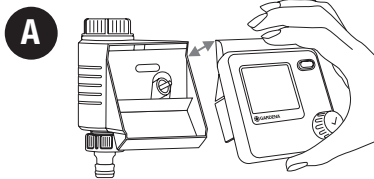

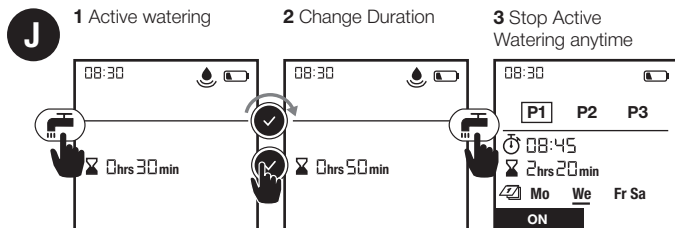
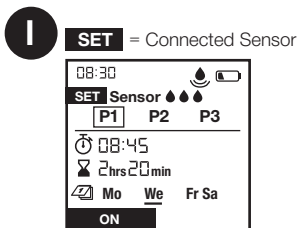
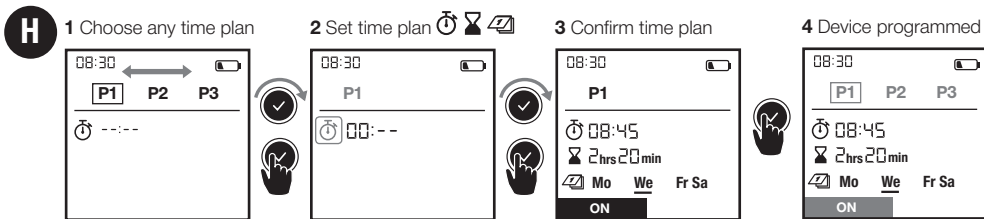
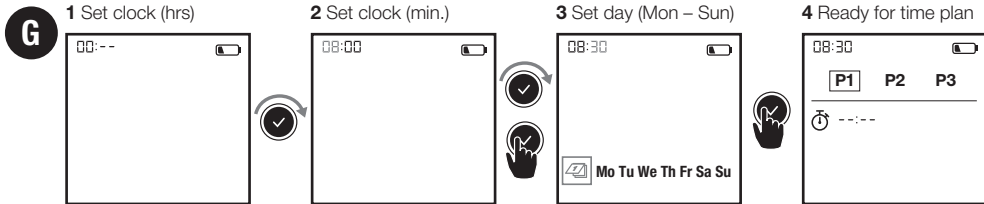

GARDENA Water Control Select

Translation of the original instructions.



For safety reasons, children and young people under 16 as well as anyone who is not familiar with these operating instructions should not use the product. Persons with reduced physical or mental abilities may use the product only if they are supervised or instructed by a responsible person. Children must be supervised to ensure that they do not play with the product. Never operate the product when you are tired, ill or under the influence of alcohol, drugs or medicine.

Intended use:

The GARDENA Water Control is intended for private use in domestic and hobby gardens, exclusively for outdoor use, to control sprinklers and watering systems. The Water Control can be used for automatic watering during holidays.

DANGER! The GARDENA Water Control must not be used for industrial purposes or in conjunction with chemicals, foodstuffs, easily flammable and explosive materials.

1. SAFETY

Important!

Read the operator's manual carefully before use and keep for future reference.

Battery:

To ensure the Water Control runs safely, only a 9V alkaline manganese battery (alkaline) type IEC 6LR61 must be used!

In order to stop the Water Control from failing because of a weak battery if you are away for a long time, the battery must be replaced when the battery symbol flashes.

Setting up:

The Water Control may only be set up vertically with the sleeve nut to the top to prevent water penetrating into the battery compartment.

The minimum water output to ensure that the Water Control functions correctly is 20 – 30 l/h. For example, at least 10 x 2-litre Drip Heads are required to control the Micro-Drip-System.

At high temperatures (over 70 °C at the display) the LCD display may extinguish. This does not affect the program in any way. When the computer cools down the LCD display illuminates again.

The max. temperature for the water flow is 40 °C.

Avoid tensile strain.

→ Do not pull the hose connected to the Water Control.



CAUTION! If the control section is removed when the valve is open, the valve remains open until the control section is reattached.



DANGER! Cardiac arrest! This product makes an electromagnetic field while it operates. This field may under some conditions interfere with active or passive medical implants. To decrease the risk of conditions that can possibly injure or kill, we recommend persons with medical implants to speak with their physician and the medical implant manufacturer before you operate the product.



DANGER! Risk of suffocation! Small parts can be easily swallowed. There is also a risk that the polybag can suffocate toddlers. Keep toddlers away when you assemble the product.

A video of the commissioning and setting processes is available here:



2. INITIAL OPERATION → (Fig. A–D)

3. FUNCTION → (Fig. F)

You can change the settings or move to the next setting by turning the knob. You can confirm the respective input by pressing the rotary knob. Pressing the knob for a minimum of 3 seconds locks or unlocks the display.

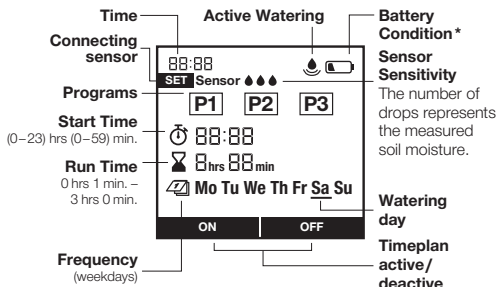

- *  max. 1 year
-  max. 4 weeks
-  min. 4 weeks
-  too weak for opening again

4. PROGRAMMING → (Fig. G–J)

Fig. G: 1 Set time (hours) | 2 Set time (mins) | 3 day setting (Mon – Sun) | 4 Ready for schedule

Fig. H: 1 Select schedule | 2 Set schedule | 3 Confirm schedule | 4 Device programmed

Fig. I: Set = Sensor connected

Fig. J: 1 Active watering | 2 Change watering duration | 3 Stop active watering at any time

P1, P2, P3 denote watering schedules. You can save up to 3 independent schedules. Schedules can be activated or deactivated by pressing on/off (see fig. H). During selection, selected watering days are displayed as underlined weekdays. In the standard display, only the selected days will subsequently be shown. The current weekday will be underlined.

By pressing the  button, manual watering can be started or stopped at a desired time (see fig. J).

Connect soil moisture sensor (optional) **fig. D:** After a sensor is connected, the “set sensor” display will appear – this can last for up to 1 minute. By selecting 3-drip/0-drip the sensor response will be activated/deactivated. After successful activa-

tion, the “set” display will disappear (see fig. I). If the soil is sufficiently moist, watering will be immediately stopped or prevented.

5. MAINTENANCE → (Fig. E)

6. STORAGE



To put into storage:

- The product must be stored away from children.
- To preserve the battery, it should be removed (fig. B).
- Store the controller and the valve unit in a dry, enclosed and frost-free place.



Disposal: (in accordance with RL2012/19/EC)

The product must not be disposed of to normal household waste. It must be disposed of in line with local environmental regulations.

IMPORTANT! Dispose of the product through or via your municipal recycling collection centre.

Disposal of the battery: Please return a flat battery to a GARDENA dealer or dispose of it properly at your nearest recycling centre. Dispose of the battery only when discharged.

7. TROUBLESHOOTING

Problem	Possible Cause	Remedy
No display appears	Battery is inserted incorrectly.	→ Check the polarity markings match (+/-).
	Battery is flat.	→ Insert a new (alkaline) battery.

Problem	Possible Cause	Remedy
No display appears	Temperature on the display is higher than 70 °C.	→ Display appears after the temperature has dropped.
Manual watering is not possible using the  button	Low battery is continuously displayed.	→ Insert a new (alkaline) battery.
	Tap is turned off.	→ Turn the tap on.
	Controller is not connected.	→ Mount the controller on housing.
	Minimum pressure of 0.5 bar not available.	→ Ensure a pressure of at least 0.5 bar.
Watering program is not being undertaken (no watering)	Program entry/ modification during or just before the start pulse.	→ Make program entry/ modification outside the programmed start times.
	Valve was opened manually previously.	→ Avoid possible program overlaps.
	Tap is turned off.	→ Turn the tap on.
	Soil moisture or rain sensor registers damp.	→ If dry, check the setting/ location of the soil moisture/ rain sensor.
	Controller is not connected.	→ Mount the controller on housing.
	Low battery is continuously displayed.	→ Insert a new (alkaline) battery.
	Minimum pressure of 0.5 bar not available.	→ Ensure a pressure of at least 0.5 bar.
Water Control does not close	Minimum quantity of water drawn is less than 20 l/h.	→ Connect more drip heads.
	Valve soiled.	→ Flush in the opposite direction to the normal flow direction.



NOTE: For any other malfunctions please contact the GARDENA service department. Repairs must only be done by GARDENA service departments or specialist dealers approved by GARDENA.

8. TECHNICAL DATA

Water Control	Value / Unit
Min./max. operating pressure	0.5 bar/12 bar
Operating temperature range	5 °C to 50 °C
Flow medium	Clear fresh water
Max. liquid temperature	40 °C
Number of program-controlled watering cycles per day	3

Water Control	Value / Unit
Number of program-controlled watering cycles per week	21
Watering duration	3 x 1 min. – 3 hrs.
Battery required	1 x 9V alkaline manganese Typ IEC 6LR61
Operating time of the battery	approximately 1 year

9. ACCESSORIES

GARDENA Soil Moisture Sensor

Art. 1188

GARDENA Anti-theft device

Art. 1815-00.791.00 from the GARDENA Service

10. SERVICE/WARRANTY

Service:

Please contact the address on the back page.

Warranty:

In the event of a warranty claim, no charge is levied to you for the services provided.

GARDENA Manufacturing GmbH offers a 2-year warranty for this product (from the date of purchase) if the product has been used exclusively for private purposes. This manufacturer's warranty does not apply to used products purchased from a secondary market. This warranty includes all significant defects of the product that can be proved to be material or manufacturing faults. This warranty is fulfilled by supplying a fully functional replacement product or by repairing the faulty product sent to us free of charge; we reserve the right to choose between these options. This service is subject to the following provisions:

- The product was used for its intended purpose as per the recommendations in the operating instructions.
- Neither the purchaser nor a third party has attempted to repair the product.

- Only original GARDENA spare and wear parts were used.

Normal wear and tear of parts and components, optical changes, as well as wear parts and consumables, are excluded from the warranty.

This manufacturer's warranty does not affect warranty entitlements against the dealer/retailer.

If problems arise with this product, please contact our Service department. In the event of a warranty claim, please send the defective product together with a copy of the purchase receipt and a description of the defect, sufficiently stamped, to the GARDENA service address on the back page.

Consumables:

Faults which occur as a result of incorrectly installed or leaking batteries are not covered by the guarantee.

Damage caused by frost is not covered by the warranty.

EN Product liability

In accordance with the German Product Liability Act, we hereby expressly declare that we accept no liability for damage incurred from our products where said products have not been properly repaired by a GARDENA-approved service partner or where original GARDENA parts or parts authorised by GARDENA were not used.

SV Produktansvar

I enlighet med tyska produktansvarslagar förklarar vi härmed uttryckligen att vi inte åtar oss något ansvar för skador som orsakas av våra produkter där produkterna inte har genomgått korrekt reparation från en GARDENA-godkänd servicepartner eller där originaldelar från GARDENA eller delar godkända av GARDENA inte använts.

DA Produktansvar

I overensstemmelse med den tyske produktansvarslov erklærer vi hermed udtrykkeligt, at vi ikke påtager os noget ansvar for skader på vores produkter, hvis de pågældende produkter ikke er blevet repareret korrekt af en GARDENA-godkendt servicepartner, eller hvor der ikke er brugt originale GARDENA-reservedele eller godkendte reservedele fra GARDENA.

FI Tuotevastuu

Saksan tuotevastuulain mukaisesti emme ole vastuussa laitteiden vaurioista, jos korjauksia ei ole tehnyt GARDENAn hyväksymä huoltoliike tai jos niiden syynä on muiden kuin alkuperäisten GARDENA-varaosien tai GARDENAn hyväksymien varaosien käyttö.

ET Tootevastutus

Vastavalt Saksamaa tootevastutusseadusele deklareerime käesolevaga selgesõnaliselt, et me ei kanna mingisugust vastutust meie toodetest tingitud kahjude eest, kui need tooted ei ole korrektselt parandatud GARDENA heakskiidetud hoolduspartneri poolt või kui parandamisel ei ole kasutatud GARDENA originaalosi või GARDENA volitatud osi.

LT Gaminio patikimumas

Mes aiškiai pareiškiame, kad, atsižvelgiant į Vokietijos gaminių patikimumo įstatymą, neprisiimame atsakomybės dėl bet kokios žalos, patirtos dėl mūsų gaminių, jeigu jie buvo netinkamai taisomi arba jų dalys buvo pakeistos neoriginaliomis GARDENA dalimis ar nepatvirtintomis dalimis, arba jeigu remonto darbai buvo atliekami ne GARDENA techninės priežiūros centro specialistų.

LV Atbildība par produkcijas kvalitāti

Saskaņā ar Vācijas likumu par atbildību par produkcijas kvalitāti ar šo mēs paziņojam, ka neuzņemamies atbildību par bojājumiem, kas radušies, lietojot mūsu izstrādājumus, kuru remontu nav veicis uzņēmuma GARDENA apstiprināts apkopes partneris vai kuru remontam netika izmantotas oriģinālās GARDENA detaļas vai detaļas, kuru lietošanu apstiprinājis uzņēmums GARDENA.

EN EC Declaration of Conformity

The undersigned, GARDENA Germany AB, PO Box 7454, S-103 92 Stockholm, Sweden, hereby certifies that, when leaving our factory, the units indicated below are in accordance with the harmonised EU guidelines, EU standards of safety and product specific standards. This certificate becomes void if the units are modified without our approval.

ET EÜ vastavusdeklaratsioon

Allakirjutanu GARDENA Germany AB, PO Box 7454, S-103 92 Stockholm, Rootsi, kinnitab käesolevaga, et tehases väljumisel vastavad allpool nimetatud seadmed harmoneeritud EL-i suunistele, EL-i ohutusstandarditele ja tootele eriomastele standarditele. See vastavuskinnitus kaotab kehtivuse, kui seadet muudetakse ilma meie heakskiiduta.

SV EG-försäkran om överensstämmelse

Undertecknad firma GARDENA Germany AB, PO Box 7454, S-103 92 Stockholm, Sverige, intygar härmed att nedan nämnda produkter, när de lämnar vår fabrik, överensstämmer med EU:s riktlinjer, EU:s säkerhetsstandarder och produktspecifika standarder. Detta intyg skall ogiltigförklaras om produkten ändras utan vårt godkännande.

LT EB atitikties deklaracija

GARDENA Germany AB, PO Box 7454, S-103 92 Stockholm, Sweden, garantuoja, kad iš gamyklos siunčiami toliau nurodyti įrenginiai atitinka suderintus EB reikalavimus, EB saugos ir konkrečius gaminių standartus. Pakeitus gaminį be mūsų patvirtinimo, nutraukiamas šio sertifikato galiojimas.

DA EU-overensstemmelseserklæring

Undertegnede, GARDENA Germany AB, PO Box 7454, S-103 92 Stockholm, Sverige erklærer hermed, at nedenfor anførte enheder er i overensstemmelse med de harmoniserede EU retningslinjer, EU-standarder for sikkerhed og produktspecifikke standarder, når de forlader fabrikken. Denne erklæring ugyldiggøres, hvis enhederne ændres uden vores godkendelse.

LV EK atbilstības deklarācija

Uzņēmums GARDENA Germany AB, PO Box 7454, S-103 92 Stockholm, Zviedrija, ar parakstu apliecina, ka tālāk minētās vienības, pamatot rūpniec, atbilst saskaņotajām ES vadlinijām, ES drošības standartiem un izstrādājumam specifiskajiem standartiem. Šis sertifikāts tiek anulēts, ja šīs vienības tiek modificētas bez mūsu apstiprinājuma.

FI EY-vaatimustenmukaisuusvakuutus

GARDENA Germany AB, PO Box 7454, S-103 92 Stockholm, Ruotsi, vakuuttaa täten, että alla mainitut laitteet ovat tehtaalta lähtiessään yhdenmukaistettujen EU-säännösten, EU:n turvastandardien ja tuotekohtaisten standardien mukaisia. Tämä vakuutus mitätöityy, jos laitteita muokataan ilman hyväksyntäämme.

<p>Description of the product: Beskrivning av produkten: Beskrivelse af produktet: Tuotteen kuvaus: Toote kirjeldus: Gaminio aprašas: Izstrādājuma apraksts:</p>	<p>Water Control Bevatningsautomatik Vandingskontrol Kastelunohjaus Kastmissüsteemi juhtseade Laistymo valdiklis Laistīšanas kontrolierīce</p>	<p>Year of CE marking: Märkningsår: CE-Mærkningsår: CE-merkin kiinnitysvuosi: CE-märgistuse paigaldamise aasta: Metai, kada pažymėta CE-ženklui: CE-marķējuma uzlikšanas gads:</p> <p style="text-align: right;">2018</p>
<p>Product type: Produkttyp: Produkttype: Tuotetyyppi: Tootetüüp: Gaminio tipas: Produkta veids:</p> <p>Select</p>	<p>Article number: Artikelnummer: Artikelnummer: Tuotenumero: Artiklinumber: Dalies numeris: Artikula numurs:</p> <p>1891</p>	
<p>EC-Directives: EU-direktiv: EF-direktiver: EY-direktiivit: EÜ direktiivid: EB direktyvos: EK direktīvas:</p> <p style="text-align: right;">2014/30/EC 2011/65/EC</p>	<p>Hinterlegte Dokumentation: GARDENA Technische Dokumentation, M. Kugler, 89079 Ulm</p> <p>Deposited Documentation: GARDENA Technical Documentation, M. Kugler, 89079 Ulm</p> <p>Documentation déposée: Documentation technique GARDENA, M. Kugler, 89079 Ulm</p>	<p style="text-align: right;"><i>Reinhard Pompe</i></p> <p style="text-align: right;">Reinhard Pompe Vice President</p>

Deutschland / Germany

GARDENA Manufacturing GmbH
Central Service
Hans-Lorenser-Straße 40
D-89079 Ulm
Produktfragen:
(+49) 731 490-123
Reparaturen:
(+49) 731 490-290
service@gardena.com

Albania

COBALT Sh.p.k.
Rr. Siri Kodra
1000 Tirana

Argentina

Husqvarna Argentina S.A.
Av.del Libertador 5954 –
Piso 11 – Torre B
(C1428ARP) Buenos Aires
Phone: (+54) 11 5194 5000
info.gardena@ar.husqvarna.com

Armenia

Garden Land Ltd.
61 Tigran Mets
0005 Yerevan

Australia

Husqvarna Australia Pty. Ltd.
Locked Bag 5
Central Coast BC
NSW 2252
Phone: (+ 61) (0) 2 4352 7400
customer.service@
husqvarna.com.au

Austria / Österreich

Husqvarna Austria GmbH
Industriezeile 36
4010 Linz
Tel. : (+43) 732 77 01 01-485
service.gardena@
husqvarnagroup.com

Azerbaijan

Firm Progress
a. Aliyev Str. 26A
1052 Baku

Belgium

Husqvarna België nv/sa
Gardena Division
Rue Eglise Van Opheim 111
1180 Uccle / Ukkel
Tel.: (+32) 2 720 92 12
Mail: info@gardena.be

Bosnia / Herzegovina

SILK TRADE d.o.o.
Industrijska zona Bukva bb
74260 Tešanj

Brazil

Husqvarna do Brasil Ltda
Av. Francisco Matarazzo,
1400 – 19ª andar
São Paulo – SP
CEP: 05001-903
Tel: 0800-112252
marketing.br.husqvarna@
husqvarna.com.br

Bulgaria

AGROLAND България АД
бул. 8 Декември, № 13
Офис 5
1700 Студентски град
София
Tel.: (+359) 24666910
info@agroland.eu

Canada / USA

GARDENA Canada Ltd.
100 Summerlea Road
Brampton, Ontario L6T 4X3
Phone: (+1) 905 792 93 30
info@gardenacanada.com

Chile

Maquinarias Agroforestales
Ltda. (Maga Ltda.)
Santiago, Chile
Avda. Chesterton
8355 comuna Las Condes
Phone: (+56) 2 202 4417
Dalton@maga.cl
Zipcode: 7560330

China

Husqvarna (Shanghai)
Management Co., Ltd.
富世华 (上海) 管理有限公司
3F, Beng Square B,
No207, Song Hong Rd.,
Chang Ning District,
Shanghai, PRC. 200335
上海市长宁区淞虹路207号明
基广场B座3楼, 邮编: 200335

Colombia

Husqvarna Colombia S.A.
Calle 18 No. 68 D-31, zona
Industrial de Montevideo
Bogotá, Cundinamarca
Tel. 571 2922700 ext. 105
jairo.salazar@husqvarna.com.co

Costa Rica

Compania Exim
Euroberoamericana S.A.
Los Colegios, Moravia,
200 metros al Sur del Colegio
Saint Francis – San José
Phone: (+506) 297 68 83
exim_euro@racsa.co.cr

Croatia

Husqvarna Austria GmbH
Industriezeile 36
4010 Linz
Tel. : (+43) 732 77 01 01-485
service.gardena@
husqvarnagroup.com

Cyprus

Med Marketing
17 Digeni Akritia Ave
P.O. Box 27017
1641 Nicosia

Czech Republic

Husqvarna Česko s.r.o.
Türkova 2319/5b
149 00 Praha 4 – Chodov
Bezplatná infolinka :
800 100 425
servis@cz.husqvarna.com

Denmark

GARDENA DANMARK
Lejrvej 19, st.
3500 Værløse
Tlf.: (+45) 70 26 47 70
husqvarna@husqvarna.dk
www.gardena.com / dk

Dominican Republic

BOSQUESA, S.R.L
Carretera Santiago Licey
Km. 5 ½
Esquina Copal II.
Santiago
Dominican Republic
Phone: (+809) 736-0333
joserbosquesa@claro.net.do

Ecuador

Husqvarna Ecuador S.A.
Arupos E1-181 y 10 de
Agosto Quito, Pichincha
Tel. (+593) 22800739
francisco.jacome@
husqvarna.com.ec

Estonia

Husqvarna Eesti OÜ
Valdeku 132
EE-11216 Tallinn
info@gardena.ee

Finland

Oy Husqvarna Ab
Gardena Division
Lautatarhankatu 8 B / PL 3
00581 HELSINKI
www.gardena.fi

France

Husqvarna France
9/11 Allée des pierres mayettes
92635 Gennevilliers Cedex
France
http : //www.gardena.com/ fr
N° AZUR: 0 810 00 78 23
(Prix d'un appel local)

Georgia

Transporter LLC
8/57 Belashvili street
0159 Tbilisi, Georgia
Phone: (+995) 322 14 71 71

Great Britain

Husqvarna UK Ltd
Preston Road
Aycliffe Industrial Park
Newton Aycliffe
County Durham
DL5 6UP
info.gardena@husqvarna.co.uk

Greece

Π.ΠΑΠΑΔΟΠΟΥΛΟΣ ΑΕΒΕ
Λεωφ. Αθηνών 92
Αθήνα
Τ.Κ.104 42
Ελλάδα
Τηλ. (+30) 210 5193 100
info@papadopoulos.com.gr

Hungary

Husqvarna Magyarország Kft.
Ezred u. 1-3
1044 Budapest
Telefon: (+36) 1 251-4161
vevoszolgalat.husqvarna@
husqvarna.hu

Iceland

Ó. Johnson & Kaaber
Tunguhalsi 1
110 Reykjavik
oo@ojk.is

Ireland

Husqvarna UK Ltd
Preston Road
Aycliffe Industrial Park
Newton Aycliffe
County Durham
DL5 6UP
info.gardena@husqvarna.co.uk

Italy

Husqvarna Italia S.p.A.
Via Santa Vecchia 15
23868 VALMADRERA (LC)
Phone: (+39) 0341.203.111
assistenza.italia@it.husqvarna.com

Japan
KAKUICHI Co. Ltd.
Sumitomo Realty &
Development Kojimachi
BLDG., 8F
5 -1 Nibanncyo
Chiyoda-ku
Tokyo 102-0084
Phone: (+81) 33 264 4721
m_ishihara@kaku-ichi.co.jp

Kazakhstan
LAMED Ltd.
155/1, Tazhibayevoy Str.
050060 Almaty
IP Schmidt
Abayavenue 3B
110 005 Kostanay

Korea
Kyung Jin Trading CO.,LTD.
107-4, SunDuk Bld.,
YangJae-dong,
Seocho-gu,
Seoul, (zipcode: 137-891)
Phone: (+82) (0)2 574-6300

Kyrgyzstan
Alye Maki
av. Moladaya Guardir J 3
720014
Bishkek

Latvia
Husqvarna Latvija SIA
Ulbrokas 19A
LV-1021 Riga
info@gardena.lv

Lithuania
UAB Husqvarna Lietuva
Ateities pl. 77C
LT-52104 Kaunas
info@gardena.lt

Luxembourg
Magasins Jules Neuberger
39, rue Jacques Stas
Luxembourg-Gasperich 2549
Case Postale No. 12
Luxembourg 2010
Phone: (+352) 40 14 01
api@neuberger.lu

Mexico
AFOSA
Av. Lopez Mateos Sur # 5019
Col. La Calma 45070
Zapopan, Jalisco, Mexico
Phone: (+52) 33 3818-3434
icornejo@afosa.com.mx

Moldova
Convel S.R.L.
290A Muncesti Str.
2002 Chisinau

Netherlands
Husqvarna Nederland B.V.
GARDENA Division
Postbus 50131
1305 AC ALMERE
Phone: (+31) 36 521 00 10
info@gardena.nl

Neth. Antilles
Jonka Enterprises N.V.
Sta. Rosa Weg 196
P.O. Box 8200
Curaçao
Phone: (+599) 9 767 66 55
pgm@jonka.com

New Zealand
Husqvarna New Zealand Ltd.
PO Box 76-437
Manukau City 2241
Phone: (+64) (0) 9 9202410
support.nz@husqvarna.co.nz

Norway
Husqvarna Norge AS
Gardena Division
Trøskenveien 36
1708 Sarpsborg
info@gardena.no

Peru
Husqvarna Perú S.A.
Jr. Ramón Cárcamo 710
Lima 1
Tel: (+51) 1 3320400 ext. 416
juan.remuzgo@husqvarna.com

Poland
Husqvarna
Poland Spółka z o.o.
ul. Wysockiego 15 b
03-371 Warszawa
Phone: (+48) 22 330 96 00
gardena@husqvarna.com.pl

Portugal
Husqvarna Portugal, SA
Lagoa - Albarraque
2635 - 595 Rio de Mouro
Tel.: (+351) 21 922 85 30
Fax : (+351) 21 922 85 36
info@gardena.pt

Romania
Madex International Srl
Soseaua Odaii 117 - 123,
RO 013603 București, S1
Phone: (+40) 21 352.76.03
madex@ines.ro

Russia / Россия
ООО „Хускварна“
141400, Московская обл.,
г. Химки,
улица Ленинградская,
владение 39, стр.6
Бизнес Центр
„Химки Бизнес Парк“,
помещение 0B02_04
http://www.gardena.ru

Serbia
Domel d.o.o.
Autoput za Novi Sad bb
11273 Belgrade
Phone: (+381) 1 18 48 88 12
miroslav.jejina@domel.rs

Singapore
Hy-Ray PRIVATE LIMITED
40 Jalan Pemimpin
#02-08 Tat Ann Building
Singapore 577185
Phone: (+65) 6253 2277
shiyang@hyray.com.sg

Slovak Republic
Husqvarna Česko s.r.o.
Türkova 2319/5b
149 00 Praha 4 – Chodov
Bezplatná infolinie:
800 154 044
servis@sk.husqvarna.com

Slovenia
Husqvarna Austria GmbH
Industriezeile 36
4010 Linz
Tel. : (+43) 732 77 01 01-485
service.gardena@
husqvarnagroup.com

South Africa
Husqvarna
South Africa (Pty) Ltd
Postnet Suite 250
Private Bag X6,
Cascades, 3202
South Africa
Phone: (+27) 33 846 9700
info@gardena.co.za

Spain
Husqvarna España S.A.
Calle de Rivas nº 10
28052 Madrid
Phone: (+34) 91 708 05 00
atencioncliente@gardena.es

Suriname
Agrofix n.v.
Verlengde Hogestraat #22
Phone: (+597) 472426
agrofix@sr.net
Pobox : 2006
Paramaribo
Suriname – South America

Sweden
Husqvarna AB
Gardena Division
S-561 82 Huskvarna
gardenaorder@husqvarna.se

Switzerland / Schweiz
Husqvarna Schweiz AG
Consumer Products
Industriestrasse 10
5506 Mägenwil
Phone: (+41) (0) 62 887 37 90
info@gardena.ch

Turkey
Dost Bahçe Diş Ticaret
Müessesilik A.Ş
Yunus Mah. Adil Sok. No: 3
İç Kapi No: 1 Kartal
34873 İstanbul
Phone: (+90) 216 38 93 939
info@dostbahce.com.tr

Ukraine / Україна
ТОВ «Хускварна Україна»
вул. Васильківська, 34,
офіс 204-г
03022, м. Київ
Тел. (+38) 044 498 39 02
info@gardena.ua

Uruguay
FELI SA
Entre Rios 1083 CP 11800
Montevideo – Uruguay
Tel : (+598) 22 03 18 44
info@felisa.com.uy

Venezuela
Corporación Casa y Jardín C.A.
Av. Caroni, Edif. Trezmen, PB.
Colinas de Bello Monte.
1050 Caracas.
Tlf : (+58) 212 992 33 22
info@casayjardin.net.ve

1891-28.960.01/1218
© GARDENA Manufacturing GmbH
D-89070 Ulm
http://www.gardena.com