



ErgoCut 48 Art. 8875

ErgoCut 58 Art. 8876

- |            |   |            |   |
|------------|---|------------|---|
| <b>D</b>   | <b>Betriebsanleitung</b><br>Elektro-Heckenschere              | <b>GR</b>  | <b>Οδηγίες χρήσεως</b><br>Ηλεκτρικό μπορντουροψάλιδο                        |
| <b>GB</b>  | <b>Operating Instructions</b><br>Electric Hedge Trimmer       | <b>RUS</b> | <b>Инструкция по эксплуатации</b><br>Электрические кусторезы                |
| <b>F</b>   | <b>Mode d'emploi</b><br>Taille-haies électrique               | <b>SLO</b> | <b>Navodilo za uporabo</b><br>Električne škarje za živo mejo                |
| <b>NL</b>  | <b>Instructies voor gebruik</b><br>Elektrische heggenschaar   | <b>HR</b>  | <b>Upute za uporabu</b><br>Električne škare za živicu                       |
| <b>S</b>   | <b>Bruksanvisning</b><br>Elektrisk Häcksax                    | <b>SRB</b> | <b>Uputstvo za rad</b>  |
| <b>DK</b>  | <b>Brugsanvisning</b><br>Elektrisk hækkeklipper               | <b>BIH</b> | Električne makaze za živicu   |
| <b>FIN</b> | <b>Käyttöohje</b><br>Sähkökäyttöinen aitalaikkuri             | <b>UA</b>  | <b>Інструкція з експлуатації</b><br>Електричний садовий секатор             |
| <b>N</b>   | <b>Bruksanvisning</b><br>Elektrisk hekksaks                   | <b>RO</b>  | <b>Instrucțiuni de utilizare</b><br>Trimmer-ul electric de tuns garduri vii |
| <b>I</b>   | <b>Istruzioni per l'uso</b><br>Tagliasiepi elettrica          | <b>TR</b>  | <b>Kullanım Klavuzu</b><br>Elektrikli Çit Kesici                            |
| <b>E</b>   | <b>Manual de instrucciones</b><br>Recortasetos eléctrico      | <b>BG</b>  | <b>Инструкция за експлоатация</b><br>Електрически хросторез за жив плет     |
| <b>P</b>   | <b>Instruções de utilização</b><br>Tesoura eléctrica de sebes | <b>AL</b>  | <b>Manual përdorimi</b><br>Gërshërë elektronike gardhishtesh                |
| <b>PL</b>  | <b>Instrukcja obsługi</b><br>Elektryczne nożyce do żywopłotu  | <b>EST</b> | <b>Kasutusjuhend</b><br>Elektrilised hekiäärid                              |
| <b>H</b>   | <b>Használati utasítás</b><br>Elektromos sövénynyíró          | <b>LT</b>  | <b>Ekspluatavimo instrukcija</b><br>Elektrinės gyvatvorių žirklės           |
| <b>CZ</b>  | <b>Návod k použití</b><br>Elektrické nůžky na živý plot       | <b>LV</b>  | <b>Lietošanas instrukcija</b><br>Elektriskais dzīvžogu trimmeris            |
| <b>SK</b>  | <b>Návod na použitie</b><br>Elektrické nožnice na živý plot   |            |   |

# GARDENA Electric Hedge Trimmer

## ErgoCut 48 / ErgoCut 58



Translation of the original instructions from German. Please read these operating instructions carefully and observe the notes given. Use these operating instructions to familiarise yourself with the hedge trimmer, its proper use and the notes on safety.



For safety reasons, children under the age of 16 and people not familiar with these operating instructions must not use this hedge trimmer. Persons with reduced physical or mental abilities may use the hedge trimmer only if they are supervised or instructed by a responsible person.

→ Please keep these operating instructions in a safe place.

### Contents

1. Where to Use Your GARDENA Electric Hedge Trimmer	10
2. Safety Instructions	10
3. Operation	13
4. Storage	14
5. Maintenance	14
6. Troubleshooting	15
7. Accessories	15
8. Technical Data	15
9. Service/Warranty	16

## 1. Where to Use Your GARDENA Electric Hedge Trimmer

### Correct Use:

This GARDENA Electric Hedge Trimmer is intended for the cutting of hedges, shrubs and grass coverings in private domestic gardens and allotments.

Adherence to these operating instructions is a precondition for the correct use of the hedge trimmer.

### Please note



#### **WARNING ! Risk of injury!**

**The hedge trimmer must not be used for cutting lawns / lawn edges or for chopping up material for composting purposes.**

## 2. Safety Instructions



If not used properly this product can be dangerous. The warnings and safety instructions must be followed to ensure reasonable safety and efficiency in using this product. The operator is responsible for following the warnings and instructions in this manual and on the product. Never use the product unless the guards provided by the manufacturer are in the correct position.

### Explanation of Symbols on your product.



**WARNING !**



Read the user instructions carefully to make sure you understand all the controls and what they do.



Remove plug from the mains immediately if the cable is damaged or cut.



Do not expose to rain. Do not leave the product outdoors while it is raining.



The use of eye protection is recommended.

## General Power Tool Safety Warnings



**WARNING ! Read all safety warnings and all instructions.** Failure to follow the warnings and instructions may result in electric shock, fire and/or serious injury.

### Save all warnings and instructions for future reference.

The term "power tool" in the warnings refers to your mains operated (corded) power tool or battery-operated (cordless) power tool.

#### 1) Work area safety

- a) **Keep work area clean and well lit.** Cluttered or dark areas invite accidents.
- b) **Do not operate power tools in explosive atmospheres, such as in the presence of flammable liquids, gases or dust.** Power tools create sparks which may ignite the dust or fumes.
- c) **Keep children and bystanders away while operating a power tool.** Distractions can cause you to lose control.

#### 2) Electrical safety

- a) **Power tool plugs must match the outlet. Never modify the plug in any way. Do not use any adaptor plugs with earthed (grounded) power tools.** Unmodified plugs and matching outlets will reduce risk of electric shock.
- b) **Avoid body contact with earthed or grounded surfaces, such as pipes, radiators, ranges and refrigerators.** There is an increased risk of electric shock if your body is earthed or grounded.
- c) **Do not expose power tools to rain or wet conditions.** Water entering a power tool will increase the risk electric shock.
- d) **Do not abuse the cord. Never use the cord for carrying, pulling or unplugging the power tool. Keep cord away from heat, oil, sharp edges or moving parts. Damaged or entangled cords increase the risk of electric shock.**
- e) **When operating a power tool outdoors, use an extension cord suitable for outdoor use.** Use of a cord suitable for outdoor use reduces the risk of electric shock.
- f) **If operating a power tool in a damp location is unavoidable, use a residual current device (RCD) protected supply.** Use of an RCD reduces the risk of electric shock.

#### 3) Personal safety

- a) **Stay alert, watch what you are doing and use common sense when operating a power tool. Do not use a power tool while you are tired or under the influence of drugs, alcohol or medication.** A moment of inattention while operating power tools may result in serious personal injury.
- b) **Use personal protective equipment. Always wear eye protection.** Protective equipment such as dust mask, non-skid safety shoes, hard hat, or hearing protection used for appropriate conditions will reduce personal injuries.

c) **Prevent unintentional starting.** Ensure the switch is in the off-position before connecting to power source and/or battery pack, picking up or carrying the tool. Carrying power tools with your finger on the switch or energising power tools that have the switch on invites accidents.

d) **Remove any adjusting key or wrench before turning the power tool on.** A wrench or a key left attached to a rotating part of the power tools may result in personal injury.

e) **Do not overreach. Keep proper footing and balance at all times.** This enables better control of the power tool in unexpected situations.

f) **Dress properly. Do not wear loose clothing or jewellery. Keep your hair, clothing and gloves away from moving parts.** Loose clothes, jewellery or long hair can be caught in moving parts.

g) **If devices are provided for the connection of dust extraction and collection facilities, ensure these are connected and properly used.** Use of dust collection can reduce dust-related hazards.

#### 4) Power tool use and care

- a) **Do not force the power tool. Use the correct power tool for your application.** The correct power tool will do the job better and safer at the rate for which it was designed.
- b) **Do not use the power tool if the switch does not turn it on and off.** Any power tool that cannot be controlled with the switch is dangerous and must be repaired.
- c) **Disconnect the plug from the power source and/or the battery pack from the power tool before making any adjustments, changing accessories, or storing power tools.** Such preventive safety measures reduce the risk of starting the power tool accidentally.
- d) **Store idle power tools out of the reach of children and do not allow persons unfamiliar with the power tool or these instructions to operate the power tool.** Power tools are dangerous in the hands of untrained users.
- e) **Maintain power tools.** Check for misalignment or binding of moving parts, breakage of parts and any other condition that may affect the power tool's operation. If damaged, have the power tool repaired before use. Many accidents are caused by poorly maintained power tools.
- f) **Keep cutting tools sharp and clean.** Properly maintained cutting tools with sharp cutting edges are less likely to bind and are easier to control.
- g) **Use the power tool, accessories and tool bits etc. in accordance with these instructions, taking into account the working conditions and the work to be performed.** Use of the power tool for operations different from those intended could result in a hazardous situation.

## 5. Service

Have your power tool serviced by a qualified repair person using only identical replacement parts. This will ensure that the safety of the power tool is maintained.

### Hedge trimmer safety warnings:

- **Keep all parts of the body away from the cutter blade. Do not remove cut material or hold material to be cut when blades are moving. Make sure the switch is off when clearing jammed material.** A moment of inattention while operating the hedge trimmer may result in serious personal injury.
- **Carry the hedge trimmer by the handle with the cutter blade stopped. When transporting or storing the hedge trimmer always fit the cutting device cover.** Proper handling of the hedge trimmer will reduce possible personal injury from the cutter blades.
- **Hold the power tool by insulated gripping surfaces only, because the cutter blade may contact hidden wiring or its own cord.** Cutter blades contacting a "live" wire may make exposed metal parts of the power tool "live" and could give the operator an electric shock.
- **Keep cable away from the cutting area.** During operation the cable may be hidden in shrubs and can be accidentally cut by the blade.

### Additional Safety Recommendations

#### **Work area safety**

Only use the product in the manner and for the functions described in these instructions.

The operator or user is responsible for accidents or hazards occurring to other people or their property.

#### **Electrical safety**

The British Standards Institute recommend the use of a Residual Current Device (R.C.D.) with a tripping current of not more than 30 mA. Check your R.C.D. every time you use it.

Before use, examine cable for damage, replace it if there are signs of damage or ageing.

Do not use the product if the electric cables are damaged or worn.

Immediately disconnect from the mains electricity supply if the cable is cut, or the insulation is damaged. Do not touch the electric cable until the electrical supply has been disconnected.

Your electric cable must be untangled, tangled cables can overheat and reduce the efficiency of your product.

Always switch off at the mains before disconnecting any plug, cable connector or extension cable.

Switch off, remove plug from mains and examine electric supply cable for damage or ageing before winding cable for storage. Do not repair a damaged cable, replace it with a new one.

Always wind cable carefully, avoiding kinking.

Use only on AC mains supply voltage shown on the product rating label.

Under no circumstances should an earth be connected to any part of the product.

## Cables

Use only permitted extension cables as per HD 516.

→ Ask your electrical specialist.

### Personal safety

Always wear suitable clothing, gloves, and stout shoes.

Thoroughly inspect the area where the product is to be used and remove all wires and other foreign objects.

Before using the machine and after any impact, check for signs of wear or damage and repair as necessary.

Never attempt to use an incomplete product or one with an unauthorised modification.

### Power tool use and care

Know how to stop the product quickly in an emergency.

Never hold the product by the guard.

Do not use the Hedge Trimmer if the protection equipment (hand protection, 2-hand safety switch, protection cover, quick blade-stop) are damaged.

Do not use ladders whilst operating the product.

Remove the plug from the mains :

- before leaving the product unattended for any period;
- before clearing a blockage;
- before checking, cleaning or working on the appliance;
- if you hit an object. Do not use your product until you are sure that the entire product is in a safe operating condition;
- if the product starts to vibrate abnormally. Check immediately. Excessive vibration can cause injury.
- before passing to another person.

### Maintenance and storage



#### **RISK OF INJURY !**

**Do not touch blades.**

→ **When finishing or interrupting work push up protection cover.**

Keep all nuts, bolts and screws secure to be sure the hedge trimmer is in safe working condition.

## 3. Operation

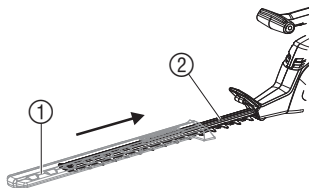

### DANGER ! Risk of physical injury!

- Always disconnect the extension cable ④ from the mains and slide the protective cover ① over the trimmer blade ② before connecting.
- Never take hold of the protective cover ① when connecting the hedge trimmer.

### Connecting the Hedge Trimmer:

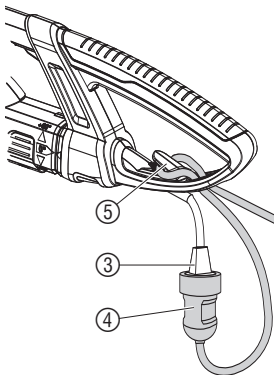

### DANGER ! Risk of electric shock!

To avoid damage to the the mains cord ③ the extension cable ④ must be inserted into the cable lock ⑤.

- Always insert the extension cable ④ into the cable lock ⑤.

1. Loop the extension cable ④, insert the loop into the cable lock ⑤ and pull tight.
2. Insert the plug of the mains cord ③ into the socket of the extension cable ④.
3. Plug the extension cable ④ into a 230 V mains power supply.

### Working positions:

The hedge trimmer can be operated in 3 working positions.

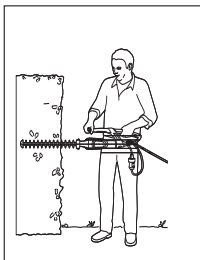

**Side trimming:**  
Cutting unit in 90° position

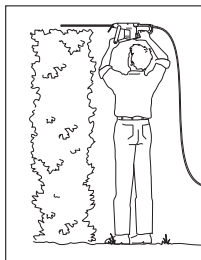

**High trimming:**  
0° position

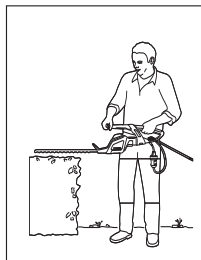

**Low trimming:**  
0° position

### Rotate cutting unit through 90°:

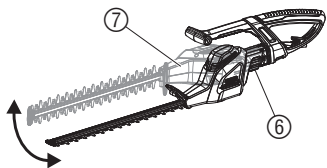

For sideways cutting, the cutting unit can be rotated through 90°. The cutting unit ⑦ can be turned to the right or left for right-handed or left-handed users respectively.

1. Disconnect mains plug.
2. Keep button ⑥ pressed.
3. Turn cutting unit ⑦ 90° in the required direction until the button ⑥ locks into place.

A safety device prevents the Hedge Trimmer from starting up when the button ⑥ is pressed or not locked in 0° or 90° position.

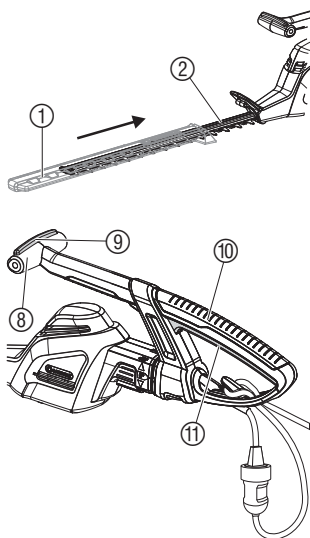
**Starting the Hedge Trimmer:**

**DANGER ! Risk of physical injury!**  
 If the Hedge Trimmer does not switch off automatically, there is a risk of lacerations.  
 → Never override the safety devices (e.g. by strapping down one of the start buttons).

**Starting the Hedge Trimmer:**

The hedge trimmer is fitted with a two-handed safety device (2 start buttons) to prevent the unit from being turned on by accident.

1. Remove the protective cover ① from blade.
2. Hold the guide handle ⑧ with one hand and press the start button ⑨.
3. Hold the main handle ⑩ with the other hand and press the start button ⑪.

*The hedge trimmer will start.*

**Switching the Hedge Trimmer off:**

1. Release the two start buttons ⑨ / ⑪.
2. Slide the protective cover ① over the cutter blade ②.

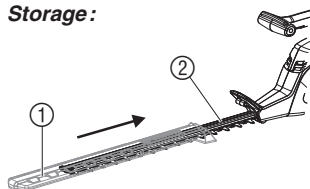
**4. Storage****Storage:**

The hedge trimmer must be stored out of the reach of children.

1. Disconnect the mains plug.
2. Clean the hedge trimmer (see 5. Maintenance) and slide the protective cover ① over the cutter blade ②.
3. Store the hedge trimmer in a dry, frost free place.

**Disposal:**

(in accordance with  
 RL2002/96/EC)

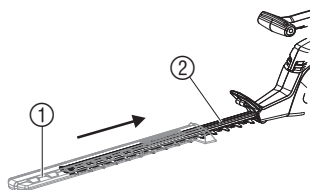

The product must not be added to normal household waste. It must be disposed of in line with local environmental regulations.  
 → Important: Make sure that the unit is disposed of via your municipal recycling collection centre.

**5. Maintenance****Cleaning the Hedge Trimmer:**

**DANGER ! Risk of physical injury / electric shock!**  
 → Always unplug the mains plug and slide the protective cover ① over the cutter blade ② before carrying out maintenance work.  
 → Do not clean the hedge trimmer under running water (especially high pressure).

1. Clean the hedge trimmer with a damp cloth.
2. Lubricate the trimmer blade ② with a low viscosity oil (e.g. GARDENA spray-oil Art. 2366). Avoid contact with the plastic parts.

## 6. Troubleshooting



**DANGER ! Electric shock!**

→ Always unplug the mains plug and slide the protective cover ① over the cutter blade ② before troubleshooting.

Fault	Possible Cause	Remedy
Hedge trimmer does not start	Extension cable not plugged in or is damaged.	→ Plug in the extension cable or if necessary replace it.
	Cutting unit not locked in 0° or 90° position.	→ Lock cutting unit in 0° or 90° position.
Hedge is not cleanly cut	Blade blunt or damaged.	→ Have blade replaced by GARDENA-Service.



In the event of other faults please contact GARDENA Service.

Repairs should only be carried out by GARDENA service centres or dealers authorised by GARDENA.

## 7. Accessories

GARDENA Maintenance Oil	Extends the life of the blade.	Art. 2366
-------------------------	--------------------------------	-----------

## 8. Technical Data

	ErgoCut 48 (Art. 8875)	ErgoCut 58 (Art. 8876)
Power consumption, motor	550 W	550 W
Voltage / Frequency	230 V / 50 Hz	230 V / 50 Hz
Strokes	2,800/min.	2,800/min.
Length of cutter blade	48 cm	58 cm
Tooth gap of cutter blade	27 mm	27 mm
Weight	3.7 kg	3.8 kg
Workplace related sound pressure level $L_{pA}$ 1)	84 dB (A)	85 dB (A)
Uncertainty $K_{pA}$	3 dB (A)	3 dB (A)
Noise emission value $L_{WA}$ 2)	measured 94 dB (A) / guaranteed 95 dB (A)	measured 95 dB (A) / guaranteed 96 dB (A)
Hand/arm vibration $a_{vhw}$ 1)	< 2.5 m/s <sup>2</sup>	

Measuring process complying with 1) EN 774 2) EU-directive 2000/14/EC. The stated vibration emission value has been measured according to a standardised test procedure and can be used for comparison of one electric power tool with another. It can also be used for preliminary evaluation of exposure. The vibration emission value can vary during actual use of the electric power tool.

## 9. Service / Warranty

---

GARDENA guarantees this product for 2 years (from date of purchase). This guarantee covers all serious defects of the unit that can be proved to be material or manufacturing faults. Under warranty we will either replace the unit or repair it free of charge if the following conditions apply:

- The unit must have been handled properly and in keeping with the requirements of the operating instructions.
- Neither the purchaser nor a non-authorized third party have attempted to repair the unit.

The blade and eccentric drive are wearing parts and are not covered by the guarantee.

This manufacturer's guarantee does not affect the user's existing warranty claims against the dealer / seller.

If a fault occurs with your hedge trimmer, please return the faulty unit together with the receipt and a description of the fault, with postage paid to the address of the Service Centre at the back of these operating instructions.



## **D Produkthaftung**

Wir weisen ausdrücklich darauf hin, dass wir nach dem Produkthaftungsgesetz nicht für durch unsere Geräte hervorgerufene Schäden einzustehen haben, sofern diese durch unsachgemäße Reparatur verursacht oder bei einem Teileaustausch nicht unsere Original GARDENA Teile oder von uns freigegebene Teile verwendet werden und die Reparatur nicht vom GARDENA Service oder dem autorisierten Fachmann durchgeführt wird. Entsprechendes gilt für Ergänzungsstücke und Zubehör.

## **GB Product Liability**

We expressly point out that, in accordance with the product liability law, we are not liable for any damage caused by our units if it is due to improper repair or if parts exchanged are not original GARDENA parts or parts approved by us, and, if the repairs were not carried out by a GARDENA Service Centre or an authorised specialist. The same applies to spare parts and accessories.

## **F Responsabilité**

Nous vous signalons expressément que GARDENA n'est pas responsable des dommages causés par ses appareils, dans la mesure où ces dommages seraient causés suite à une réparation non conforme, dans la mesure où, lors d'un échange de pièces, les pièces d'origine GARDENA n'auraient pas été utilisées, ou si la réparation n'a pas été effectuée par le Service Après-Vente GARDENA ou l'un des Centres SAV agréés GARDENA. Ceci est également valable pour tout ajout de pièces et d'accessoires autres que ceux préconisés par GARDENA.

## **NL Productaansprakelijkheid**

Wij wijzen er nadrukkelijk op, dat wij op grond van de wet aansprakelijkheid voor producten niet aansprakelijk zijn voor schade ontstaan door onze apparaten, indien deze door onvakkundige reparatie veroorzaakt zijn, of er bij het uitwisselen van onderdelen geen gebruik gemaakt werd van onze originele GARDENA onderdelen of door ons vrigegeven onderdelen en de reparatie niet door de GARDENA technische dienst of de bevoegde vakman uitgevoerd werd. Ditzelfde geldt voor extra-onderdelen en accessoires.

## **S Produktansvar**

Tillverkaren är inte ansvarig för skada som orsakats av produkten om skadan beror på att produkten har reparats felaktigt eller om, vid reparation eller utbyte, andra än Original GARDENA reservdelar har använts. Samma sak gäller för kompletteringsdelar och tillbehör.

## **DK Produktansvar**

Vi gør udtrykkeligt opmærksom på at i henhold til produktansvarsloven er vi ikke ansvarlige for skader forårsaget af vores udstyr, hvis det skyldes uautoriserede reparationer eller hvis dele er skiftet ud og der ikke er anvendt originale GARDENA dele eller dele godkendt af os, eller hvis reparationerne ikke er udført af GARDENA-service eller en autoriseret fagmand. Det samme gælder for ekstra udstyr og tilbehør.

## **FIN Tuotevastuu**

Korostamme nimenomaan, että tuotevastuulain nojalla emme ole vastuussa laitteistamme johtuneista vahingoista, mikäli nämä ovat aiheutuneet epäasianmukaisesta korjauksesta tai osia vaihdettaessa ei ole käytetty alkuperäisiä GARDENA- varaosia tai hyväksymämme osia ja korjauksen on suorittanut muu kuin GARDENA -huoltokeskus tai valtuuttamamme ammattihenkilö. Tämä pätee myös lisäosiin ja lisävarusteisiin.

## **I Responsabilità del prodotto**

Si rende espressamente noto che, conformemente alla legislazione sulla responsabilità del prodotto, non si risponde di danni causati da nostri articoli se originati da riparazioni eseguite non correttamente o da sostituzioni di parti effettuate con materiale non originale GARDENA o comunque da noi non approvato e, in ogni caso, qualora l'intervento non venga eseguito da un centro assistenza GARDENA o da personale specializzato autorizzato. Lo stesso vale per le parti complementari e gli accessori.

## **E Responsabilidad de productos**

Advertimos que conforme a la ley de responsabilidad de productos no nos responsabilizamos de daños causados por nuestros aparatos, siempre y cuando dichos daños hayan sido originados por arreglos o reparaciones indebidas, por recambios con piezas que no sean piezas originales GARDENA o bien piezas autorizadas por nosotros, así como en aquellos casos en que la reparación no haya sido efectuada por un Servicio Técnico GARDENA o por un técnico autorizado. Lo mismo es aplicable para las piezas complementarias y accesorios.

## **P Responsabilidade sobre o produto**

Queremos salientear que segundo a lei da responsabilidade do fabricante, nós não nos responsabilizaremos por danos causados pelo nosso equipamento, quando estes ocorrerem em decorrência de reparações inadequadas ou da substituição de peças por peças não originais da GARDENA, ou peças não autorizadas. A responsabilidade tornar-se-à nula também depois de reparações realizadas por oficinas não autorizadas pela GARDENA. Esta restrição valerá também para peças adicionais e acessórios.

<p><b>D EG-Konformitätserklärung</b></p> <p>Der Unterzeichnete Husqvarna AB, 561 82 Huskvarna, Sweden bestätigt, dass die nachfolgend bezeichneten Geräte in der von uns in Verkehr gebrachten Ausführung die Anforderungen der harmonisierten EU-Richtlinien, EU-Sicherheitsstandards und produktspezifischen Standards erfüllen. Bei einer nicht mit uns abgestimmten Änderung der Geräte verliert diese Erklärung ihre Gültigkeit.</p>	<p><b>H EU azonososági nyilatkozat</b></p> <p>Alulírott, Husqvarna AB, 561 82 Huskvarna, Sweden, igazolja, hogy az alább felsorolt, általunk forgalomba hozott termékek megfelelnek az EU elvárásoknak, EU biztonsági normáknak és a termékspecifikus szabványoknak egyaránt. A készülék velünk nem egyeztetett változtatása esetén ez a nyilatkozat érvényét veszti.</p>
<p><b>GB EU Declaration of Conformity</b></p> <p>The undersigned Husqvarna AB, 561 82 Huskvarna, Sweden, hereby certifies that, when leaving our factory, the units indicated below are in accordance with the harmonised EU guidelines, EU standards of safety and product specific standards. This certificate becomes void if the units are modified without our approval.</p>	<p><b>CZ ES Prohlášení o shodě</b></p> <p>Niže podpešpaná společnost Husqvarna AB, 561 82 Huskvarna, Sweden, potvrzuje, že níže označený přístroj v provedení, který jsme uvedli na trh, splňuje požadavky uvedené v harmonizovaných směrnici EU, v bezpečnostních standardech EU a ve standardech pro daný produkt. V případě změny přístroje, která námi nebyla odsouhlasena, ztrácí toto prohlášení platnost.</p>
<p><b>F Certificat de conformité aux directives européennes</b></p> <p>Le constructeur, soussigné : Husqvarna AB, 561 82 Huskvarna, Sweden, déclare qu'à la sortie de ses usines le matériel neuf désigné ci-dessous étai conforme aux prescriptions des directives européennes énoncées ci-après et conforme aux règles de sécurité et autres règles qui lui sont applicables dans le cadre de l'Union européenne. Toute modification portée sur ce produit sans l'accord express de Husqvarna supprime la validité de ce certificat.</p>	<p><b>SK ES Vyhlasenie o zhode</b></p> <p>Dolu podpísaná spoločnosť Husqvarna AB, 561 82 Huskvarna, Sweden, potvrdzuje, že ďalej označený prístroj vo vyhotovení nami uvedenom do prevádzky spĺňa požiadavky harmonizovaných smerníc EU, bezpečnostných štandardov EU a štandardov špecifických pre produkt. V prípade zmeny prístroja, ktorá nebola nami odsúhlasená, stráca toto vyhlásenie platnosť.</p>
<p><b>NL EU-overeenstemmingsverklaring</b></p> <p>Ondergetekende Husqvarna AB, 561 82 Huskvarna, Sweden, bevestigt, dat het volgende genoemde apparaat in de door ons in de handel gebrachte uitvoering voldoet aan de eis van, en in overeenstemming is met de EU-richtlijnen, de EU-veiligheidsstandaard en de voor het product specifieke standaard. Bij een niet met ons afgestemde verandering aan het apparaat verliest deze verklaring haar geldigheid.</p>	<p><b>GR Πιστοποιητικό συμμόρφωσης ΕΚ</b></p> <p>Η υπογεγραμμένη : Husqvarna AB, 561 82 Huskvarna, Sweden πιστοποιεί ότι τα μηχανήματα που υποδεικνύονται κάτωθι, όταν φεύγουν από το εργοστάσιο, είναι κατασκευασμένα σύμφωνα με τις οδηγίες της Ευρωπαϊκής Κοινότητας, τα Κοινωνικά πρότυπα ασφαλείας και τις προδιαγραφές. Αυτό το πιστοποιητικό δεν ισχύει σε περίπτωση που τα προϊόντα τροποποιηθούν χωρίς την έγκρισή μας.</p>
<p><b>S EU Tillverkarintyg</b></p> <p>Undertecknad firma Husqvarna AB, 561 82 Huskvarna, Sweden, intygar härmed att nedan nämnda produkter överensstämmer med EU:s direktiv, EU:s säkerhetsstandard och produktspecifikation. Detta intyg upphör att gälla om produkten ändras utan vårt tillstånd.</p>	<p><b>SLO Izjava o skladnosti s pravili EU</b></p> <p>Podpisano podjetje, Husqvarna AB, 561 82 Huskvarna, Sweden, potrjuje, da v nadaljevanju navedena naprava v različici, ki smo jo poslali na trg, izpolnjuje zahteve smernic EU, varnostnih standardov EU in standardov tovrstnih proizvodov. Izjava ne velja za spremembe na napravi, ki niso opravljene v soglasju z nami.</p>
<p><b>DK EU Overensstemmelse certifikat</b></p> <p>Undertegnede Husqvarna AB, 561 82 Huskvarna, Sweden bekræfter hermed, at enheder listet herunder, ved afsendelse fra fabrikken, er i overensstemmelse med harmoniserede EU retningslinjer, EU sikkerhedsstandarder og produkt-specifikationsstandarder. Dette certifikat træder ud af kraft hvis enhederne er ændret uden vor godkendelse.</p>	<p><b>RO UE - Certificat de conformitate</b></p> <p>Prin prezenta Husqvarna AB, 561 82 Huskvarna, Sweden, certifica faptul ca, in momentul in care produsele mentionate mai jos ies din fabrica sunt in concordanta cu directivele UE, standardele de siguranta UE si standardele specifice ale produsului UE. Acest certificat devine nul in cazul modificarii aparatului fara aprobarea noastra.</p>
<p><b>FIN EY-vaatimustenmukaisuusvakuutus</b></p> <p>Allekirjoittanut Husqvarna AB, 561 82 Huskvarna, Sweden vakuuttaa, että allamainittu laitteet täyttävät tehtaaltamme lähtessään yhdenmukaistettujen EY-direktiivien, EY-turvallisuusstandardien ja tuotekohtaisten standardien vaatimukset. Laitteisiin tehdyt muutokset, joista ei ole sovittu kanssamme, johtavat tämän vakuutuksen raukaamiseen.</p>	<p><b>BG ЕС-Декларация за съответствие</b></p> <p>Подписаната фирма Husqvarna AB, 561 82 Huskvarna, Sweden декларира, че описаните подолу уреди, пуasnати в продажба съгласно нашата спецификация, изпълняват изискванията на хармонизираните ЕС-директиви, ЕС-станданти за безопасност и специфичните производствени стандарти. При промяна на уреда, която не е съгласувана с нас, тази декларация губи своята валидност.</p>
<p><b>I Dichiarazione di conformità alle norme UE</b></p> <p>La sottoscritta Husqvarna AB, 561 82 Huskvarna, Sweden, certifica che il prodotto qui di seguito indicato, nei modelli da noi commercializzati, è conforme alle direttive armonizzate UE nonché agli standard di sicurezza e agli standard specifici di prodotto. Qualunque modifica apportata al prodotto senza nostra specifica autorizzazione invalida la presente dichiarazione.</p>	<p><b>EST ELi vastavusdeklaratsioon</b></p> <p>Allakirjutatu Husqvarna AB, 561 82 Huskvarna, Sweden kinnitab, et kirjeldatud seade vastab meie poolt ringlusse viidud kujul ELi harmoniseeritud direktiividele, ELi ohutusstandarditele ja tootega seotud standarditele. Meiega kooskõlastamata muudatuse tegemise korral seadmel kaotab see deklaratsioon kehtivuse.</p>
<p><b>E Declaración de conformidad de la UE</b></p> <p>El que suscribe Husqvarna AB, 561 82 Huskvarna, Sweden, declara que la presente mercancía, objeto de la presente declaración, cumple con todas las normas de la UE, en lo que a normas técnicas, de homologación y de seguridad se refiere. En caso de realizar cualquier modificación en la presente mercancía sin nuestra previa autorización, esta declaración pierde su validez.</p>	<p><b>LT ES Atitikties deklaracija</b></p> <p>Pasirašanti Husqvarna AB, 561 82 Huskvarna, Sweden patvirtina, kad žemiau nurodyti prietaisai ir jų modeliai, kuriuos paleidome į apyvartą, patenkinia harmonizuotas ES direktyvas, ES saugumo standartus ir specifinius gaminio standartus. Atlikus bet kokį prietaiso pakeitimą, kuris nėra suderintas su mumis, ši deklaracija praranda galiojimą.</p>
<p><b>P Certificado de conformidade da UE</b></p> <p>Os abaixo mencionados Husqvarna AB, 561 82 Huskvarna, Sweden, por este meio certificam que ao sair da fábrica o aparelho abaixo mencionado está de acordo com as diretrizes harmonizadas da UE, padrões de segurança e de produtos específicos. Este certificado ficará nulo se a unidade for modificada sem a nossa aprovação.</p>	<p><b>LV ES-atbilstības deklarācija</b></p> <p>Parakstījusies Husqvarna AB, 561 82 Huskvarna, Sweden, Vācija apstiprina, ka sekojoši apzīmētās iekārtas, kuras mēs izplatām, savā izpildījumā atbilst harmonizētajām ES direktīvām, ES drošības standartiem un produkta specifiskajiem standartiem. Ar mūsu neapstiprinātām izmaiņām iekārtā šī deklarācija zaudē savu derīgumu.</p>
<p><b>PL Deklaracja zgodności Unii Europejskiej</b></p> <p>Niżej podpisany Husqvarna AB, 561 82 Huskvarna, Sweden, potwierdza, że poniżej opisane urządzenie w wykonaniu wprowadzonym przez nas do obrotu spełnia wymogi zharmonizowanych wytycznych Unii Europejskiej, standardów bezpieczeństwa Unii Europejskiej i standardów specyficznych dla danego produktu. W przypadku wprowadzenia zmian nie uzgodnionych z nami wyjaśnienie to traci swoją ważność.</p>	



**Deutschland / Germany**

**GARDENA GmbH**  
Central Service  
Hans-Lorenser-Straße 40  
D-89079 Ulm  
Produktfragen:  
(+49) 731 490-123  
Reparaturen:  
(+49) 731 490-290  
service@gardena.com

**Albania**

**COBALT Sh.p.k.**  
Rr. Siri Kodra  
1000 Tirana  
**Argentina**  
Husqvarna Argentina S.A.  
Av.del Libertador 5954 –  
Piso 11 – Torre B  
(C1428ARP) Buenos Aires  
Phone: (+54) 11 5194 5000  
info.gardena@  
ar.husqvarna.com

**Armenia**

Garden Land Ltd.  
61 Tigran Mets  
0005 Yerevan

**Australia**

Husqvarna Australia Pty. Ltd.  
Locked Bag 5  
Central Coast BC  
NSW 2252  
Phone: (+61) (0) 2 4352 7400  
customer.service@  
husqvarna.com.au

**Austria / Österreich**

Husqvarna Austria GmbH  
Consumer Products  
Industriezeile 36  
4010 Linz  
Tel.: (+43) 732 77 01 01-90  
consumer.service@  
husqvarna.at

**Azerbaijan**

Firm Progress a.  
Aliyev Str. 26A  
10522 Baku

**Belgium**

GARDENA Belgium NV/SA  
Sterrebeekstraat 163  
1930 Zaventem  
Phone: (+32) 2 720 92 12  
Mail: info@gardena.be

**Bosnia / Hercegovina**

**SILK TRADE d.o.o.**  
Industrijska zona Bukva bb  
74260 Tešanj

**Brazil**

Husqvarna do Brasil Ltda  
Av. Francisco Matrazzo,  
1400 – 19º andar  
São Paulo – SP  
CEP: 05001-903  
Tel: 0800-112252  
marketing.br.husqvarna@  
husqvarna.com.br

**Bulgaria**

Хускварна България ЕООД  
Бул. „Андрей Липчев“ № 72  
1799 София  
Tel.: (+359) 02/9753076  
www.husqvarna.bg

**Canada / USA**

GARDENA Canada Ltd.  
100 Summerlea Road  
Brampton, Ontario L6T 4X3  
Phone: (+1) 905 792 9330  
info@gardena.ca

**Chile**

Maquinarias Agroforestales  
Ltda. (Maga Ltda.)  
Santiago, Chile  
Avda. Chesterton  
# 8355 comuna Las Condes  
Phone: (+56) 2 202 4417  
Dalton@magla.cl  
Zipcode: 7560330

**Temuco, Chile**

Avda. Valparaiso # 01466  
Phone: (+56) 45 222 126  
Zipcode: 4780441

**China**

Husqvarna (China) Machinery  
Manufacturing Co., Ltd.  
No. 1355, Jia Xin Rd.  
Ma Lu Zhen, Jia Ding Dist.,  
Shanghai  
201801  
Phone: (+86) 21 59159629  
Domestic Sales  
www.gardena.com.cn

**Colombia**

Husqvarna Colombia S.A.  
Calle 18 No. 68 D-31, zona  
Industrial de Montevideo  
Bogotá, Cundinamarca  
Tel. 571 2922700 ext. 105  
jairo.salazar@  
husqvarna.com.co

**Costa Rica**

Compania Exim  
Euroiberoamericana S.A.  
Los Colegios, Mosca,  
200 metros al Sur del Colegio  
Saint Francis – San José  
Phone: (+506) 297 68 83  
exim\_euro@racsa.co.cr

**Croatia**

**SILK ADRIA d.o.o.**  
Josipa Lončara 3  
10090 Zagreb  
Phone: (+385) 1 3794 580  
silk.adria@zg-t-com.hr

**Cyprus**

Med Marketing  
17 Digeni Akritas Ave  
P.O. Box 27017  
1641 Nicosia

**Czech Republic**

Husqvarna Česko s.r.o.  
Türkova 2319/5b  
149 00 Praha 4 – Chodov  
Bezplatná infolinika:  
800 100 425  
servis@cz.husqvarna.com

**Denmark**

GARDENA / Husqvarna  
Consumer Outdoor Products  
Salgsafdelning Danmark  
Box 9003  
S-200 39 Malmö  
info@gardena.dk

**Dominican Republic**

**BOSQUESA, S.R.L.**  
Carretera Santiago Licey  
Km. 5 ½  
Esquina Copal II.  
Santiago, Dominican Republic  
Phone: (+809) 736-0333  
joserbosquesa@claro.net.do

**Ecuador**

Husqvarna Ecuador S.A.  
Arujos E1-181 y 10 de Agosto  
Quito, Pichincha  
Tel: (+593) 22800739  
francisco.jacom@  
husqvarna.com.ec

**Estonia**

Husqvarna Eesti OÜ  
Consumer Outdoor Products  
Kesk tee 10, Aaviku küla  
Rae vald  
Harju maakond  
75005 Estonia  
kontakt.etj@husqvarna.ee

**Finland**

Oy Husqvarna Ab  
Consumer Outdoor Products  
Lauttarhankatu 8 B / PL 3  
00581 HELSINKI  
info@gardena.fi

**France**

GARDENA France  
Immelle Expositiel  
9-11 allée des Pierres Mayettes  
ZAC des Barbanniers, B.P. 99  
-F- 92232 GENNEVILLIERS  
cedex  
Tél. (+33) 01 40 85 30 40  
service.consommateurs@  
gardena.fr

**Georgia**

AJD Group  
Belashvili 8  
1159 Tbilisi

**Great Britain**

Husqvarna UK Ltd  
Preston Road  
Aycliffe Industrial Park  
Newton Aycliffe  
County Durham  
DL5 6UP  
info.gardena@  
husqvarna.co.uk

**Greece**

**HUSQVARNA ΕΛΛΑΣ Α.Ε.Β.Ε.**  
Υπ. /μ Ηρόδιου 33Α  
Βλ. Πλ. Κορωπίου  
194 00 Κορωπί Αττικής  
V.A.T. EL094094640  
Phone: (+30) 210 6620 225  
info@husqvarna-consumer.gr

**Hungary**

Husqvarna Magyarorszáig Kft.  
Ezred u. 1-3  
1044 Budapest  
Telephone: (+36) 1 251-4161  
vevozsolgalat.husqvarna@  
husqvarna.hu

**Iceland**

O. Johnson & Kaaber  
Tunguhalsi 1  
110 Reykjavik  
ooj@oik.is

**Ireland**

Husqvarna UK Ltd  
Preston Road  
Aycliffe Industrial Park  
Newton Aycliffe  
County Durham  
DL5 6UP  
info.gardena@  
husqvarna.co.uk

**Italy**

Husqvarna Italia S.p.A.  
Via Como 72  
23868 VALMADRERA (LC)  
Phone: (+39) 0341.203.111  
info@gardenaitalia.it

**Japan**

KAKIUCHI Co. Ltd.  
Sumitomo Realty &  
Development Kojimachi  
BLDG., 8F  
5-1 Nibanncyo  
Chiyoda-ku  
Tokyo 102-0084  
Phone: (+81) 33 264 7271  
m\_ishihara@kaku-ichi.co.jp

**Kazakhstan**

LAMED Ltd.  
155/11, Tazhibayevy Str.  
050060 Almaty  
IP Schmidt  
Abayavenue 3B  
110 005 Kostanay

**Kyrgyzstan**

Alye Maki  
av. Molodaya Guardir J 3  
720014  
Bishkek

**Latvia**

Husqvarna Latvija  
Consumer Outdoor Products  
Bākuži iela 6  
LV-1024 Rīga  
info@husqvarna.lv

**Lithuania**

UAB Husqvarna Lietuva  
Consumer Outdoor Products  
Ateities pl. 77C  
LT-52104 Kaunas  
centras@husqvarna.lt

**Luxembourg**

Magasins Jules Neuberg  
39, rue Jacques Stas  
Luxembourg-Gasperich 2549  
Case Postale No.12  
Luxembourg 2010  
Phone: (+352) 40 14 01  
api@neuberg.lu

**Mexico**

**AFOSA**  
Av. Lopez Mateos Sur # 5019  
Col. La Calma 45070  
Zapopan, Jalisco  
Mexico  
Phone: (+52) 33 3818-3434  
icornejo@afosa.com.mx

**Moldova**

Convel S.R.L.  
290A Muncesti Str.  
2002 Chisinau

**Netherlands**

**GARDENA Nederland B.V.**  
Postbus 50176  
1305 AD ALMERE  
Phone: (+31) 36 521 00 00  
info@gardena.nl

**Neth. Antilles**

Jonka Enterprises N.V.  
Sta. Rosa Weg 196  
P.O. Box 8200  
Curaçao  
Phone: (+599) 9 767 66 55  
pgm@jonka.com

**New Zealand**

Husqvarna New Zealand Ltd.  
PO Box 76-437  
Manukau City 2241  
Phone: (+64) (0) 9 9202410  
support.nz@husqvarna.co.nz

**Norway**

GARDENA  
Husqvarna Consumer  
Outdoor Products  
Salgskontor Norge  
Klevereivn 6  
1540 Vestby  
info@gardena.no

**Peru**

Husqvarna Perú S.A.  
Jr. Ramón Cárcamo 710  
Lima 1  
Tel: (+51) 1 3320400 ext. 416  
juan\_remuigo@  
husqvarna.com

**Poland**

Husqvarna  
Poland Spółka z o.o.  
ul. Wysockiego 15 b  
03-371 Warszawa  
Phone: (+48) 22 330 96 00  
gardena@husqvarna.com.pl

**Portugal**

Husqvarna Portugal, SA  
Lagoa - Albarraque  
2635 - 595 Rio de Mouro  
Tel.: (+351) 21 922 85 30  
Fax: (+351) 21 922 85 36  
info@gardena.pt

**Romania**

Madex International Srl  
Soseaua Odaii 117-123,  
RO 013603  
București, S 1  
Phone: (+40) 21 352.76.03  
madex@mes.ro

**Russia**

ООО „Хускварна“  
141400, Московская обл.,  
г. Химки,  
улица Ленинградская,  
владение 39, стр.6  
Бизнес Центр  
„Химки Бизнес Парк“,  
помещение ОВ02\_04

**Serbia**

Domel d.o.o.  
Autoput za Novi Sad bb  
11273 Belgrade  
Phone: (+381) 11 848 88 12  
mirosavljevina@domel.rs

**Singapore**

Hy-Ray PRIVATE LIMITED  
40 Jalan Pemimpin  
02-08 Tat Ann Building  
Singapore 577185  
Phone: (+65) 6253 2277  
shiyang@hyray.com.sg

**Slovak Republic**

Husqvarna Česko s.r.o.  
Türkova 2319/5b  
149 00 Praha 4 – Chodov  
Bezplatná infolinika:  
800 154 044  
servis@sk.husqvarna.com

**Slovenia**

Husqvarna Austria GmbH  
Consumer Products  
Industriezeile 36  
4010 Linz  
Tel.: (+43) 732 77 01 01-90  
consumer.service@  
husqvarna.at

**South Africa**

Husqvarna  
South Africa (Pty) Ltd  
Postnet Suite 250  
Private Bag X6,  
Cascades, 3202  
South Africa  
Phone: (+27) 33 846 9700  
info@gardena.co.za

**Spain**

Husqvarna España S.A.  
C/ Basauri, nº 6  
La Florida  
28023 Madrid  
Phone: (+34) 91 708 05 00  
atencioncliente@gardena.es

**Suriname**

Agrofix n.v.  
Verlengde Hogestraat #22  
Phone: (+597) 472426  
agrofix@sr.net  
Pobox : 2006  
Paramaribo  
Suriname – South America

**Sweden**

Husqvarna AB  
S-561 82 Huskvarna  
info@gardena.se

**Switzerland / Schweiz**

Husqvarna Schweiz AG  
Consumer Products  
Industriestrasse 10  
5506 Mägenwil  
Phone: (+41) (0) 848 800 464  
info@gardena.ch

**Turkey**

GARDENA Dost Diş Ticaret  
Minesilikli A.Ş.  
Sanayi Cad. Adil Sokak  
No: 1/B Kartal  
34873 Istanbul  
Phone: (+90) 216 3893939  
info@gardena-dost.com.tr

**Ukraine / Україна**

ТОВ «Хусарна Україна»  
вул. Васильківська, 34,  
офіс 204-г  
03022, Київ  
Tel: (+380) 044 498 39 02  
info@gardena.ua

**Uruguay**

FELI SA  
Interno Ríos 1083 CP 11800  
Montevideo – Uruguay  
Tel: (+598) 22 03 18 44  
info@felisa.com.uy

**Venezuela**

Corporación Casa y Jardín C.A.  
Av. Caroní, Edif. Trezmen, PB.  
Colinas de Bello Monte,  
1050 Caracas.  
Tlf: (+58) 212 992 33 22  
info@casayjardin.net.ve

8875-20.960.04/0213  
© GARDENA  
Manufacturing GmbH  
D-89070 Ulm  
http://www.gardena.com