

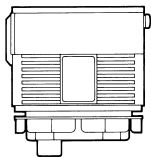

GARDENA®

lightline



Art. 4233

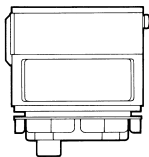

Art. 4235

- D Betriebsanleitung**
Dämmerungssensor, Bewegungsmelder
-
- GB Operating Instructions**
Dusk Sensor with Timer, Motion Detector
-
- F Mode d'emploi**
Contacteur crépusculaire programmable, Contacteur à détection de mouvement programmable
-
- NL Instructies voor gebruik**
Lichtgevoeligheidssensor, bewegingsmelder
-
- SCAN Bruksanvisning**
Skumringssensor, bevegelsessensor
-
- I Istruzioni per l'uso**
Crepuscolare, rilevatore di movimento
-
- E Manual de instrucciones**
Sensor crepuscular, detector de movimientos
-
- P Instruções de manejo**
Sensor de Crepúsculo, Aviso de movimentação

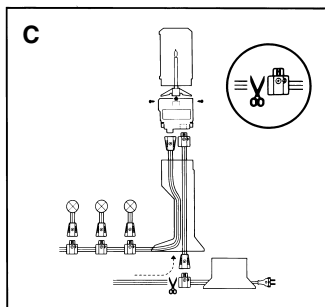
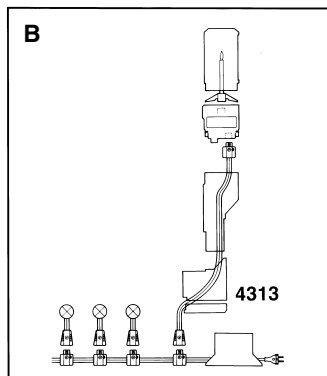
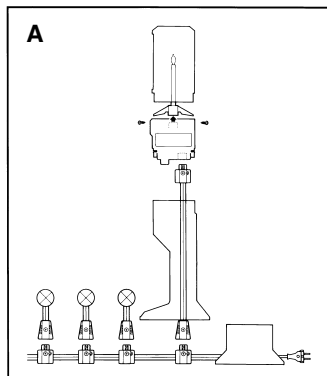
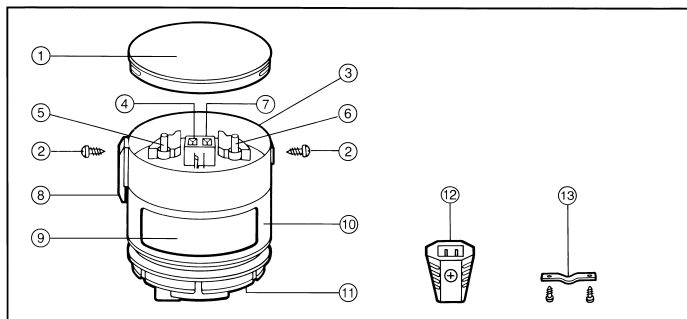

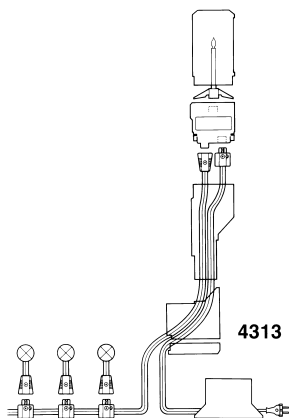
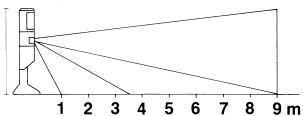
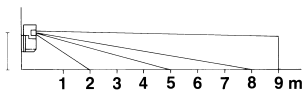
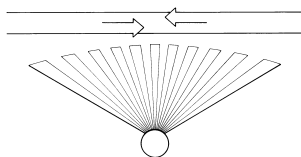
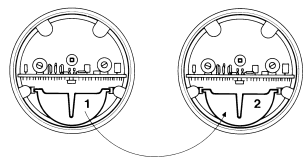
D**F₁** ≤ 1 m**F₂** > 1 m**E****G**

D**Inhalt**

Betriebsanleitung
Garantie

Seite

5 - 12
65

SCAN**Innhold**

Bruksanvisning
Garanti

Side

36 - 42
67

GB**Contents**

Operating Instructions
Guarantee

Page

13 - 20
65

I**Indice**

Istruzioni per l'uso
Garanzia

Pagina

43 - 49
67

F**Contenu**

Mode d'emploi
Garantie

Page

21 - 28
65

E**Índice**

Manual de instrucciones
Garantía

Página

50 - 57
68

NL**Inhoud**

Instructies voor gebruik
Garantie

Pagina

29 - 35
66

P**Conteúdo**

Instruções de manejo
Garantia

Página

58 - 64
68

GARDENA *lightline*

Dusk Sensor with Timer, Motion Detector



1. Information Concerning the Instructions

Translation of the original instructions from German.

Please read these instructions carefully before operating your system. Observe the notes included in the operating instructions. Use the operating instructions to get acquainted with the products, their proper use and the safety hints.

2. Applications

The GARDENA *lightline* system is a 12 Volt low-voltage system which makes your garden and your terrace come alive. You can choose, combine and install lamps according to your individual wishes and ideas. As the GARDENA *lightline* system is operated at 12 Volt low-voltage, it is safe and harmless.

3. Proper Use

The GARDENA *lightline* system has been manufactured for lighting gardens and terraces at low-voltage. Lamps must not be installed indoors.

Keeping to the operating instructions supplied by the manufacturer is absolutely required for proper use of the devices.

 **Attention! The GARDENA *lightline* controllers have been manufactured exclusively for 12 V low-voltage. Do not attempt to connect them to 220/230 volt, as this would prove very dangerous and cause fatal injury.**

4. Technical Data

	Dusk Sensor Art. 4233	Motion Detector Art. 4235
Voltage:	12 Volt low voltage	12 Volt low voltage
Switching current max.:	10 A AC	10 A AC
Breaking capacity max.:	100 W	100 W
Switch-on level:	3 - 100 Lux	3 - 80 Lux
Lighting duration:	40 min. - 8 hrs	1 - 30 min.
Operating temperature:	-20 °C - +50 °C	-20 °C - +50 °C
Range:		max. 9 m
Detection angle:		0 - 120°

5. Operating Parts

- ① Cover
- ② Screws for fixing the cover or the lamp shade
- ③ Receptacle for securing the lamp shade
- ④ Socket for lamp holder
- ⑤ Adjustment for time setting
- ⑥ Adjustment for brightness level
- ⑦ Screw for fixing the upper part of the casing
- ⑧ Solenoid switch for automatic or manual operation
- ⑨ Window (Art. No. 4233 only) or sensor foil with lens (Art. No. 4235 only)
- ⑩ Adjustment ring for lens of motion detector (Art. No. 4235 only)
- ⑪ Receptacle for socket of the lamp connection cable
- ⑫ Free plug for connecting to the installation cable when several lamps are controlled
- ⑬ Cable lock for fastening the installation cable at the lamp stand or at the lamp wall-holder (when several lamps are controlled)

6. Installation

The GARDENA *lightline* controllers can be used for controlling one individual or several lamps. Please consider the following hints.

6.1. Controlling an Individual Lamp

When the controllers are installed in the lamp, only the corresponding lamp is activated (ill. A). Those lamps connected behind the controller are not activated.



Avoid ring-like installation.



Install the controllers at a place where they are not fully exposed to the sun.

Installation in the Lamp (ill. A)

- Loosen the lamp shade by releasing both screws ②.
- Remove the lamp shade.
- Remove the lamp holder.
- Remove the socket from the lamp holder ④.
- Plug the socket into the receptacle of the controller ⑪.
- Remove the cover from the controller ①.
- Use the adjustments on the top of the controller to set the lighting duration and the brightness level (if applicable).
For details, see point 7 of these operating instructions.
- Plug the controller into the shade receptacle and fasten.
- Plug the lamp holder onto the controller.
- Put the lamp shade onto the controller and tighten both screws.

Within one installation cable you can control several individual lamps with several controllers. For this, you have to install in each lamp a controller as described above.

Installation in the Lamp Wall-holder, Art. No. 4313

For the lamps, a wall-holder is available (Art. No. 4313). In this wall-holder you can also integrate a controller (ill. B).

The lamp is supplied with approx. 2.5 feet of cable. If you mount the wall-holder at a higher place, use Art. No. 4302 extension cable.

The procedure is the same as for installation in the lamp. The controller is installed between shade receptacle and lamp shade (ill. B). The wall-holder can be mounted with 5 x 45 mm screws and 6 mm plugs on the wall.

6.2. Controlling Several Lamps via one Controller

 **If several lamps are to be activated by the controller, only one controller per cable loom and transformer exit may be used.**

When choosing this installation method, take care that the controller is always installed in the first lamp directly behind the transformer.

Only this way you can ensure that all lamps behind the controller (ill. C) are activated.

Installation in the first Lamp (ill. C)

- Remove the lamp shade and the lamp holder from the lamp as described under 6.1.
- Cut the cable as show in picture C.
- Loosen the shade receptacle from the lamp stand.
- Lead the cut installation cable through the lamp stand and the shade receptacle.
- Pull off the plug ⑫ from the controller.
- Loosen the cover of the plug and put the installation cable on the cutting contacts so that the end of the cable touches the thread bush of the screw.
- Press the cover firmly onto the bottom part of the plug and secure.
- Remove the lamp holder from the shade receptacle.
- Put the lamp connection cable into the receptacle on the controller ⑪.
- Put the plug ⑫ with the installation cable into the socket of the controller.
- Put the controller into the shade receptacle and secure.
- Remove the cover ① from the controller and put the lamp holder on to the controller so that the plug of the lamp holder fits the socket of the controller.
- Lighting duration and switch-on brightness level (if applicable) can be set via the adjustments. For more details see point 7 – Starting the Controllers.
- Put the lamp shade on to the controller and secure.
- Fasten the installation cable with the cable lock ⑬ at the cable outlet of the lamp stand.
- After having attached the installation cable to the controller you can connect further lamps to it. Consider the maximum connection capacity.

You can install the controller without the lamp in the lamp stand, if necessary. For this, put the cover ① on the controller.

Installation in the Lamp Wall-holder Art. No. 4313

You can integrate the controller also directly into the lamp wall-holder (ill. D).

- Loosen the cable lock at the lamp stand.
- Remove the shade receptacle with the cable and the lamp shade from the lamp stand.
- Remove the bottom part of the lamp wall-holder.
- Put the shade receptacle with the cable and the lamp shade onto the wall-holder.
- Cut the cable as show in picture C.
- Attach the plug with the controller to the free cable end as described above.
- Remove the lamp shade from the shade receptacle.
- Remove the lamp holder and loosen the connection cable from the lamp holder.
- Then put the connection cable into the receptacle on the controller.
- Lead the end of the installation cable with the plug through the wall-holder and the shade receptacle.
- Put the bottom part of the wall-holder onto the wall-holder and fasten both with the shade receptacle.
- Put the plug ⑫ on to the controller.
- Put the controller into the shade receptacle and fasten together.
- Fix the cable with the cable lock at the cable outlet of the lamp wall-holder.
- Put the lamp holder into the controller.
- Use the adjustments of the controller to set the lighting duration and the switch-on brightness (if applicable). See point 7 – Starting the Controllers.
- Then put the lamp shade onto the controller and secure it.
- See ill. D for connecting additional lamps to the installation cable. These lamps are to be activated by the pre-switched controller. Consider the maximum permitted connection taking care not to exceed capacity.

7. Starting the Controllers

All GARDENA *lightline* controllers (Art. No. 4233, 4235) are equipped with a solenoid switch ⑧. To de-activate the controllers push the switch (man.) downwards. This way you can switch your system to permanent lighting (if the transformer is connected to the power mains).



All GARDENA *lightline* controllers (Art. No. 4233, 4235) are activated automatically as soon as the transformer is connected to the power supply. The lights are activated until the set duration (1 - 30 min. for Motion Detector, 40 - 480 min. for Dusk Sensor) is terminated. This allows you to check whether the controllers have been properly installed.

Therefore, before operating the transformer, please check that the adjustment lever ⑤ has been set to min. (turn counterclockwise).



For starting the controllers, please remove the lamp shade and the cover of the controller.

Dusk Sensor

The Dusk Sensor switches your GARDENA *lightline* system automatically on and switches it off after termination of the lighting duration you have set. Install the Dusk Sensor in such a way that no external light is aimed at (street lamps, car head-lights) the window.

- Set the time adjustment to the desired lighting duration:
 min. = approx. 40 minutes (left end stop)  max. = approx. 8 hours (right end stop)



Intermediate position = approx. 4 hours.

- Use the adjustment  to set the desired brightness level:
 min. (left end stop) = darkness (3 Lux)  max. (right end stop) = dusk (100 Lux)

We recommend to set the adjustment for the brightness level  in Central Europe not higher than to an intermediate position.

Motion Detector

The Motion Detector switches your GARDENA *lightline* system on in the dark as soon as the infra-red sensor registers motion (thermal changes) in the detection area.

Via the adjustment ring  you can set the detection angle from 0° to 120°. For this loosen the screw .



We recommend you to install the Motion Detector crosswise to the moving direction (ill. E) to optimise the detection area.

The Motion Detector is equipped with a lens for two different detection areas. When supplied from the factory the lens is mounted for a detection area as shown in ill. F1 (figure 1 on the top of the lens holder).

We recommend this detection area when the Motion Detector is installed in the lamps up to a height of approx. 1 metre / 3 ft.

When installing the Motion Detector in the lamp wall-holder (Art. No. 4313) in a height of more than one metre we recommend you to turn the lens in the Motion Detector by 180° (ill. G).

For this, proceed as follows:

- Loosen the cover with both screws  from the Motion Detector.
- Then loosen the screw  from the top of the casing.
- Remove the lens holder from the guiding device, turn it by 180° and put back on its place (figure 2 on the top of the lens holder).



If the detection area is changed this way (ill. F2) motions below the detector are registered.



Adjust the window of the Motion Detector so that the desired detection area is covered.



Take care that the Motion Detector is not directed to water surfaces or other objects which are subject to heavy variation in temperature (e.g. trees, bushes, etc.).

Adjustment

- Set the time adjustment ⑤ to  min. (left end stop)
- Set the brightness adjustment ⑥ to  max. (right end stop)
- Enter the detection area. The motion detector switches the lamp(s) on.
- Correct the detection area, if necessary.
- Set the time adjustment ⑤ to the desired lighting duration: 1 - 30 min.
- Set the brightness adjustment ⑥ to the desired brightness level:

	min. (left end stop)		max. (right end stop)
= 3 Lux (darkness)		= 80 Lux (dusk)	

8. Trouble Shooting

Problem

Remedy

Individual lamps do not light up.

Defective lamps. Replace them with new 12 V, 10 W Halogen lamps.

Faulty switching of the Motion Detector.

Interfering objects like water, trees, etc. within the range of the Motion Detector. Adjust the detection angle within the ring so that these objects are not detected.

Motion detector responds too late.

Damp weather or fog reduce the range since damp air absorbs parts of the thermal radiation.

Faulty switching.

Extremely unfavourable weather conditions (snow, hail, storm) can cause faulty switching (switching on) of the Motion Detector.

External light (street-lamps etc.) can defect the operation of the Dusk Sensor. This is to be taken into consideration when adjusting the window of the Dusk Sensor.

Dusk Sensor does not switch on.

The daylight is below the set brightness level. Turn the adjustment for the brightness level ⑥ towards min. until light switches on.

Dusk Sensor does not switch off.

Permanent variations in brightness (clouds moving past). Turn the adjustment for the brightness level ⑥ towards min. until light switches off.

Should you have any further functional defects, please contact one of the GARDENA Service Centres or an authorised specialist.

We expressly point out that, in accordance with the product liability law, we are not liable for any damage caused by our units if it is due to improper repair or if parts exchanged are not original GARDENA parts or parts approved by us, and, if the repairs were not carried out by a GARDENA Service Centre or an authorised specialist. The same applies to spare parts and accessories.

9. Maintenance and Care

The GARDENA *lightline* controllers are maintenance-free.

The sensor foil of the Motion Detector can be cleaned from time to time with a moist rag (without using any detergents).

10. Safety and Operation Tips



Use the GARDENA *lightline* controllers and all other GARDENA *lightline* products exclusively for 12 volt low-voltage installations. Do not attempt to connect them to 220/230 volts – this would be very dangerous and may cause fatal injuries.



Take care that you do not touch lighted halogen lamps as they can inflict serious burns.



Before working on the GARDENA *lightline* installation, always disconnect the power plug of the transformer from the mains.

Disposal

(in accordance with RL2002/96/EC)



The product must not be added to normal household waste. It must be disposed of in line with local environmental regulations.

→ Important: Make sure that the unit is disposed of via your municipal recycling collection centre.

D

Garantie

GARDENA gewährt für diese Produkte 3 Jahre Garantie (ab Kaufdatum). Diese Garantieleistung bezieht sich auf alle wesentlichen Mängel, die nachweislich auf Material- oder Fabrikationsfehler zurückzuführen sind. Die Leuchtmittel (Lampen) sind von dieser Garantie-regelung ausgenommen. Wir weisen darauf hin, daß es bei den GARDENA *lightline* Artikeln aufgrund intensiver Sonneneinstrahlung zu farblichen Aufhellungen der Oberfläche kommen kann. Diese Veränderungen haben keine Auswirkung auf die Funktion und sind somit auch nicht Bestandteil unserer Garantieleistungen.

Die Garantieleistung erfolgt durch die Ersatzlieferung eines einwandfreien Gerätes oder durch die kostenlose Reparatur des eingesandten Gerätes nach unserer Wahl, wenn folgende Voraussetzungen gewährleistet sind:

- Das Gerät wurde sachgemäß und laut den Empfehlungen in der Betriebsanleitung behandelt.
- Es wurde weder vom Käufer noch von einem Dritten versucht, das Gerät zu reparieren.

Diese Hersteller-Garantie berührt die gegenüber dem Händler/ Verkäufer bestehenden Gewährleistungsansprüche nicht. Im Garantiefall schicken Sie bitte das defekte Gerät zusammen mit einer Kopie des Kaufbelegs und einer Fehlerbeschreibung per Abhol-Service (nur in Deutschland) oder frankiert an die auf der Rückseite angegebene Serviceadresse.

Unfreie Paketeinsendungen werden im Post-verteilstützpunkt ausgefiltert und erreichen uns nicht.

Nach folgender Reparatur senden wir das Gerät frei an Sie zurück.

GB

Guarantee

GARDENA guarantees these products for 3 years (from date of purchase).

This guarantee covers all serious defects of the unit that can be proved to be material or manufacturing faults. We would like to point out that the GARDENA *lightline* products may fade if exposed to intense sunlight. This in no way affects the function of the products and is, therefore, not part of the standard warranty.

Under warranty we will either replace the unit or repair it free of charge if the following conditions apply:

- The unit must have been handled properly and in keeping with the requirements of the operating instructions.
Neither the purchaser nor a non-authorised third party have attempted to repair the unit.
- The unit has been returned directly to a GARDENA Service Centre, postage paid, together with the completed and signed warranty card and proof of purchase.

This manufacturer's guarantee does not affect the user's existing warranty claims against the dealer/ seller.

In case of claim cut out the warranty card and send it together with the unit to the GARDENA Service Centre.

F

Garantie

Pour mieux vous servir, GARDENA accorde pour cet appareil une garantie contractuelle de 3 ans à compter du jour de l'achat. Elle est assurée par le remplacement gratuit des pièces défectueuses ou de l'appareil.

EU-Konformitätserklärung

D

Der Unterzeichnete,

GARDENA Manufacturing GmbH, Hans-Lorenser-Str. 40, D-89079 Ulm,

bestätigt, daß die nachfolgend bezeichneten Geräte in der von uns in Verkehr gebrachten Ausführung die Anforderungen der harmonisierten EU-Richtlinien, EU-Sicherheitsstandards und produktspezifischen Standards erfüllen.

Bei einer nicht mit uns abgestimmten Änderung der Geräte verliert diese Erklärung ihre Gültigkeit.

Bezeichnung der Geräte:
lightline Dämmerungssensor
lightline Bewegungsmelder

Art.-Nr.: 4233 / 4235

EU-Richtlinien:
Elektromagn. Verträglichkeit
2004/108/EG
Richtlinie 93/68/EG

Ulm, den 11.08.1998



Thomas Heintl
Technische Leitung

EU Certificate of Conformity

GB

The undersigned

GARDENA Manufacturing GmbH · Hans-Lorenser-Str. 40 · D-89079 Ulm

hereby certifies that, when leaving our factory, the units indicated below are in accordance with the harmonised EU guidelines, EU standards of safety and product specific standards.

This certificate becomes void if the units are modified without our approval.

Description of the units:
lightline Dusk Sensor with Timer
lightline Motion Detector

Art. no.: 4233 / 4235

EU directives:
Electromagnetic Compatibility
2004/108/EC
Directive 93/68/EC

Ulm, 11.08.1998



Thomas Heintl
Technical Dept. Manager

Deutschland / Germany

GARDENA
Manufacturing GmbH
Central Service
Hans-Lorenser-Straße 40
D-89079 Ulm
Produktfragen:
(+49) 731 490-123
Reparaturen:
(+49) 731 490-290
service@gardena.com

Argentina

Husqvarna Argentina S.A.
Vera 745
(C1414A00) Buenos Aires
Phone: (+54) 11 4858-5000
diego.poggi@
ar.husqvarna.com

Australia

Husqvarna Australia Pty. Ltd.
Locked Bag 5
Central Coast BC
NSW 2250
Phone: (+61) 1800 802831
customer.service@
husqvarna.com.au

Austria / Österreich

Husqvarna Austria GmbH
Consumer Products
Industriezeile 36
4010 Linz
Tel.: (+43) 732 77 01 01 - 90
consumer.service@
husqvarna.at

Belgium

GARDENA Belgium NV/SA
Sterrebeekstraat 163
1930 Zaventem
Phone: (+32) 2 720 92 12
Mail: info@gardena.be

Brazil

Palash Comércio e
Importação Ltda.
Rua São João do Araguaia,
338 – Jardim Califórnia –
Barueri – SP - Brasil –
CEP 06409-060
Phone: (+55) 11 4198-9777
eduardo@palash.com.br

Bulgaria

Хускварна България ЕООД
1799 София
Бул. „Андрей Ляпчев“ № 72
Тел.: (+359) 2 80 99 424
www.husqvarna.bg

Canada

GARDENA Canada Ltd.
100 Summerlea Road
Brampton, Ontario L6T 4X3
Phone: (+1) 905 792 93 30
info@gardenacanada.com

Chile

Antonio Martinic y Cia Ltda.
Cassillas 272
Centro de Cassillas
Santiago de Chile
Phone: (+56) 2 20 10 708
garfar_cl@yahoo.com

Costa Rica

Compania Exim
Euroiberoamericana S.A.
Los Colegios, Moravia,
200 metros al Sur del Colegio
Saint Francis - San José
Phone: (+506) 297 68 83
exim_euro@racsa.co.cr

Croatia

KLIS d.o.o.
Stancecva 79
10419 Vukovina
Phone: (+385) 1 622 777 0
gardena@klis-trgovina.hr

Cyprus

FARMOKIPIKI LTD
P.O. Box 7098
74, Digeni Akrita Ave.
1641 Nicosia
Phone: (+357) 22 75 47 62
condam@spidernet.com.cy

Czech Republic

GARDENA spol. s r.o.
Tuřanka 115
627 00 Brno
Phone: (+420) 548 217 777
gardena@gardenabrno.cz

Denmark

GARDENA
Husqvarna Consumer
Outdoor Products
Salgsafdelning Danmark
Box 9003
S-200 39 Malmö
info@gardena.dk

Estonia

Husqvarna Eesti OÜ
Consumer Outdoor Products
Kesk tee 10, Aaviku küla
Rae vald, Harju maakond
75305
kontakt.etj@husqvarna.ee

Finland

Oy Husqvarna Ab
Consumer Outdoor Products
Lautatarhankatu 8 B/ PL 3
00581 HELSINKI
info@gardena.fi

France

GARDENA France
Immeuble Exposial
9 - 11 allée des Pierres
Mayettes
ZAC des Barbanniers
B.P. 99
-F- 92232 GENNEVILLIERS
cedex
Tél. (+33) 01 40 85 30 40
service.consommateurs@
gardena.fr

Great Britain

Husqvarna UK Ltd
Preston Road
Aycliffe Industrial Park
Newton Aycliffe
County Durham
DL5 6UP
info.gardena@
husqvarna.co.uk

Greece

HUSQVARNA GREECE S.A.
Branch of Koropi
Ifestou 33A
Industrial Area Koropi
194 00 Athens – Greece
V.A.T. EL094094640
Phone: (+30) 210 66 20 225
info@husqvarna-consumer.gr

Hungary

Husqvarna
Magyarország Kft.
Ezred u. 1 - 3
1044 Budapest
Phone: (+36) 80 20 40 33
gardena@gardena.hu

Iceland

O. Johnson & Kaaber
Tunguhalsi 1
110 Reykjavik
ooj@ojk.is

Ireland

Michael McLoughlin & Sons
Hardware Limited
Long Mile Road
Dublin 12

Italy

GARDENA Italia S.p.A.
Via Donizetti 22
20020 Lainate (Mi)
Phone: (+39) 02.93.94.79.1
info@gardenaitalia.it

Japan

KAKUICHI Co. Ltd.
Sumitomo Realty &
Development Kojimachi
BLDG., 8F,
5-1 Nibanncho, Chiyoda-ku
Tokyo 102-0084
Phone: (+81) 33 264 4721
m_ishihara@kaku-ichi.co.jp

Latvia

SIA „Husqvarna Latvija”
Consumer Outdoor Products
Bākūžu iela 6
Rīga, LV-1024
info@husqvarna.lv

Lithuania

UAB Husqvarna Lietuva
Consumer Outdoor Products
Ateities pl. 77C
LT-52104 Kaunas
centras@husqvarna.lt

Luxembourg

Magasins Jules Neuberg
39, rue Jacques Stas
Luxembourg-Gasperich
2549
Case Postale No. 12
Luxembourg 2010
Phone: (+352) 40 14 01
api@neuberg.lu

Netherlands

GARDENA Nederland B.V.
Postbus 50176
1305 AD ALMERE
Phone: (+31) 36 521 00 00
info@gardena.nl

Neth. Antilles

Jonka Enterprises N.V.
Sta. Rosa Weg 196
P.O. Box 8200, Curaçao
Phone: (+599) 9 767 66 55
pgm@jonka.com

New Zealand

Husqvarna
New Zealand Ltd.
PO Box 76437
Manukau City 2241
Phone: (+64) 09 9202410

Norway

GARDENA
Husqvarna Consumer
Outdoor
Products
Salgskontor Norge
Kleverteien 6
1540 Vestby
info@gardena.no

Poland

Husqvarna
Poland Spółka z o.o.
Oddział w Szymanowie
Szymanów 9 d
05-532 Baniocza
Phone: (+48) 22 727 56 90
gardena@gardena.pl

Portugal

GARDENA Portugal Lda.
Sintra Business Park
Edifício 1
Fracção 0-G
2710-089 Sintra
Phone: (+351) 21 922 85 30
info@gardena.pt

Romania

MADEX
INTERNATIONAL SRL
Soseaua Odaii 117-123,
Sector 1,
București, RO 013603
Phone: (+40) 21 352 76 03
madex@ines.ro

Russia

ООО ГАРДЕНА РУС
123007, г. Москва
Хорошевское шоссе,
д. 32А
Тел.: (+7) 495 380 31 92
info@gardena-rus.ru

Singapore

Hy-Ray PRIVATE LIMITED
40 Jalan Pemimpin
#02-08 Tat Ann Building
Singapore 577185
Phone: (+65) 6253 2277
shiyang@hyray.com.sg

Slovak Republic

GARDENA spol. s r.o.
Tuřanka 115
627 00 Brno
Phone: (+420) 548 217 777
gardena@gardenabrno.cz

Slovenia

GARDENA d.o.o.
Brodišče 15
1236 Trzin
Phone: (+386) 1 580 93 32
servis@gardena.si

South Africa

GARDENA
South Africa (Pty.) Ltd.
P.O. Box 11534
Vorna Valley 1686
Phone: (+27) 11 315 02 23
sales@gardena.co.za

Spain

GARDENA IBÉRICA S.L.U.
C/ Basauri, nº 6
La Florida
28023 Madrid
Phone: (+34) 91 708 05 00
atencioncliente@gardena.es

Sweden

GARDENA
Husqvarna Consumer
Outdoor Products
Försäljningskontor Sverige
Box 9003
200 39 Malmö
info@gardena.se

Switzerland / Schweiz

Husqvarna Schweiz AG
Consumer Products
Industriestrasse 10
5506 Mägenwil
Phone: (+41) (0) 848 800 464
info@gardena.ch

Turkey

GARDENA / Dost Diş Ticaret
Müessesilik A.Ş. Sanayi
Çad. Adil Sokak No. 1
Kartal - İstanbul
Phone: (+90) 216 38 93 939
info@gardena-dost.com.tr

Ukraine / Україна

ТОВ «ГАРДЕНА УКРАЇНА»
Васильківська, 34, 204-Г
03022, Київ
Тел. (+38 044) 498 39 02
info@gardena.ua

4233-29.960.03/0508
© GARDENA
Manufacturing GmbH
D-89070 Ulm
http://www.gardena.com