

3 l
Art. 867

5 l
Art. 869

5 l
Art. 875

5 l
Art. 879 / 880

D Betriebsanleitung
Drucksprüher

GB Operating Instructions
Pressure Sprayer

F Mode d'emploi
Pulvérisateur à pression préalable / Pulvérisateur

NL Instructies voor gebruik
Drukspuit

S Bruksanvisning
Tryckspruta

I Istruzioni per l'uso
Irroratore a pressione

E Manual de instrucciones
Pulverizador a presión

P Instruções de utilização
Pulverizador de Pressão

DK Brugsanvisning
Trykspøjtje

GARDENA Pressure Sprayer

Welcome to the garden of GARDENA...



Translation of the original instructions from German. Please read these operating instructions carefully and observe the notes given. Use these operating instructions to familiarise yourself with the Pressure Sprayer, its proper use and the notes on safety.



For safety reasons, children and young people under 16 as well as anyone not familiar with these operating instructions should not use the Pressure Sprayer.

→ Please keep these operating instructions in a safe place.

Contents

1. Where to Use Your GARDENA Pressure Sprayer	10
2. Safety Instructions	11
3. Assembly	12
4. Operation	13
5. Cleaning	15
6. Trouble-Shooting	15
7. Storage	16
8. Accessories	16
9. Technical data	16
10. Service	16

1. Where to Use Your GARDENA Pressure Sprayer

Intended purpose

The GARDENA Pressure Sprayer is intended for distributing solvent-free liquid pesticides¹⁾, herbicides¹⁾, fertilisers¹⁾, window cleaners¹⁾, and car wax¹⁾ in domestic gardens and allotments.

It must not be used in public places, parks, sport arenas, or in agriculture or forestry.

Compliance with the operating instructions provided by the manufacturer is a prerequisite for using the Pressure Sprayer correctly.

1) In accordance with the laws governing the use of pesticides and detergents, only authorised substances may be used (authorised specialist shop).

Caution!



Due to the risk of physical injury, the GARDENA Pressure Sprayer must not be used for spraying substances other than those specified by GARDENA. Do not use your Pressure Sprayer for spraying acids, disinfectants or water-proofing agents.

We recommend that you only use pesticides approved by the BBA (German Federal Biological Research Centre for Agriculture and Forestry). To our knowledge at the time of manufacturing the unit, the pesticides approved by the BBA will not damage the materials used to construct the Pressure Sprayer.

When spraying insecticides, herbicides and fungicides or other liquid plant protection products, you must comply with all special precautionary measures specified by the manufacturer of the product you are using.

2. Safety Instructions

Danger of physical injuries:



- Never open the Pressure Sprayer or unscrew the nozzle when the Pressure Sprayer is still pressurised.
- To prevent injury, never connect the Pressure Sprayer to an air-compressor.
- Before pulling out the safety valve, the sprayer always has to be placed vertically.
- Before opening the sprayer, always release pressure completely by pulling out the safety valve.
Attention: A liquid-air mixture can escape.

Cleaning:



- Release the pressure after each use (ensuring that the Pressure Sprayer is always vertical), empty the container, clean it carefully and rinse with clear water. Then leave the pressure sprayer open and allow it to dry.

Do not dispose of residual fluids in the sewerage system (→ local disposal systems).

- Always clean the Pressure Sprayer before using a different product to avoid chemical reactions.

For cleaning the valves, the spray pipe and nozzle, operate the unit with clear water (if necessary, by adding some washing-up liquid).

- To prevent reactions with the products you are using, never use aggressive cleaning agents that contain solvent or petrol.
- When there is dirt on the container cap or the container, clean the container carefully around the thread and the thread O-ring.

Take care not to mix up the tanks and tank caps if you are using several Pressure Sprayers at the same time.

Operation:

- Inspect the Pressure Sprayer visually before each use. Never leave your Pressure Sprayer unattended or for long periods when full and pressurised.

- Keep the unit out of the reach of children.

You are responsible for the safety of others.

- Operate the safety valve only when the sprayer is placed vertically.

- Keep your Pressure Sprayer away from heat sources and hot environments.

We recommend that you have your Pressure Sprayer thoroughly inspected (preferably at a GARDENA Service Centre) after using it for 5 years.

Storage:

Before storing, loosen the tank cap and always empty your Pressure Sprayer completely (also after cleaning with water). Store away from frost.

- If you use the permanent lock pay attention that you work very carefully. Never store your pressure sprayer with permanent lock.

3. Assembly

3.1. General Assembly Instructions for all Pressure Sprayers (Art. No. 867/869/875/879/880)

Mounting the spray tube in the hand valve:

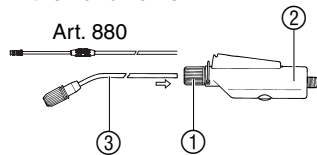

1. Unscrew the union nut ① on the hand valve ②.
2. Push the spray tube ③ all the way into the hand valve ②.
3. Tighten the union nut ① on the hand valve ② by hand (do not use pliers).

The sprayer tube of art. 880 is telescopic (min. / max. sprayer tube length 60 / 100 mm).

Attaching the spray hose to the hand valve:

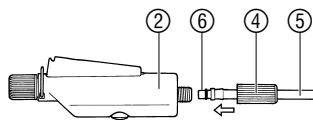

1. Push the long union nut ④ over the spray hose ⑤.
2. Push the spray hose ⑤ with connection nipple ⑥ into the hand valve ②.
3. Tighten the long union nut ④ on the hand valve ② by hand (do not use pliers).

3.2. Assembly Instructions for Pressure Sprayer Art. No. 869

Installing the filter and suction pipe:

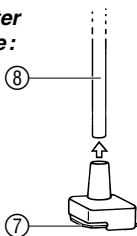

1. Shut the filter ⑦ and press firmly into the suction pipe ⑧.
2. Guide the suction pipe ⑧ through the eyelet at the pump tube ⑨ and press firmly into the opening in the container cap.

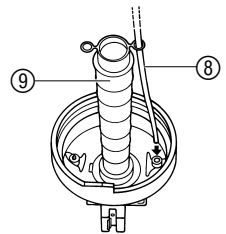

Attaching the spray hose to the container cap:

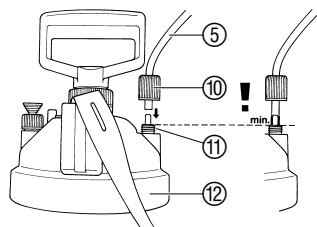

1. Push the short union nut ⑩ over the spray hose ⑤.
2. Push on the spray hose ⑤ so that it covers at least the beginning of the thread ⑪.
3. Screw the short union nut ⑩ onto the container cap ⑫ and tighten by hand (do not use pliers).

Attaching the shoulder strap:

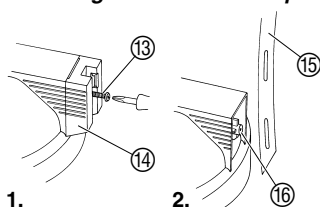

1. Unscrew the screw ⑬ using a screwdriver and remove the spray tube holder ⑭.
2. Put the shoulder strap ⑮ with the elongated hole over the plastic tube ⑯.
3. Reattach the spray tube holder ⑭ and screw in the screw ⑬ using a screwdriver.

3.3. Assembly Instructions for Pressure Sprayer Art. No. 875 / 879 / 880

Attaching the spray hose to the container cap:

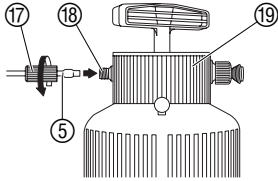

1. Push the short union nut ⑰ over the spray hose ⑤.
2. Push on the spray hose ⑤ so that it covers at least the beginning of the thread ⑱.
3. Screw the short union nut ⑰ onto the container cap ⑲ and tighten by hand (do not use pliers).

Attaching the shoulder strap:

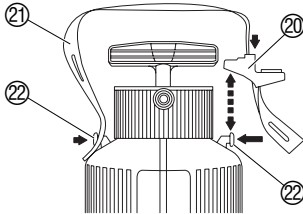

1. Remove the spray tube holder ⑳ from above (direction of the arrow).
2. Guide the shoulder strap ㉑ through the elongated hole of the spray tube holder ⑳ and attach it into the holder ㉒ of the container.
3. Press the spray tube holder back on until you hear it click into place.
4. Attach the shoulder strap on the other side of the holder ㉒.

4. Operation

4.1. Operating Instructions for Pressure Sprayer Art. No. 867 / 869

Filling the container:

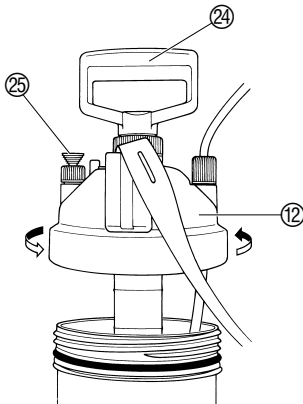

1. Mix the fluid well.
2. Unscrew the container cap ⑫.
3. Pour the fluid into the container up to the maximum mark (3 litres or 5 litres).
Please observe the safety and proportioning instructions provided by the manufacturer of the product you are going to spray.
4. Screw the container cap ⑫ back on and tighten by hand (do not use pliers).



Risk of injury!

→ **Never connect your Pressure Sprayer to an air compressor.**

5. Pull the pump lever ㉔ repeatedly (approx. 30 to 40 times) until the operating pressure has been reached.
Any excess pressure escapes through the safety valve ㉕.

4.2. Operating Instructions for Pressure Sprayer Art. No. 875/879/880

Filling the container:

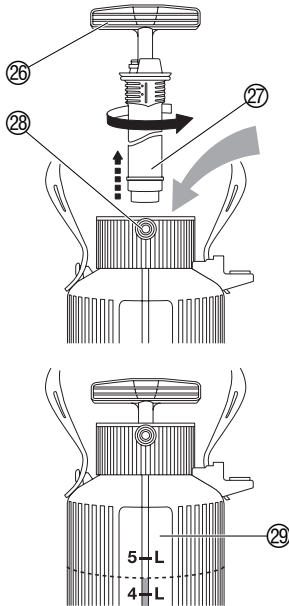

1. Mix the fluid well.
2. Press the pump handle ②⑥ down slightly, turn to the left and remove the pump ②⑦.
3. Pour the fluid into the container up to the maximum mark (5 litres).
Please observe the safety and proportioning instructions provided by the manufacturer of the product you are going to spray.
4. Tighten the pump again with the pump handle ②⑥ by hand (do not use pliers).



Risk of injury!

→ **Never connect your Pressure Sprayer to an air compressor.**

5. Unlock the pump handle ②⑥ by turning slightly to the left and pump the pump repeatedly (approx. 30 - 40 times) until the operating pressure is reached.
Any excess pressure escapes through the safety valve ②⑧.

The Pressure Sprayer Art. No. 879/880 features a window with a scale ②⑨ to help you measure out the appropriate dosage of fertilisers. The window also allows you to see how much fluid is left in the container.

4.3. General Operating Instructions for all Pressure Sprayers

Spraying:

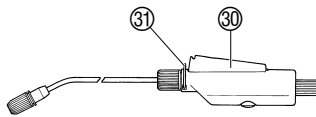

1. Press the operating switch ③⑩ on the handle.
The Pressure Sprayer begins spraying.
 2. Release the operating switch ③⑩ on the handle.
The Pressure Sprayer stops spraying.
- Setting the permanent lock:
→ Press the permanent lock ③①.
The operating switch ③⑩ is pressed down and stays down.

Adjusting the spray tube:

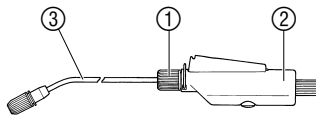

The spray tube can be swivelled 360° in the hand valve.

1. Unscrew the union nut ① on the hand valve ②.
2. Turn the spray tube ③ to the correct position.
3. Tighten the union nut ① on the hand valve ② by hand (do not use pliers).

Setting the spray jet:

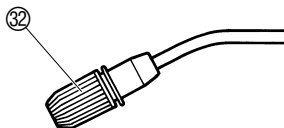

You can adjust the spray jet from full jet (nozzle closed) to a fine mist spray (nozzle open).

→ Open or close the spray nozzle ③② according to the spray jet you require.

Fertilisation with GARDENA Universal Liquid Fertiliser Art. 8303 for outdoor use:

For sheet fertilisation and young plants:
1/2 cover cap on approx. 5 l spraying liquid

For root fertilisation:
1 cover cap on approx. 5 l spraying liquid

5. Cleaning

Cleaning the Pressure Sprayer:

Always clean your Pressure Sprayer after spraying.

→ Fill the Pressure Sprayer with clean water (the water may contain some washing-up liquid if necessary) and empty out the water by spraying it through the spray tube in the same way as when spraying a product.

This cleans the valves, the spray tube and the nozzles.

We recommend that you have your Pressure Sprayer thoroughly inspected (preferably at a GARDENA Service Centre) after using it for 5 years.

6. Trouble-Shooting

Cleaning the filter:

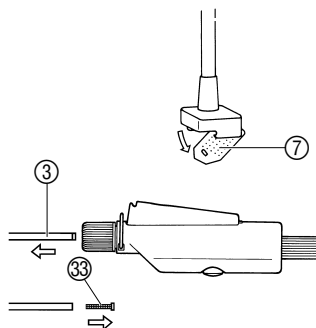

If the spray jet from the Pressure Sprayer is very weak you should clean the filter in the container.

Pressure Sprayer Art. No. 867/869

1. Unscrew the container cap.
2. Flip up the filter ⑦ and rinse under running water.
3. Close the filter ⑦ and screw the container cap back on.

Pressure Sprayer Art. No. 875/879/880

Remove the filter ③③ from the spray tube ③ and clean it.

Problem	Possible Cause	Remedy
Pump does not build up pressure.	Container cap is not airtight.	→ Fasten the container cap as tight as it will go (Art. 867/869).
	Safety valve is loose.	→ Tighten the safety valve.
	Hose connection at the container and hand valve is not tight.	→ Tighten the hose connections at the container and hand valve.
	Continuous lock enabled on handle.	→ Take off the permanent lock at the hand valve.
Pressure Sprayer does not spray although there is sufficient pressure or only sprays with a weak spray jet.	Nozzle is blocked.	→ Clean the nozzle.
	Filter is blocked.	→ Clean the filter in the container (Art. 867/869). Clean the filter in the spray tube (Art. 875/879/880).
It is difficult to open and close the container.	Container pressure too high.	→ Release the container pressure completely by means of the safety valve. Grease the container O-ring with acid-free grease (Art. 867/869).

If you have any other problems with your Pressure Sprayer please contact GARDENA Customer Service.

7. Storage

Storing your Pressure Sprayer:

1. Clean the Pressure Sprayer (refer to 5. Cleaning).
2. Keep your Pressure Sprayer in a place protected from frost.

8. Accessories

GARDENA Weedkiller Cone	Prevents spray mist from blowing away.	Art. No. 894
GARDENA Extension Lance	For extending the spray tube.	Art. No. 897
GARDENA Telescopic Tube	Telescopic extension for the spray tube.	Art. No. 899

9. Technical data

	Art. No. 867	Art. No. 869 / 875 / 879	Art. No. 880
Max. capacity	3 l (5 pints approx.)	5 l (8 pints approx.)	5 l (8 pints approx.)
Spray tube length	36 cm	36 cm	60/100 cm
Hose length	150 cm	150 cm	150 cm
Permissible working pressure	3 bar	3 bar	3 bar
Permissible operating temperature	40 °C	40 °C	40 °C

10. Service

Warranty

GARDENA guarantees this product for 2 years (from date of purchase). This guarantee covers all serious defects of the unit that can be proved to be material or manufacturing faults. Under warranty we will either replace the unit or repair it free of charge if the following conditions apply:

- The unit must have been handled properly and in keeping with the requirements of the operating instructions.
- Neither the purchaser or a non-authorised third party have attempted to repair the unit.

This manufacturer's guarantee does not affect the user's existing warranty claims against the dealer/seller.

If you have any problems with your Pressure Sprayer, please contact our Customer Service or return the defective unit together with a short description of the problem directly to one of the GARDENA Service Centres listed on the back of this leaflet.

Product Liability

We expressly point out that, in accordance with the product liability law, we are not liable for any damage caused by our units if it is due to improper repair or if parts exchanged are not original GARDENA parts or parts approved by us, and, if the repairs were not carried out by a GARDENA Service Centre or an authorised specialist. The same applies to spare parts and accessories.

Deutschland / Germany

GARDENA
Manufacturing GmbH
Central Service
Hans-Lorenser-Straße 40
D-89079 Ulm
Produktfragen:
(+49) 731 490-123
Reparaturen:
(+49) 731 490-290
service@gardena.com

Argentina

Husqvarna Argentina S.A.
Vera 745
(C1414AOO) Buenos Aires
Phone: (+54) 11 4858-5000
diego.poggi@ar.husqvarna.com

Australia

Husqvarna Australia Pty. Ltd.
Locked Bag 18
Gosford NSW 2250
Phone: (+61) (0) 2 4372 1500
customer.service@
husqvarna.com.au

Austria / Österreich

Husqvarna Austria GmbH
Consumer Products
Industriezeile 36
4010 Linz
Tel.: (+43) 732 77 01 01 - 90
consumer.service@
husqvarna.at

Belgium

GARDENA Belgium NV/SA
Sterrebeekstraat 163
1930 Zaventem
Phone: (+32) 2 72092 12
Mail: info@gardena.be

Brazil

Palash Comércio e
Importação Ltda.
Rua São João do Araguaia, 338
- Jardim Califórnia -
Barueri - SP - Brasil -
CEP 06409-060
Phone: (+55) 11 4198-9777
eduardo@palash.com.br

Bulgaria

Хускварна България ЕООД
1799 София
Бул. „Андрей Ляпчев“ № 72
Тел.: (+359) 2 80 99 424
www.husqvarna.bg

Canada

GARDENA Canada Ltd.
100 Summerlea Road
Brampton, Ontario L6T 4X3
Phone: (+1) 905 792 9330
info@gardenacanada.com

Chile

Antonio Martinic y Cia Ltda.
Cassillas 272
Centro de Cassillas
Santiago de Chile
Phone: (+56) 2 20 10 708
garfar_cl@yahoo.com

Costa Rica

Compania Exim
Euroberoamericana S.A.
Los Colegios, Moravia,
200 metros al Sur del Colegio
Saint Francis - San José
Phone: (+506) 297 68 83
exim_euro@racsa.co.cr

Croatia

KLIS d.o.o.
Stanciceva 79
10419 Vukovina
Phone: (+385) 1 622 777 0
gardena@klis-trgovina.hr

Cyprus

FARMOKIPIKI LTD
P.O. Box 7098
74, Digeni Akritas Ave.
1641 Nicosia
Phone: (+357) 22 75 47 62
condam@spidernet.com.cy

Czech Republic

GARDENA spol. s r.o.
Tuřanka 115
627 00 Brno
Phone: (+420) 548 217 777
gardena@gardenabrn.cz

Denmark

GARDENA
Husqvarna Consumer Outdoor
Products
Salgsafdelning Danmark
Box 9003
S-200 39 Malmö
info@gardena.dk

Estonia

Husqvarna Eesti OÜ
Consumer Outdoor Products
Kesk tee 10, Aaviku küla
Rae vald, Harju maakond
75305
kontakt.etj@husqvarna.ee

Finland

Oy Husqvarna Ab
Consumer Outdoor Products
Lautatarhankatu 8 B / PL 3
00581 HELSINKI
info@gardena.fi

France

GARDENA France
Immeuble Exposial
9 - 11 allée des Pierres Mayettes
ZAC des Barbanniers, B.P. 99
- F - 92232 GENNEVILLIERS
cedex
Tél. (+33) 01 40 85 30 40
service.consommateurs@
gardena.fr

Great Britain

Husqvarna UK Ltd
Preston Road
Aycliffe Industrial Park
Newton Aycliffe
County Durham
DL5 6UP
info.gardena@
husqvarna.co.uk

Greece

HUSQVARNA GREECE S.A.
Branch of Koropi
Ifestou 33A
Industrial Area Koropi
194 00 Athens - Greece
V.A.T. EL094094640
Phone: (+30) 210 66 20 225
info@husqvarna-consumer.gr

Hungary

Husqvarna
Magyarország Kft.
Ezred u. 1 - 3
1044 Budapest
Phone: (+36) 80 20 40 33
gardena@gardena.hu

Iceland

Ó. Johnson & Kaaber
Tunguhalsi 1
110 Reykjavik
ooj@ojk.is

Ireland

Michael McLoughlin & Sons
Hardware Limited
Long Mile Road
Dublin 12

Italy

GARDENA Italia S.p.A.
Via Donizetti 22
20020 Lainate (Mi)
Phone: (+39) 02.93.94.79.1
info@gardenaitalia.it

Japan

KAKUICHI Co. Ltd.
Sumitomo Realty &
Development Kojimachi
BLDG., 8F, 5-1 Nibanbany,
Chiyoda-ku, Tokyo 102-0084
Phone: (+81) 33 264 4721
m_ishihara@kaku-ichi.co.jp

Latvia

SIA „Husqvarna Latvija“
Consumer Outdoor Products
Bakūžu iela 6, Rīga, LV-1024
info@husqvarna.lv

Lithuania

UAB Husqvarna Lietuva
Consumer Outdoor Products
Atleities pl. 77C
LT-52104 Kaunas
centras@husqvarna.lt

Luxembourg

Magasins Jules Neuberg
39, rue Jacques Stas
Luxembourg-Gasperich 2549
Case Postale No. 12
Luxembourg 2010
Phone: (+352) 40 14 01
api@neuberg.lu

Netherlands

GARDENA Nederland B.V.
Postbus 50176
1305 AD ALMERE
Phone: (+31) 36 521 00 00
info@gardena.nl

Neth. Antilles

Jonka Enterprises N.V.
Sta. Rosa Weg 196
P.O. Box 8200, Curaçao
Phone: (+599) 9 767 66 55
pgm@jonka.com

New Zealand

Husqvarna New Zealand Ltd.
PO Box 76437
Manukau City 2241
Phone: (+64) (09) 92024 10

Norway

GARDENA
Husqvarna Consumer Outdoor
Products
Salgskontor Norge
Kleiverveien 6
1540 Vestby
info@gardena.no

Poland

Husqvarna Poland Spółka z o.o.
Oddział w Szymanowie
Szymanów 9 d
05-532 Baniocha
Phone: (+48) 22 727 56 90
gardena@gardena.pl

Portugal

GARDENA Portugal Lda.
Sintra Business Park
Edifício 1, Fracção 0-G
2710-089 Sintra
Phone: (+351) 21 922 85 30
info@gardena.pt

Romania

MADEX INTERNATIONAL SRL
Soseaua Odaii 117-123,
Sector 1,
București, RO 013603
Phone: (+40) 21 352 76 03
madex@ines.ro

Russia

ООО ГАРДЕНА PVC
123007, г. Москва
Хорошевское шоссе, д. 32А
Тел.: (+7) 495 380 31 92
info@gardena-rus.ru

Singapore

Hy - Ray PRIVATE LIMITED
40 Jalan Pemimpin
#02-08 Tat Ann Building
Singapore 577185
Phone: (+65) 6253 2277
shiyang@hyray.com.sg

Slovak Republic

GARDENA spol. s r.o.
Tuřanka 115
627 00 Brno
Phone: (+420) 548 217 777
gardena@gardenabrn.cz

Slovenia

GARDENA d.o.o.
Brodšče 15
1236 Trzin
Phone: (+386) 1 580 93 32
servis@gardena.si

South Africa

GARDENA
South Africa (Pty.) Ltd.
P.O. Box 11534
Vorna Valley 1686
Phone: (+27) 11 315 02 23
sales@gardena.co.za

Spain

GARDENA IBÉRICA S.L.U.
C/ Basauri, nº 6
La Florida
28023 Madrid
Phone: (+34) 91 708 05 00
atencioncliente@gardena.es

Sweden

GARDENA
Husqvarna Consumer Outdoor
Products
Försäljningskontor Sverige
Box 9003
200 39 Malmö
info@gardena.se

Switzerland / Schweiz

Husqvarna Schweiz AG
Consumer Products
Industriestrasse 10
5506 Mägenwil
Phone: (+41) (0) 848 800 464
info@gardena.ch

Turkey

GARDENA / Dost Diş Ticaret
Müessesilik A.Ş. Sanayi
Çad. Adil Sokak No. 1
Kartal - Istanbul
Phone: (+90) 216 38 93 939
info@gardena-dost.com.tr

Ukraine / Україна

ТОВ «ГАРДЕНА УКРАЇНА»
Васильківська, 34, 204-Г
03022, Київ
Тел. (+38 044) 498 39 02
info@gardena.ua

879-20.960.08/0608

© GARDENA
Manufacturing GmbH
D-89070 Ulm
http://www.gardena.com