

GARDENA® Micro-Drip-System

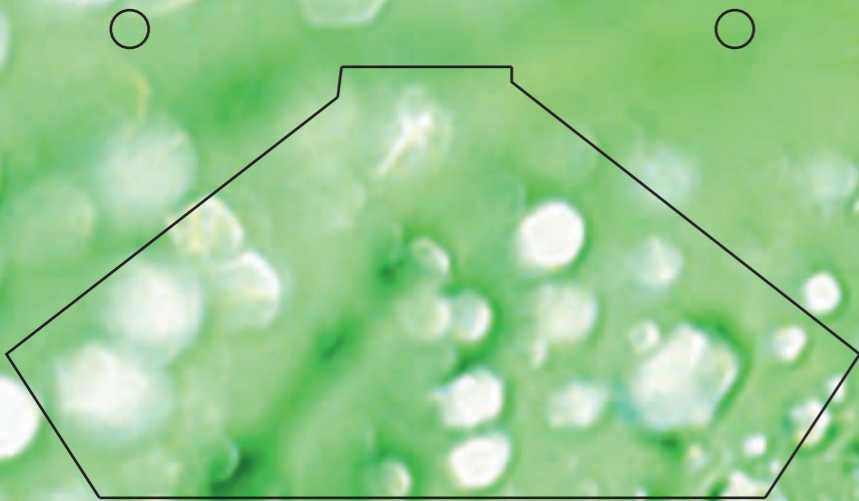

- D** Viereckregner Vario 50
- GB** Oscillating Sprinkler Vario 50
- F** Arroseur oscillant Vario 50
- NL** Zwenksproeier Vario 50
- S** Spridare Vario 50
- DK** Vippevander Vario 50
- FI** Sadetin Vario 50
- N** Spreder Vario 50
- I** Mini-oscillante Vario 50
- E** Aspersor oscilante Vario 50
- P** Aspersor de 4 superficies Vario 50
- PL** Zraszacz wahadłowy Vario 50
- H** Vario 50 négyzetesóztető
- CZ** Čtyřplošný zavlažovač Vario 50
- GR** Ποτιστικό Vario 50
- RUS** Осциллирующий дождеватель Vario 50
- SLO** Pravokotni zalivalnik Vario 50
- HR** Naprava za zalijevanje četverokutnih površina Vario 50
- SRB/BIH** Oscilirajuća prskalica Vario 50
- UA** Дощувач осцилюючий Vario 50
- RO** Mini-Aspersor oscilant Vario 50
- TR** Salımlı Fiskiye Vario 50
- BG** Осцилиращ разпръсквач Vario 50
- AL** Vaditese ne forme shatervani vario 50
- EST** Võnkuv sprinkler Vario 50
- LT** Svyruojantis laistymo purkštuvas "Vario 50"
- LV** Pulsējošais laistītājs Vario 50

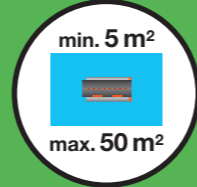
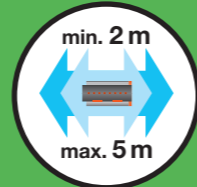

1x

Ø 13 mm, 1/2"

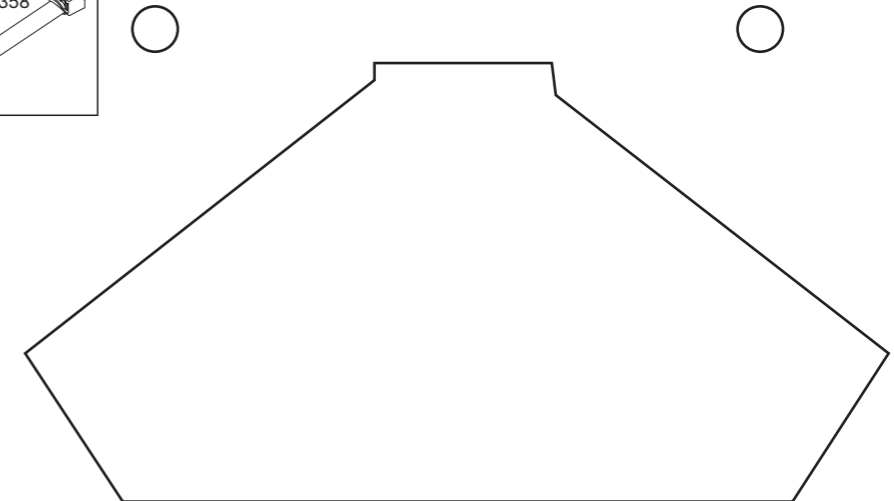
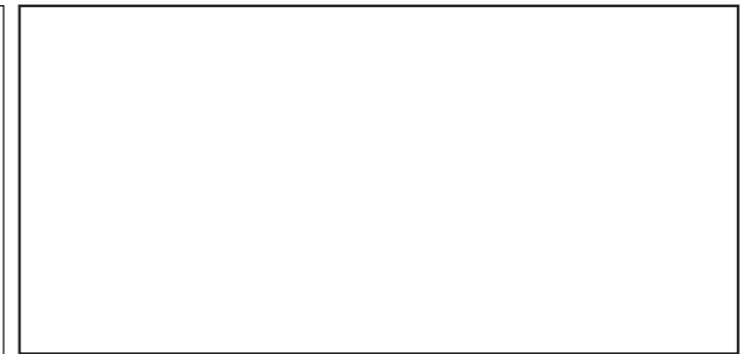
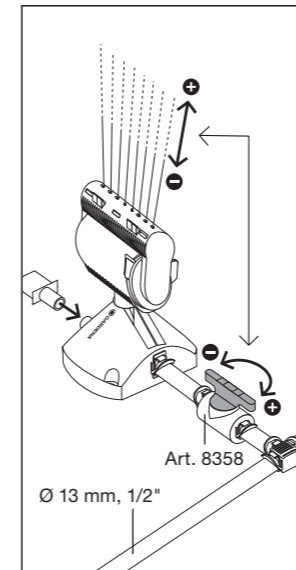
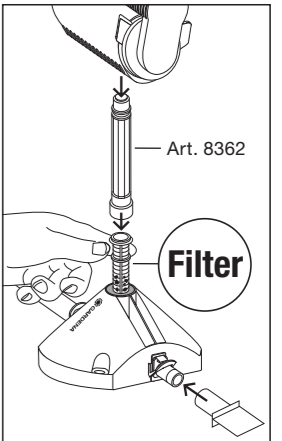
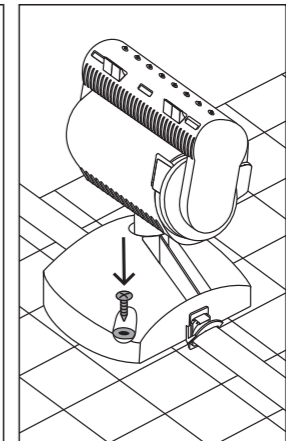
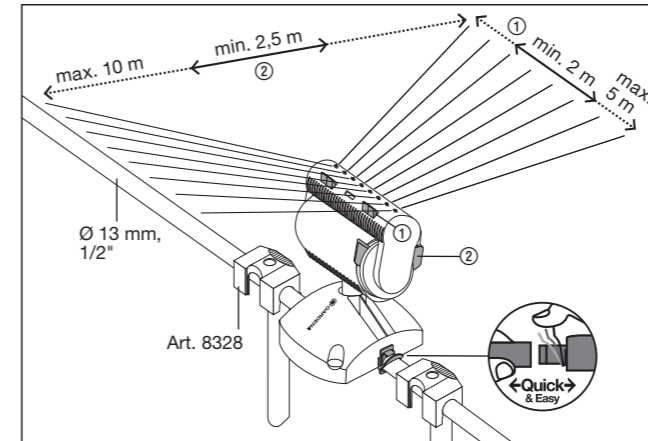

GARDENA
 8360-20.950.04/2009
 Made in Germany

GARDENA GmbH
 Hans-Lorenser-Str. 40
 D-89079 Ulm
 Germany
 www.gardena.com



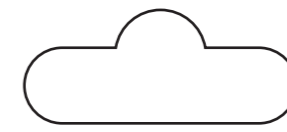
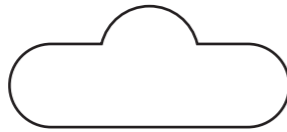

D EU-Konformitätserklärung
Der Unterzeichnete, GARDENA Manufacturing GmbH, Hans-Lorensen-Str. 40, D-89079 Ulm, bestätigt, dass der Viereckregner 8360 den EU-Richtlinien 98/37/EC:1998 und 2006/42/EC:2006 entspricht.

GB EU Certificate of Conformity
The undersigned GARDENA Manufacturing GmbH, Hans-Lorensen-Str. 40, D-89079 Ulm, hereby certifies that, when leaving our factory the oscillating sprinkler 8360 is in accordance with the EU directives 98/37/EC:1998 and 2006/42/EC:2006.

F Déclaration de conformité aux directives européennes et aux réglementations prises pour sa transposition.
Le fabricant GARDENA Manufacturing GmbH, Hans-Lorensen-Str. 40, D-89079 Ulm, déclare que l'arroseur oscillant 8360 est conforme aux directives européennes 98/37/EC:1998 et 2006/42/EC:2006.

NL EU-overeenstemmingsverklaring
Ondergetekende, GARDENA Manufacturing GmbH, Hans-Lorensen-Str. 40, D-89079 Ulm, bevestigt, dat de zwenksproeier 8360 voldoet aan de EU-richtlijnen 98/37/EC:1998 en 2006/42/EC:2006.

S EU Försäkran om överensstämmelse
Undertecknade GARDENA Manufacturing GmbH, Hans-Lorensen-Strasse 40, D-89079 Ulm, intygar härmed att Spridare Vario 50 var i förenlighet med EU direktiv 98/37/EC:1998 och 2006/42/EC:2006 när den lämnade fabriken.

DK Overensstemmelseserklæring
Undertegnede GARDENA Manufacturing GmbH, Hans-Lorensen-Strasse 40, D-89079 Ulm, bekræfter hermed, at vippevander 8360 var i overensstemmelse med EU direktiv 98/37/EC:1998 og 2006/42/EC:2006, da den forlod vores fabrik.

I Dichiarazione di conformità alle norme UE
La sottoscritta GARDENA Manufacturing GmbH, Hans-Lorensen-Str. 40, D-89079 Ulm, con la presente certifica che il Mini-oscillante 8360 è conforme alle direttive UE 98/37/EC:1998 e 2006/42/EC:2006.

E CEE Certificado de Conformidad.
El que suscribe, GARDENA Manufacturing GmbH, Hans-Lorensen-Str. 40, D-89079 Ulm declara que el aspersor oscilante 8360 cumple con la normativa CEE de maquinaria 98/37/EC: 1998 y 2006/42/EC: 2006

P Certificado conformidade UE
A abaixo assinada, GARDENA Manufacturing GmbH, Hans-Lorensen-Str. 40, D-89079 Ulm, certifica que o aspersor oscilante 8360, está em conformidade com as directivas da UE 98/37/EC: 1998 e 2006/42/EC: 2006

FI EU:n yhdenmukaisuustodistus:
Allekirjoittanut GARDENA Manufacturing GmbH, Hans-Lorensen-Str. 40, D-89079 Ulm, todistaa, että sadetin, tuote 8360, tehtaalta lähtessään vastaa EU-direktiivien 98/37/EC:1998 ja 2006/42/EC:2006 vaatimuksia.

PL Deklaracja zgodności Unii Europejskiej
Niżej podpisany GARDENA Manufacturing GmbH, Hans-Lorensen-Str. 40, D-89079 Ulm niniejszym potwierdza, że zraszacz wahadłowy 8360 w wykonaniu wprowadzonym przez nas do obrotu spełnia wymogi dyrektyw Unii Europejskiej 98/37/EC:1998 oraz 2006/42/EC:2006.

H EU megfelelőségi nyilatkozat
Alulírott GARDENA Manufacturing GmbH, Hans-Lorensen-Str. 40, D-89079 Ulm, igazolja, hogy a 8360 cikkszámú négyzetes öntöző 98/37/EC:1998 és a 2006/42/EC:2006 EU szabványoknak megfelel.

CZ EU - prohlášení o shodě
Podepsaná, GARDENA Manufacturing GmbH, Hans-Lorensen-Str. 40, D-89079 Ulm, potvrzuje, že čtyřplošný zavlažovač č.v. 8360 splňuje směrnici EU 98/37/EC:1998 a 2006/42/EC:2006.

SK EU - vyhlásenie o zhode
Podpísaná, GARDENA Manufacturing GmbH, Hans-Lorensen-Str. 40, D-89079 Ulm, potvrdzuje, že štvorplošný zavlažovač č.v. 8360 spĺňa smernicu EU 98/37/EC:1998 a 2006/42/EC:2006.

GR Δήλωση συμμόρφωσης ΕΚ
Η υπογεγραμμένη GARDENA Manufacturing GmbH, Hans-Lorensen-Str.40, D-89079 Ulm, πιστοποιεί ότι το ποτιστικό 8360, όταν φεύγει από το εργοστάσιο μας, είναι κατασκευασμένο σύμφωνα με τις προδιαγραφές της Ευρωπαϊκής Κοινότητας 98/37/EC:1998 και 2006/42/EC:2006.

SLO EU izjava o skladnosti
Podpisana GARDENA Manufacturing GmbH, Hans-Lorensen-Str. 40, D-89079 Ulm, potrjuje, da v nadaljevanju opisane naprave v naši izvedbi na trgu izpolnjujejo zahteve usklajenih direktiv EU 98/37/EC:1998 in 2006/42/EC:2006.

RO UE Certificat de conformitate
Subsemnata GARDENA Manufacturing GmbH, Hans-Lorensen-Str. 40, D – 89079 Ulm, certifica prin prezenta ca, la iesirea din fabrica noastra mini-aspersorul oscilant 8360 este in concordanta cu directivele UE 98/37/EC: 1998 si 2006/42/EC:2006.

BG EC Декларация за съответствие
Производителят GARDENA Manufacturing GmbH; Hans-Lorensen-Str. 40, D-89079 Ulm, декларира, че Осцилиращият разпръсквач 8360 отговаря на европейските директиви 98/37/EC: 1998 и 2006/42/EC: 2006.

EST EL-vastavusertifikaat
Allakirjutanu, GARDENA Manufacturing GmbH, Hans-Lorensen-Str. 40, D-89079 Ulm, tõendab, et tehasesest väljuedes vastab sprinkler 8360 kõiki dele EL-direktiividele 98/37/EC:1998 ja 2006/42/EC:2006.

LT ES Atitikties sertifikatas
Žemiau pasirašiusi GARDENA Manufacturing GmbH, Hans-Lorensen-Str. 40, D-89079 Ulm, patvirtina, kad svyruojantis laistymo purkštuvus 8360 atitinka Europos Sąjungos direktyvas 98/37/EC:1998 ir 2006/42/EC:2006.

LV ES Atbilstības sertifikāts
GARDENA Manufacturing GmbH, Hans-Lorensen-Str. 40, D-89079 Ulm, ar šo apstiprina, ka atstājot rūpnīcu pulsējošais laistītājs 8360 atbilst ES direktīvai 98/37/EC:1998 un 2006/42/EC:2006.

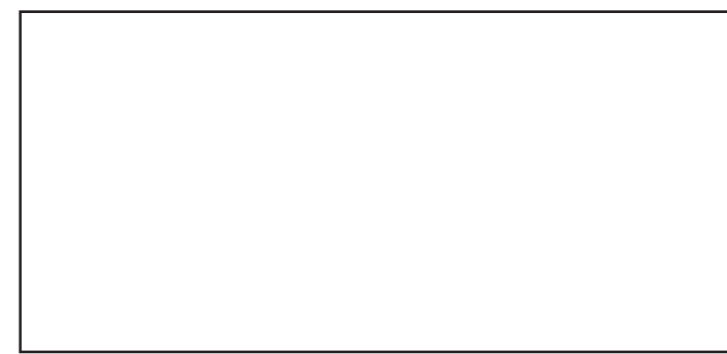

Harmonisierte EN:
DIN EN ISO 12100-1
DIN EN ISO 12100-2

Ulm, den 01.04.2009

Peter Lameli
Vice President

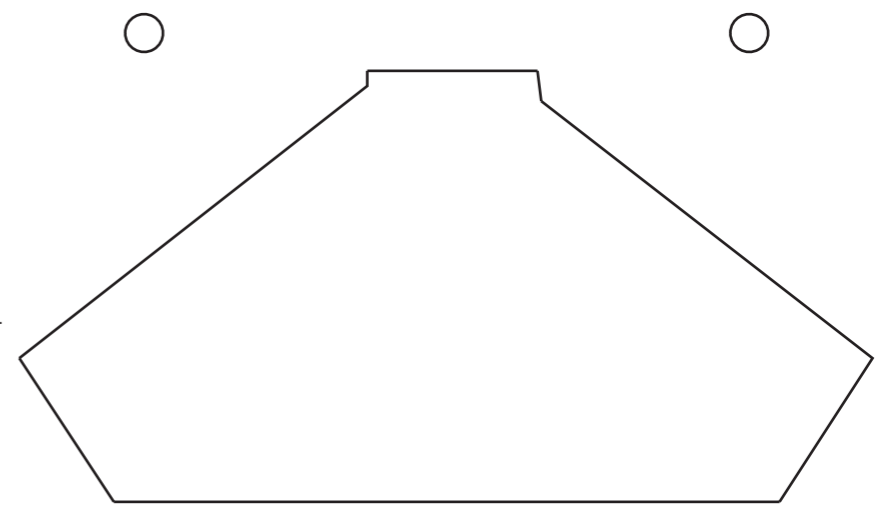
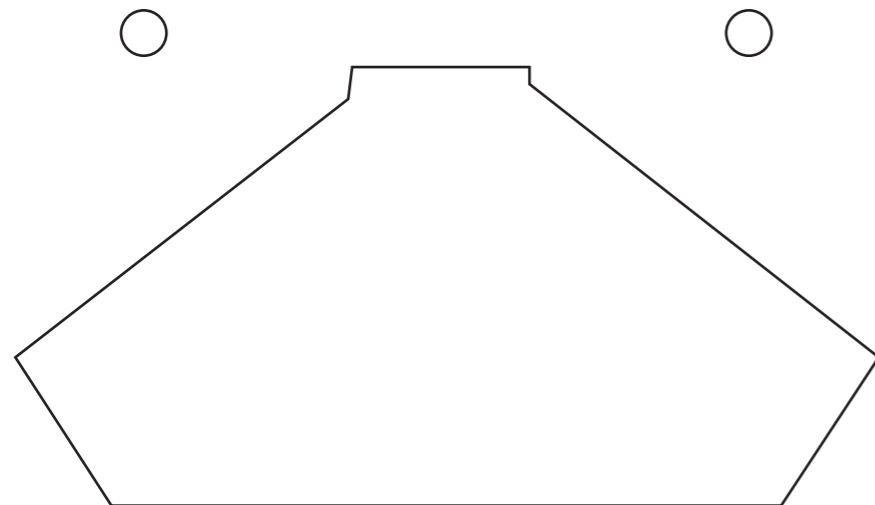

PL Husqvarna Poland Spółka z o.o.
ul. Wysockiego 15 b
03-371 Warszawa
Oddział w Szymanowie
Szymanów 9 d
05-532 Baniocha

H Forgalmazó:
Husqvarna Magyarorszag Kft.
1044 Budapest
Ezred u. 1-3.

CZ/SK Husqvarna Česko s.co.
odštěpný závod GARDENA
Tuřanka 1222/115
627 00 Brno

GR HUSQVARNA ΕΛΛΑΣ Α.Ε.Β.Ε.
Υπό Νηλεότου 33Α
Βλ. Πλ. Κορομπίου
19 400 Κορυμπ Αττικής

RUS Импортёр: ООО "Хускварна"
141400, Московская обл.,
г. Химки, улица Ленинградская,
владение 39, Химки Бизнес Парк,
Здание II, 4 этаж.

SLO GARDENA d.o.o.
Brodšče 15
1236 Trzin
Slovenija

HR SILK ADRIA d.o.o.
Josipa Lončara 3
10090 Zagreb
Tel: 00385 1 3794 580
Fax: 00385 1 3794 581
Zemlja porijekla: Njemačka

SRB Uvoznik i distributer: Domel d.o.o.
Savski nasip 7, Beograd
Zemlja porekla/uvoza: Nemačka

BIH Uvoznik i distributer SILK TRADE d.o.o.
Industrijska zona Bukva bb,
74260 Tešanj
Country of origin: Njemačka

UA ТОВ "Хускварна Україна"
вул. Васильківська, 34, офіс 204-г
03022, Київ
Україна

TR GARDENA Dost Dış Ticaret Müessesilik A.Ş.
Sanayi Cad. Adil Sok. No:1/B Kartal
34873 Istanbul

BG Вносител:
Хускварна България ЕООД
бул. "Андрей Ляпчев" No 72
1799 София
тел: 02 / 9753076
факс: 02 / 8099413
Производител: Гардена, Германия

AL EIG Sh.p.k - Rruga. Siri Kodra,
Blloku i Magazinave,
Frigoriferi Metalik Blu,
4000 Tirana - Albania

EST Husqvarna Eesti OÜ
Kesk tee 10, Aaviku küla
Rae vald, Harju maakond
75305 Estonia

LT UAB Husqvarna Lietuva
Ateities pl. 77 c
LT-52104 Kaunas

LV Husqvarna Latvija
Bakūžu iela 6
LV-1024 Rīga