

T 1030 plus Art. 1860

- GB Operating Instructions**  
Water Timer Electronic
- 
- F Mode d'emploi**  
Programmateur d'arrosage
- 
- NL Gebruiksaanwijzing**  
Elektronische watertimer
- 
- S Bruksanvisning**  
Bevattningstimer
- 
- DK Brugsanvisning**  
Vandingsur
- 
- RUS Инструкция по эксплуатации**  
Дождевальнй таймер

# GARDENA Water Timer electronic T 1030 plus

Welcome to the Garden of GARDENA...



Translation of the original instructions from German. Please read these operating instructions carefully and observe the notes given. Use these instructions to familiarise yourself with the Water Timer electronic and its proper use as well as the notes on safety.



For safety reasons, children and young people under 16 as well as anyone who is not familiar with these operating instructions should not use the Water Timer.

→ Please keep these operating instructions in a safe place.

## Contents

1. Where to Use Your GARDENA Water Timer T 1030 plus	2
2. Safety Instructions	2
3. Function	3
4. Putting Your Water Timer into Operation	4
5. Operating Your Water Timer	5
6. Putting Your Water Timer Out of Operation	7
7. Maintenance	7
8. Troubleshooting	7
9. Available Accessories	8
10. Technical Data	8
11. Service / Warranty	9

## 1. Where to Use Your GARDENA Water Timer T1030 plus

### Intended use:

The GARDENA Water Timer is intended for private use in domestic and hobby gardens, exclusively for outdoor use, to control sprinklers and watering systems. The Water Timer can be used for automatic watering during holidays.

### Please note:



**The GARDENA Water Timer must not be used for industrial purposes or in conjunction with chemicals, foodstuffs, easily flammable and explosive materials.**

## 2. Safety Instructions

### Battery:

To ensure the Water Timer runs safely, only a 9V alkaline manganese battery (alkaline) type IEC 6LR61 must be used.

The battery must be exchanged in time to prevent the Water Timer failing due to a low battery when you are away for longer periods of time. Make sure that the time the battery

has been in operation and the time you are planning to be away does not add up to more than a year.

Before a long period of absence (e.g. holidays), the battery should be tested (see 4. Putting Your Water Timer into Operation).

**Setting up:**

**Warning!**

The Water Timer must not be used indoors.

→ Only use the Water Timer outdoors.

The Water Timer must only be set up vertically with the sleeve nut to the top to prevent water penetrating into the battery compartment.

The minimum water output to ensure that the Water Timer functions correctly is 20 - 30 l/h.

For example, at least 10 x 2-litre Drip Heads are required to control the Micro-Drip-System.

The max. temperature for the water flow is 40 °C.

→ Only use clear fresh water.

The minimum operating pressure is 0.5 bar, the maximum operating pressure is 12 bar.

Avoid tensile strain.

→ Do not pull the hose connected to the Water Timer.

**Programming**

→ Program the Water Timer with the tap turned off.

In this way you can avoid getting wet when trying out the manual On/Off function (man. On/Off). You can remove the control unit from the housing to program the Water Timer.

If the controller is removed when the valve is open, the valve remains open until the controller is fitted again.

### 3. Function

With the Water Timer, the garden can be watered fully automatically up to 3 times a day at any time of day (every 8 hours). Sprinklers, a sprinkler system or a drip head watering system can be used for watering.

The Water Timer carries out watering fully automatically according to the set program and can therefore also be used during holidays. Evaporation is lowest in the early morning or late evening.

**User interface:**

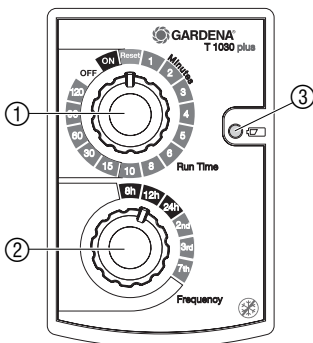

The watering program is simply set via the controls.

- ① **Run-Time** control knob (watering time)
- ② **Frequency** control knob (watering frequency)
- ③ **Battery level LED**

When the Battery display flashes continually, the battery is empty and the valve is no longer opened.

**A valve opened by the program is also closed again with an empty battery.**

The battery display is reset when the battery is changed.

→ Replace battery (see 4. Putting Your Water Timer into Operation "Insert battery").

→ Test battery (see 4. Putting Your Water Timer into Operation "Test battery").

## 4. Putting Your Water Timer into Operation

### Insert battery:

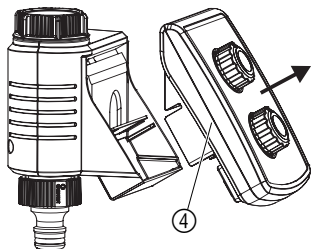

The Water Timer may only be operated with a 9 V alkali-manganese (alkaline) battery type IEC 6LR61.

1. Remove controller ④ from the housing of the Water Timer.
2. Insert battery in the battery compartment ⑤. **Observe correct polarity P.**
3. Install controller ④ on the housing again.

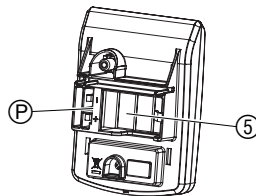

### Test battery:

Before a long period of absence (e.g. holidays), the battery should be tested. So that the water running off cannot cause damage, a specific outlet is to be provided on the Water Timer (connect hose, place bucket underneath etc.).

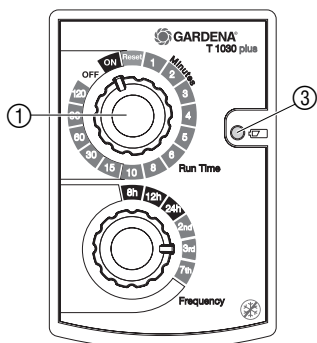

1. Open tap.
2. Turn **Run-Time** control knob ① clockwise to **ON**.  
*The valve opens.*
3. Turn **Run-Time** control knob ① to **OFF**.  
*The valve closes.*

Battery sufficiently full	Battery almost empty	Battery flat
Valve opens.	Valve opens.	Valve does not open.
Battery level LED ③ does not flash.	Battery level LED ③ flashes 5 times.	Battery level LED ③ flashes permanently.
The Water Timer is guaranteed to work for a minimum of 4 more weeks.	The Water Timer will continue to work for no more than 4 weeks.	The Water Timer stops working.
	It is advisable to change the battery.	The battery must be changed.

### Connect Water Timer:

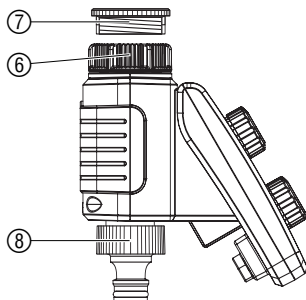

The Water Timer is fitted with a sleeve nut ⑥ for taps with G 1" (33.3 mm) thread. The adaptor supplied ⑦ allows the Water Timer to be connected to taps with a G 3/4" (26.5 mm) thread.

1. **For tap with a G 3/4" (26.5 mm) thread:**  
Screw adaptor ⑦ on to the tap manually (do not use pliers).
2. Screw sleeve nut ⑥ of the Water Timer on to the adaptor thread by hand (do not use pliers).
3. Screw tap connector ⑧ on to the Water Timer.

**Connect soil moisture or rain sensor (optional):**

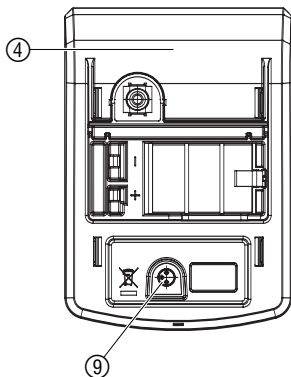

In addition to time-based watering, it is also possible to include the soil moisture or rain sensor in the watering programs.

If the soil is moist enough, the program will be stopped, or a program will be prevented from starting. Manual operation via **man. On/Off** is unaffected by this.

1. Remove controller ④ from the housing of the Water Timer.
2. Place soil moisture sensor **in** the watered area  
 – or –  
 place rain sensor (with extension cable if necessary) **outside** the watered area.
3. Insert the sensor in the sensor connection ⑨ of the Water Timer.

An adapter cable may be required to connect older sensors, which can be purchased from GARDENA Service, **GARDENA Adapter cable Art. No. 1189-00.600.45.**

**Fit anti-theft device (optional):**

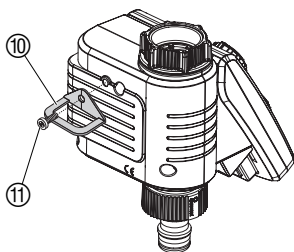

To secure your Water Timer against theft, you can obtain the **GARDENA Anti-theft device Art. No. 1815-00.791.00** from GARDENA Service.

1. Screw clamp ⑩ with screw ⑪ firmly to the back of the Water Timer.
2. Use clamp ⑩ e.g. for fixing a chain.

It is no longer possible to remove the screw after it has been screwed in.

## 5. Operating Your Water Timer

**Set watering program:**

To set the program, the controller can be removed and mobile programming can be carried out (see 4. Putting Your Water Timer into Operation "Insert battery").

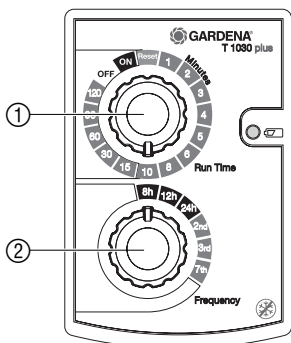

**Set watering duration:**

The watering duration can be set between 1 and 120 minutes in 13 steps.

→ Turn **Run Time** control knob ① to the required watering duration (e.g. 10 minutes).

**Set watering frequency:**

The watering frequency can be set between 8 hours (8h) and every 7<sup>th</sup> day (7th) in 6 steps.

→ Turn **Frequency** control knob ② to the required watering frequency (e.g. every 8 hours = 8h).

**Watering start time:**

5 seconds after setting the watering frequency, the set values are accepted and first watering begins. **The time at which this happens is the future watering start time.**

According to the setting of the **Frequency** control knob ②, the next watering starts after the set frequency has elapsed (e.g. 8h = after 8, 16, 24... hours).

If a sensor inserted in the Water Timer indicates moist, the programmed irrigation is not carried out.

### Change watering start time:

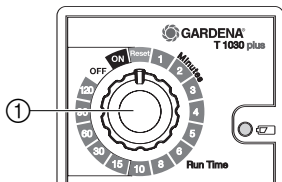

Set watering start time again.

1. Turn **Run-Time** control knob ① counter-clockwise to **Reset**.  
*After 2 seconds, the current time is set as the new watering start time.*
2. Turn **Run-Time** control knob ① back to the desired watering period again.

### Change watering duration:

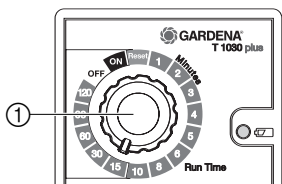

On hot or cool days, the watering duration can be changed before the program starts, without the watering frequency and watering start time being changed.

→ Turn **Run Time** control knob ① to the altered watering duration (e.g.: 15 minutes).

**If the watering duration is changed while a program is running, the following applies:**

- If the altered watering duration is longer than the old watering period, the new watering duration applies.
- If the altered watering duration is shorter than the old watering period, watering is ended after one minute.

### Manual watering (ON):

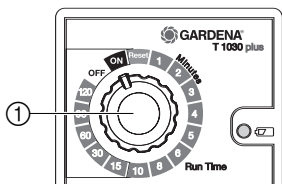

**The valve can be opened or closed manually at any time.** The watering start time and watering frequency are retained.

→ Turn **Run-Time** control knob ① **clockwise** to **ON**.

*The valve is opened for 30 minutes, independently of the program set.*

To reactivate the set program, the previously set watering duration must be set again.

### Bad weather function (OFF):

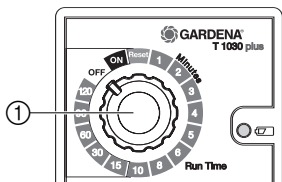

**The valve can be closed manually at any time.** A program-controlled open valve can be closed prematurely without the watering start time and watering frequency being changed.

→ Turn **Run-Time** control knob ① to **OFF**.

*The valve is closed or remains closed independently of the program set.*

To reactivate the set program, the previously set watering duration must be set again.

## 6. Putting Your Water Timer Out of Operation

### Storage / Overwintering:



1. Turn **Run-Time** control knob to **OFF**.  
*The watering program is not run.*
2. Store the Water Timer in a dry, frost-free place.

### Disposal: *(in accordance with RL 2002/96/EC)*



The product must not be added to normal household waste. It must be disposed of in line with local environmental regulations.

→ Important: Make sure that the unit is disposed of via your municipal recycling collection centre.

### Disposing of flat batteries:

→ Please return flat batteries to a GARDENA dealer or dispose of them properly at your nearest recycling centre.

Only dispose of batteries when they are **flat**.

## 7. Maintenance

### Clean filter:

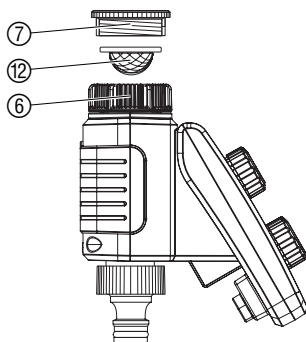

The filter ⑫ should be checked regularly and cleaned when necessary.

1. Unscrew sleeve nut ⑥ of the Water Timer by hand from the tap thread (do not use pliers).
2. If necessary unscrew the adaptor ⑦.
3. Remove filter ⑫ from sleeve nut ⑥ and clean.
4. Fit the Water Timer again (see 4. Putting Your Water Timer into Operation “Connecting Water Timer”).

## 8. Trouble-Shooting

Fault	Possible cause	Remedy
Not able to open manually using “ON/OFF”	Battery capacity too low (Battery status LED flashes).	→ Insert a new alkaline battery.
	Tap turned off.	→ Turn on tap.
Watering is not carried out	Program switched off: Turn <b>Run Time</b> control knob to <b>OFF</b> or <b>Reset</b> .	→ Turn <b>Run Time</b> control knob to the required watering duration.
	Watering was started manually and automatically ended after 30 mins. Turn <b>Run-Time</b> control knob to <b>ON</b> .	→ Turn <b>Run Time</b> control knob to the required watering duration.
	Battery capacity too low (Battery status LED flashes).	→ Insert a new alkaline battery.
	Battery incorrectly inserted.	→ Observe polarity (+/-).

<b>Fault</b>	<b>Possible cause</b>	<b>Remedy</b>
<b>Watering is not carried out</b>	A connected sensor indicates sufficient moisture.	→ Moisture level setting on soil moisture sensor.
	Tap turned off.	→ Turn on tap.
<b>Watering program is run at the wrong time</b>	Turned to Reset in between.	→ Set start time again (see 5. Operation).
<b>Battery used up after short period of operation</b>	Battery used not alkaline.	→ Use alkaline battery.



In the event of other faults please contact **GARDENA Service**.  
Repairs should only be carried out by **GARDENA service centres or dealers** authorised by **GARDENA**.

## 9. Available accessories

<b>GARDENA</b> Soil Moisture Sensor		<b>Art. No. 1188</b>
<b>GARDENA</b> Rain Sensor electronic		<b>Art. No. 1189</b>
<b>GARDENA</b> Anti-theft device		<b>Art. No. 1815-00.791.00</b> <b>From GARDENA Service</b>
<b>GARDENA</b> Adapter cable	(to connect older GARDENA sensors)	<b>Art. No. 1189-00.600.45</b> <b>From GARDENA Service</b>

## 10. Technical Data

<b>Min./max. operating pressure:</b>	0.5 bar / 12 bar
<b>Minimum flow rate:</b>	20 l/h
<b>Flow medium:</b>	Clear fresh water
<b>Max. liquid temperature:</b>	40 °C
<b>Number of program-controlled watering cycles per day:</b>	3 x (every 8 hrs.), 2 x (every 12 hrs.), 1 x (every 24 hrs.)
<b>Watering cycles per week:</b>	Every day, every 2nd, 3rd or 7th day
<b>Watering duration program:</b>	1, 2, 3, 4, 5, 6, 8, 10, 15, 30, 60, 90, 120 mins.
<b>Battery required:</b>	1 x 9V alkaline manganese (alkaline) battery type IEC 6LR61
<b>Operating time of the battery:</b>	approx. 1 year



## 11. Service / Warranty

---

GARDENA guarantees this product for 2 years (from date of purchase). This guarantee covers all serious defects of the unit that can be proved to be material or manufacturing faults.

Under warranty we will either replace the unit or repair it free of charge if the following conditions apply:

- The unit must have been handled properly and in keeping with the requirements of the operating instructions.
- Neither the purchaser or a non-authorised third party have attempted to repair the unit.
- Faults which occur as a result of incorrectly installed or leaking batteries are not covered by the guarantee.
- Damage caused by frost is not covered by the warranty.

This manufacturer's guarantee does not affect the user's existing warranty claims against the dealer/seller.

If you have any problems with your Water Timer, please contact our Customer Service or return the defective unit together with a short description of the problem directly to one of the GARDENA Service Centres listed on the back of this leaflet.

<b>GB</b> <i>Product Liability</i>	<p>We expressly point out that, in accordance with product liability law, we are not liable for any damage caused by our units if it is due to improper repair or if parts exchanged are not original GARDENA parts or parts approved by us, and, if the repairs were not carried out by a GARDENA Service Centre or an authorised specialist. The same applies to spare parts and accessories.</p>
<b>F</b> <i>Responsabilité</i>	<p>Nous vous signalons expressément que GARDENA n'est pas responsable des dommages causés par ses appareils, dans la mesure où ces dommages seraient causés suite à une réparation non conforme, dans la mesure où, lors d'un échange de pièces, les pièces d'origine GARDENA n'auraient pas été utilisées, ou si la réparation n'a pas été effectuée par le Service Après-Vente GARDENA ou l'un des Centres SAV agréés GARDENA. Ceci est également valable pour tout ajout de pièces et d'accessoires autres que ceux préconisés par GARDENA.</p>
<b>NL</b> <i>Productaansprakelijkheid</i>	<p>Wij wijzen er nadrukkelijk op, dat wij op grond van de wet aansprakelijkheid voor producten niet aansprakelijk zijn voor schade ontstaan door onze apparaten, indien deze door onvakkundige reparatie veroorzaakt zijn, of er bij het uitwisselen van onderdelen geen gebruik gemaakt werd van onze originele GARDENA onderdelen of door ons vrijgegeven onderdelen en de reparatie niet door de GARDENA technische dienst of de bevoegde vakman uitgevoerd werd. Ditzelfde geldt voor extra-onderdelen en accessoires.</p>
<b>S</b> <i>Produktansvar</i>	<p>Tillverkaren är inte ansvarig för skada som orsakats av produkten om skadan beror på att produkten har reparerats felaktigt eller om, vid reparation eller utbyte, andra än Original GARDENA reservdelar har använts. Samma sak gäller för kompletteringsdelar och tillbehör.</p>
<b>DK</b> <i>Produktansvar</i>	<p>Vi gør udtrykkeligt opmærksom på at i henhold til produktansvarsloven er vi ikke ansvarlige for skader forårsaget af vores udstyr, hvis det skyldes uautoriserede reparationer eller hvis dele er skiftet ud og der ikke er anvendt originale GARDENA dele eller dele godkendt af os, eller hvis reparationerne ikke er udført af GARDENA-service eller en autoriseret fagmand. Det samme gælder for ekstra udstyr og tilbehør.</p>
<b>RUS</b> <i>Ответственность за продукцию</i>	<p>Мы однозначно заявляем, что согласно Закону об ответственности за продукцию мы не несем ответственности за нанесенный нашим устройством ущерб, если он обусловлен неквалифицированным ремонтом или заменой деталей на запасные детали неоригинального происхождения GARDENA или неразрешенные нами детали или, если ремонт был произведен не службой сервиса GARDENA или неуполномоченным нами квалифицированным специалистом. Аналогичное относится также к дополнительным деталям и принадлежностям.</p>

<p><b>GB EU Certificate of Conformity</b></p> <p>The undersigned GARDENA International GmbH, Hans-Lorenser-Str. 40, D-89079 Ulm, hereby certifies that, when leaving our factory, the units indicated below are in accordance with the harmonised EU guidelines, EU standards of safety and product specific standards. This certificate becomes void if the units are modified without our approval.</p>	<p>Description of the unit: Water Timer Electronic          Désignation du matériel : Programmeur d'arrosage          Omschrijving van het apparaat : Elektronische watertimer          Produktbeskrivning: Bevattningstimer          Beskrivelse af enhederne : Vandingsur          Название устройства : Дождевальный таймер</p>
<p><b>F Certificat de conformité aux directives européennes</b></p> <p>Le constructeur, soussigné : GARDENA Manufacturing GmbH, Hans-Lorenser-Str. 40, D-89079 Ulm, déclare qu'à la sortie de ses usines le matériel neuf désigné ci-dessous était conforme aux prescriptions des directives européennes énoncées ci-après et conforme aux règles de sécurité et autres règles qui lui sont applicables dans le cadre de l'Union européenne. Toute modification portée sur ce produit sans l'accord express de GARDENA supprime la validité de ce certificat.</p>	<p>Type :          Type :          Typ : <b>T 1030 plus</b>          Typ :          Type :          Тип :</p> <p>Art. No. :          Référence :          Art. nr. : <b>1860</b>          Art. nr. :          Varenr. :          Арт. № :</p>
<p><b>NL EU-overeenstemmingsverklaring</b></p> <p>Ondergetekende GARDENA Manufacturing GmbH, Hans-Lorenser-Str. 40, D-89079 Ulm, bevestigt, dat het volgende genoemde apparaat in de door ons in de handel gebrachte uitvoering voldoet aan de eis van, en in overeenstemming is met de EU-richtlijnen, de EU-veiligheidsstandaard en de voor het product specifieke standaard. Bij een niet met ons afgestemde verandering aan het apparaat verliest deze verklaring haar geldigheid.</p>	<p>EU directives :          Directives européennes : <b>2004/108/EC</b>          EU-richtlijnen :          EU direktiv : <b>93/68/EC</b>          EU Retningslinier :          Директивы ЕС :</p>
<p><b>S EU Tillverkarintyg</b></p> <p>Undertecknad firma GARDENA International GmbH, Hans-Lorenser-Str. 40, D-89079 Ulm, intygar härmed att nedan nämnda produkter överensstämmer med EU:s direktiv, EU:s säkerhetsstandard och produktspecifikation. Detta intyg upphör att gälla om produkten ändras utan vårt tillstånd.</p>	<p>Year of CE marking :          Date d'apposition du marquage CE :          Installatiejaar van de CE-aanduiding : <b>2007</b>          CE-Märkningsår :          CE-Märkningsår :          Год разрешения маркировки          знаком CE :</p>
<p><b>DK EU Overensstemmelse certificat</b></p> <p>Undertegnede GARDENA International GmbH, Hans-Lorenser-Str. 40, D-89079 Ulm bekræfter hermed, at enheder listet herunder, ved afsendelse fra fabrikken, er i overensstemmelse med harmoniserede EU retningslinier, EU sikkerhedsstandarder og produktspecifikationsstandarder. Dette certifikat træder ud af kraft hvis enhederne er ændret uden vor godkendelse.</p>	<p>Ulm, 01.08.2007          Fait à Ulm, le 01.08.2007          Ulm, 01-08-2007          Ulm, 2007.08.01.          Ulm, 01.08.2007          Ульм, 01.08.2007</p> <p>Authorised representative          Représentant légal          Gemachtigde          Behörig Firmatecknare          Teknisk direktor          Уполномоченный представитель</p>
<p><b>RUS Свидетельство о соответствии ЕС</b></p> <p>Мы, нижеподписавшиеся GARDENA Manufacturing GmbH, Hans-Lorenser-Str. 40, D-89079 Ulm, настоящим подтверждаем, что нижеуказанное устройство, отгруженное с нашего предприятия, имеет исполнение, соответствующее требованиям согласованных директив ЕС, стандартам по технике безопасности ЕС и производственным стандартам. При несогласованном с нами изменении устройства настоящее свидетельство теряет силу.</p>	<p>          Peter Lameli          Vice President</p>

**Deutschland / Germany**

GARDENA  
Manufacturing GmbH  
Service Center  
Hans-Lorenser-Straße 40  
D-89079 Ulm  
Produktfragen:  
(+49) 731 490-123  
Reparaturen:  
(+49) 731 490-290  
service@gardena.com

**Argentina**

Argensem® S.A.  
Calle Colonia Japonesa s/n  
(1625) Loma Verde  
Escobar, Buenos Aires  
Phone: (+54) 34 88 49 40 40  
info@argensem.com.ar

**Australia**

Nylex Consumer Products  
50-70 Stanley Drive  
Somerton, Victoria, 3062  
Phone: (+61) 1800 658 276  
spare.parts@nylex.com.au

**Austria / Österreich**

GARDENA  
Österreich Ges.m.b.H.  
Stettnerweg 11-15  
2100 Korneuburg  
Tel.: (+43) 22 62 7 45 45 36  
kundendienst@gardena.at

**Belgium**

GARDENA Belgium NV/SA  
Sterrebeekstraat 163  
1930 Zaventem  
Phone: (+32) 2 7 20 92 12  
Mail: info@gardena.be

**Brazil**

Palash Comércio e  
Importação Ltda.  
Rua São João do Araguaia,  
338 – Jardim Califórnia –  
Barueri – SP – Brasil –  
CEP 06409-060  
Phone: (+55) 11 4198-9777  
eduardo@palash.com.br

**Bulgaria**

Хускварна България ЕООД  
1799 София  
Бул. „Андрей Ляпчев“ № 72  
Тел.: 02/ 8755148, 9753076  
www.husqvarna.bg

**Canada**

GARDENA Canada Ltd.  
100 Summerlea Road  
Brampton, Ontario L6T 4X3  
Phone: (+1) 905 792 9330  
info@gardenacanada.com

**Chile**

Antonio Martinic y Cia Ltda.  
Cassillas 272  
Centro de Cassillas  
Santiago de Chile  
Phone: (+56) 2 20 10 708  
garfar\_cl@yahoo.com

**Costa Rica**

Compania Exim  
Euroberoamericana S.A.  
Los Colegios, Moravia,  
200 metros al Sur del Colegio  
Saint Francis - San José  
Phone: (+506) 297 68 83  
exim\_euro@racsa.co.cr

**Croatia**

KLIS d.o.o.  
Stanciceva 79  
10419 Vukovina  
Phone: (+385) 1 622 777 0  
gardena@klis-trgovina.hr

**Cyprus**

FARMOKIPIKI LTD  
P.O. Box 7098  
74, Digeni Akritia Ave.  
1641 Nicosia  
Phone: (+357) 22 75 47 62  
condam@spidernet.com.cy

**Czech Republic**

GARDENA spol. s r.o.  
Tuřanka 115  
627 00 Brno  
Phone: (+420) 800 100 425  
gardena@gardenabrno.cz

**Denmark**

GARDENA Norden AB  
Salgsafdeling Danmark  
Box 9003  
S-200 39 Malmö  
info@gardena.dk

**Finland**

Oy Husqvarna Ab  
Lautatarhankatu 8b/ PL 3  
FI-00581 HELSINKI

**France**

GARDENA  
PARIS NORD 2  
69, rue de la Belle Etoile  
BP 57080  
ROISSY EN FRANCE  
95948 ROISSY CDG CEDEX  
Tél. (+33) 0826 101 455  
service.consommateurs@  
gardena.fr

**Great Britain**

Husqvarna UK Ltd  
Preston Road  
Aycliffe Industrial Park  
Newton Aycliffe  
County Durham  
DL5 6UP  
info.gardena@husqvarna.co.uk

**Greece**

Agrokip  
Psomadopoulos S.A.  
Ifaistou 33A  
Industrial Area Koropi  
194 00 Athens Greece  
V.A.T. EL093474846  
Phone: (+30) 210 6620 225  
service@agrokip.gr

**Hungary**

GARDENA  
Magyarország Kft.  
Késmárk utca 22  
1158 Budapest  
Phone: (+36) 80 20 40 33  
gardena@gardena.hu

**Iceland**

Ó. Johnson & Kaaber  
Tunguhalsi 1  
110 Reykjavik  
ooj@ojk.is

**Ireland**

Michael McLoughlin & Sons  
Hardware Limited  
Long Mile Road  
Dublin 12

**Italy**

GARDENA Italia S.p.A.  
Via Donizetti 22  
20020 Lainate (Mi)  
Phone: (+39) 02.93.94.79.1  
info@gardenaitalia.it

**Japan**

KAKUICHI Co. Ltd.  
Sumitomo Realty &  
Development Kojimachi  
BLDG., 8F  
5-1 Nibanncyo, Chiyoda-ku  
Tokyo 102-0084  
Phone: (+81) 33 264 4721  
m\_ishihara@kaku-ichi.co.jp

**Luxembourg**

Magasins Jules Neuberg  
39, rue Jacques Stas  
Luxembourg-Gasperich 2549  
Case Postale No. 12  
Luxembourg 2010  
Phone: (+352) 40 14 01  
api@neuberg.lu

**Netherlands**

GARDENA Nederland B.V.  
Postbus 50176  
1305 AD ALMERE  
Phone: (+31) 36 521 00 00  
info@gardena.nl

**Neth. Antilles**

Jonka Enterprises N.V.  
Sta. Rosa Weg 196  
P.O. Box 8200, Curaçao  
Phone: (+599) 9 767 66 55  
pgm@jonka.com

**New Zealand**

NYLEX New Zealand Limited  
Building 2, 118 Savill Drive  
Mangere, Auckland  
Phone: (+64) 0800 22 00 88  
spare.parts@nylex.com.au

**Norway**

GARDENA Norden AB  
Salgskontor Norge  
Karihaugveien 89  
1086 Oslo  
info@gardena.no

**Poland**

GARDENA Polska Sp. z o.o.  
Szymanów 9 d  
05-532 Baniocza  
Phone: (+48) 22 727 56 90  
gardena@gardena.pl

**Portugal**

GARDENA Portugal Lda.  
Sintra Business Park  
Edifício 1, Fracção 0-G  
2710-089 Sintra  
Phone: (+351) 21 922 85 30  
info@gardena.pt

**Romania**

MADEX INTERNATIONAL SRL  
Soseaua Odaii 117-123,  
Sector 1,  
București, RO 013603  
Phone: (+40) 21 352 76 03  
madex@ines.ro

**Russia / Россия**

ООО ГАРДЕНА РУС  
123007, г. Москва  
Хорошевское шоссе, д. 32А  
Тел.: (+7) 495 540 99 57  
info@gardena-rus.ru

**Singapore**

Hy-Ray PRIVATE LIMITED  
40 Jalan Pemimpin  
#02-08 Tat Ann Building  
Singapore 577185  
Phone: (+65) 6253 2277  
hyray@singnet.com.sg

**Slovak Republic**

GARDENA Slovensko, s.r.o.  
Panónska cesta 17  
851 04 Bratislava  
Phone: (+421) 263 453 722  
info@gardena.sk

**Slovenia**

GARDENA d.o.o.  
Brodšče 15  
1236 Trzin  
Phone: (+386) 1 580 93 32  
servis@gardena.si

**South Africa**

GARDENA  
South Africa (Pty.) Ltd.  
P.O. Box 11534  
Vorna Valley 1686  
Phone: (+27) 11 315 02 23  
sales@gardena.co.za

**Spain**

GARDENA IBÉRICA S.L.U.  
C/ Basauri, nº 6  
La Florida  
28023 Madrid  
Phone: (+34) 91 708 05 00  
atencioncliente@gardena.es

**Sweden**

GARDENA Norden AB  
Försäljningskontor Sverige  
Box 9003  
200 39 Malmö  
info@gardena.se

**Switzerland / Schweiz**

GARDENA (Schweiz) AG  
Bitzberg 1  
8184 Bächenbülach  
Phone: (+41) 848 800 464  
info@gardena.ch

**Turkey**

GARDENA / Dost Diş Ticaret  
Mümesillik A.Ş. Sanayi  
Çad. Adil Sokak No. 1  
Kartal - İstanbul  
Phone: (+90) 216 38 93 939  
info@gardena-dost.com.tr

**Ukraine / Україна**

ALTSEST JSC  
4 Petropavlivska Street  
Petropavlivska  
Borschahivka Town  
Kyivo Svyatoshyn Region  
08130, Ukraine  
Phone: (+380) 44 459 57 03  
uprr@altsest.kiev.ua

**USA**

Melnor Inc.  
3085 Shawnee Drive  
Winchester, VA 22604  
Phone: (+1) 540 722-9080  
service\_us@melnor.com

1860-28.960.01/1207  
© GARDENA  
Manufacturing GmbH  
D-89070 Ulm  
http://www.gardena.com