

EasyCut 48 PLUS Art. 8874

- | | | | |
|------------|---|------------|---|
| D | Betriebsanleitung
Elektro-Heckenschere | GR | Οδηγίες χρήσεως
Ηλεκτρικό μπουρντουροψάλιδο |
| GB | Operating Instructions
Electric Hedge Trimmer | RUS | Инструкция по эксплуатации
Электрические кусторезы |
| F | Mode d'emploi
Taille-haies électrique | SLO | Navodilo za uporabo
Električne škarje za živo mejo |
| NL | Instructies voor gebruik
Elektrische heggenschaar | HR | Upute za uporabu
Električne škare za živicu |
| S | Bruksanvisning
Elektrisk Häcksax | SRB | Uputstvo za rad |
| DK | Brugsanvisning
Elektrisk hækkeklipper | BIH | Električne makaze za živicu |
| FIN | Käyttöohje
Sähkökäyttöinen aitalaikkuri | UA | Інструкція з експлуатації
Електричний садовий секатор |
| N | Bruksanvisning
Elektrisk hekksaks | RO | Instrucțiuni de utilizare
Trimmer-ul electric de tuns garduri vii |
| I | Istruzioni per l'uso
Tagliasiepi elettrica | TR | Kullanım Klavuzu
Elektrikli Çit Kesici |
| E | Manual de instrucciones
Recortasetos eléctrico | BG | Инструкция за експлоатация
Електрически хросторез за жив плет |
| P | Instruções de utilização
Tesoura eléctrica de sebes | AL | Manual përdorimi
Gërshërë elektronike gardhishtesh |
| PL | Instrukcja obsługi
Elektryczne nożyce do żywopłotu | EST | Kasutusjuhend
Elektrilised hekikäärid |
| H | Használati utasítás
Elektromos sövénynyíró | LT | Ekspluatavimo instrukcija
Elektrinės gyvatvorių žirklys |
| CZ | Návod k použití
Elektrické nůžky na živý plot | LV | Lietošanas instrukcija
Elektriskais dzīvžogu trimmeris |
| SK | Návod na použitie
Elektrické nožnice na živý plot | | |

GARDENA Electric Hedge Trimmer

EasyCut 48 PLUS



Translation of the original instructions from German. Please read these operating instructions carefully and observe the notes given. Use these operating instructions to familiarise yourself with the hedge trimmer, its proper use and the notes on safety.



For safety reasons, children under the age of 16 and people not familiar with these operating instructions must not use this hedge trimmer. Persons with reduced physical or mental abilities may use the hedge trimmer only if they are supervised or instructed by a responsible person.

→ Please keep these operating instructions in a safe place.

Contents

1. Where to Use Your GARDENA Electric Hedge Trimmer	10
2. Safety Instructions	10
3. Assembly	13
4. Operation	13
5. Storage	14
6. Maintenance	15
7. Troubleshooting	15
8. Accessories	15
9. Technical Data	15
10. Service / Warranty	16

1. Where to Use Your GARDENA Electric Hedge Trimmer

Correct Use:

This GARDENA Electric Hedge Trimmer is intended for the cutting of hedges, shrubs and grass coverings in private domestic gardens and allotments.

Adherence to these operating instructions is a precondition for the correct use of the hedge trimmer.

Please note



WARNING ! Risk of injury !

The hedge trimmer must not be used for cutting lawns / lawn edges or for chopping up material for composting purposes.

2. Safety Instructions



If not used properly this product can be dangerous. The warnings and safety instructions must be followed to ensure reasonable safety and efficiency in using this product. The operator is responsible for following the warnings and instructions in this manual and on the product. Never use the product unless the guards provided by the manufacturer are in the correct position.

Explanation of Symbols on your product.



WARNING !



Read the user instructions carefully to make sure you understand all the controls and what they do.



Remove plug from the mains immediately if the cable is damaged or cut.



Do not expose to rain. Do not leave the product outdoors while it is raining.



The use of eye protection is recommended.

General Power Tool Safety Warnings



WARNING ! Read all safety warnings and all instructions. Failure to follow the warnings and instructions may result in electric shock, fire and/or serious injury.

Save all warnings and instructions for future reference.

The term "power tool" in the warnings refers to your mains operated (corded) power tool or battery-operated (cordless) power tool.

1) Work area safety

- a) **Keep work area clean and well lit.** Cluttered or dark areas invite accidents.
- b) **Do not operate power tools in explosive atmospheres, such as in the presence of flammable liquids, gases or dust.** Power tools create sparks which may ignite the dust or fumes.
- c) **Keep children and bystanders away while operating a power tool.** Distractions can cause you to lose control.

2) Electrical safety

- a) **Power tool plugs must match the outlet. Never modify the plug in any way. Do not use any adaptor plugs with earthed (grounded) power tools.** Unmodified plugs and matching outlets will reduce risk of electric shock.
- b) **Avoid body contact with earthed or grounded surfaces, such as pipes, radiators, ranges and refrigerators.** There is an increased risk of electric shock if your body is earthed or grounded.
- c) **Do not expose power tools to rain or wet conditions.** Water entering a power tool will increase the risk electric shock.
- d) **Do not abuse the cord. Never use the cord for carrying, pulling or unplugging the power tool. Keep cord away from heat, oil, sharp edges or moving parts. Damaged or entangled cords increase the risk of electric shock.**
- e) **When operating a power tool outdoors, use an extension cord suitable for outdoor use.** Use of a cord suitable for outdoor use reduces the risk of electric shock.
- f) **If operating a power tool in a damp location is unavoidable, use a residual current device (RCD) protected supply.** Use of an RCD reduces the risk of electric shock.

3) Personal safety

- a) **Stay alert, watch what you are doing and use common sense when operating a power tool. Do not use a power tool while you are tired or under the influence of drugs, alcohol or medication.** A moment of inattention while operating power tools may result in serious personal injury.
- b) **Use personal protective equipment. Always wear eye protection.** Protective equipment such as dust mask, non-skid safety shoes, hard hat, or hearing protection used for appropriate conditions will reduce personal injuries.

c) **Prevent unintentional starting.** Ensure the switch is in the off-position before connecting to power source and/or battery pack, picking up or carrying the tool. Carrying power tools with your finger on the switch or energising power tools that have the switch on invites accidents.

d) **Remove any adjusting key or wrench before turning the power tool on.** A wrench or a key left attached to a rotating part of the power tools may result in personal injury.

e) **Do not overreach.** Keep proper footing and balance at all times. This enables better control of the power tool in unexpected situations.

f) **Dress properly. Do not wear loose clothing or jewellery.** Keep your hair, clothing and gloves away from moving parts. Loose clothes, jewellery or long hair can be caught in moving parts.

g) **If devices are provided for the connection of dust extraction and collection facilities, ensure these are connected and properly used.** Use of dust collection can reduce dust-related hazards.

4) Power tool use and care

- a) **Do not force the power tool. Use the correct power tool for your application.** The correct power tool will do the job better and safer at the rate for which it was designed.
- b) **Do not use the power tool if the switch does not turn it on and off.** Any power tool that cannot be controlled with the switch is dangerous and must be repaired.
- c) **Disconnect the plug from the power source and/or the battery pack from the power tool before making any adjustments, changing accessories, or storing power tools.** Such preventive safety measures reduce the risk of starting the power tool accidentally.
- d) **Store idle power tools out of the reach of children and do not allow persons unfamiliar with the power tool or these instructions to operate the power tool.** Power tools are dangerous in the hands of untrained users.
- e) **Maintain power tools.** Check for misalignment or binding of moving parts, breakage of parts and any other condition that may affect the power tool's operation. If damaged, have the power tool repaired before use. Many accidents are caused by poorly maintained power tools.
- f) **Keep cutting tools sharp and clean.** Properly maintained cutting tools with sharp cutting edges are less likely to bind and are easier to control.
- g) **Use the power tool, accessories and tool bits etc. in accordance with these instructions, taking into account the working conditions and the work to be performed.** Use of the power tool for operations different from those intended could result in a hazardous situation.

5. Service

Have your power tool serviced by a qualified repair person using only identical replacement parts. This will ensure that the safety of the power tool is maintained.

Hedge trimmer safety warnings:

- **Keep all parts of the body away from the cutter blade. Do not remove cut material or hold material to be cut when blades are moving. Make sure the switch is off when clearing jammed material.** *A moment of inattention while operating the hedge trimmer may result in serious personal injury.*
- **Carry the hedge trimmer by the handle with the cutter blade stopped. When transporting or storing the hedge trimmer always fit the cutting device cover.** *Proper handling of the hedge trimmer will reduce possible personal injury from the cutter blades.*
- **Hold the power tool by insulated gripping surfaces only, because the cutter blade may contact hidden wiring or its own cord.** *Cutter blades contacting a "live" wire may make exposed metal parts of the power tool "live" and could give the operator an electric shock.*
- **Keep cable away from the cutting area.** *During operation the cable may be hidden in shrubs and can be accidentally cut by the blade.*

Additional Safety Recommendations

Work area safety

Only use the product in the manner and for the functions described in these instructions.

The operator or user is responsible for accidents or hazards occurring to other people or their property.

Electrical safety

The British Standards Institute recommend the use of a Residual Current Device (R.C.D.) with a tripping current of not more than 30 mA. Check your R.C.D. every time you use it.

Before use, examine cable for damage, replace it if there are signs of damage or ageing.

Do not use the product if the electric cables are damaged or worn.

Immediately disconnect from the mains electricity supply if the cable is cut, or the insulation is damaged. Do not touch the electric cable until the electrical supply has been disconnected.

Your electric cable must be untangled, tangled cables can overheat and reduce the efficiency of your product.

Always switch off at the mains before disconnecting any plug, cable connector or extension cable.

Switch off, remove plug from mains and examine electric supply cable for damage or ageing before winding cable for storage. Do not repair a damaged cable, replace it with a new one.

Always wind cable carefully, avoiding kinking.

Use only on AC mains supply voltage shown on the product rating label.

Under no circumstances should an earth be connected to any part of the product.

Cables

Use only permitted extension cables as per HD 516.

→ Ask your electrical specialist.

Personal safety

Always wear suitable clothing, gloves, and stout shoes.

Thoroughly inspect the area where the product is to be used and remove all wires and other foreign objects.

Before using the machine and after any impact, check for signs of wear or damage and repair as necessary.

Never attempt to use an incomplete product or one with an unauthorised modification.

Power tool use and care

Know how to stop the product quickly in an emergency.

Never hold the product by the guard.

Do not use the Hedge Trimmer if the protection equipment (hand protection, 2-hand safety switch, protection cover, quick blade-stop) are damaged.

Do not use ladders whilst operating the product.

Remove the plug from the mains :

- before leaving the product unattended for any period;
- before clearing a blockage;
- before checking, cleaning or working on the appliance;
- if you hit an object. Do not use your product until you are sure that the entire product is in a safe operating condition;
- if the product starts to vibrate abnormally. Check immediately. Excessive vibration can cause injury.
- before passing to another person.

Maintenance and storage



RISK OF INJURY !

Do not touch blades.

→ **When finishing or interrupting work push up protection cover.**

Keep all nuts, bolts and screws secure to be sure the hedge trimmer is in safe working condition.

3. Assembly

Fitting the front handle:



ATTENTION! Safety guard!

The guide handle ① is only a safety guard for the 2-handed trigger when the spring ⑤ is correctly inserted.

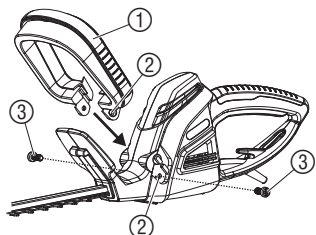

1. Insert the wide side of the spring ⑤ into the lower casing ① and the lower side into the upper casing ② and close the guide handle ①.
2. Push the guide handle ① over the slot in the hedge trimmer and ensure it is fully in place and the handle hole ② is lined up with the threaded hole ②.
3. Secure the guide handle ① to the hedge trimmer using the two screws ③.

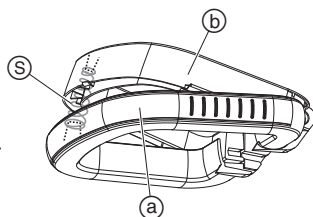

4. Operation

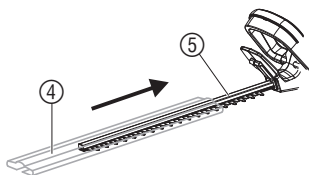

DANGER! Risk of physical injury!

- Always disconnect the extension cable ⑦ from the mains and slide the protective cover ④ over the trimmer blade ⑤ before connecting.
- Never take hold of the protective cover ④ when connecting the hedge trimmer.

Connecting the Hedge Trimmer:

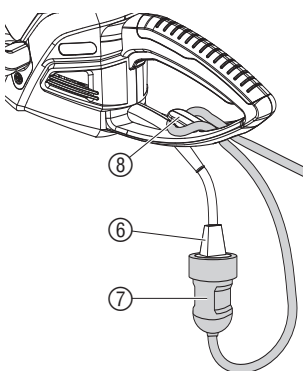

DANGER! Risk of electric shock!

- To avoid damage to the the mains cord ⑥ the extension cable ⑦ must be inserted into the cable lock ⑧.
- Always insert the extension cable ⑦ into the cable lock ⑧.

1. Loop the extension cable ⑦, insert the loop into the cable lock ⑧ and pull tight.
2. Insert the plug of the mains cord ⑥ into the socket of the extension cable ⑦.
3. Plug the extension cable ⑦ into a 230 V mains power supply.

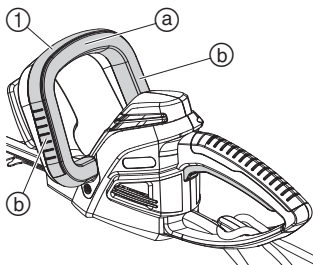
Working positions:

The hedge trimmer can be operated in 3 working positions.

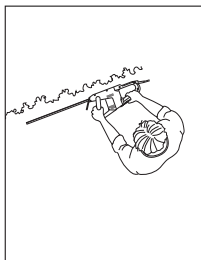
**Side trimming:**

→ Take guide handle ① at the side ②.

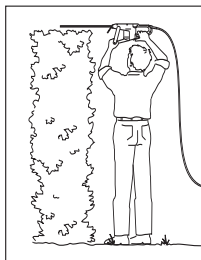
**High trimming:**

→ Take guide handle ① at the top ③.

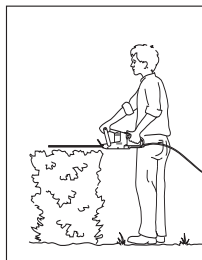
**Low trimming:**

→ Take guide handle ① at the top ④.

Starting the Hedge Trimmer:**DANGER ! Risk of physical injury!**

If the Hedge Trimmer does not switch off automatically, there is a risk of lacerations.

→ Never override the safety devices (e.g. by strapping down one of the start buttons).

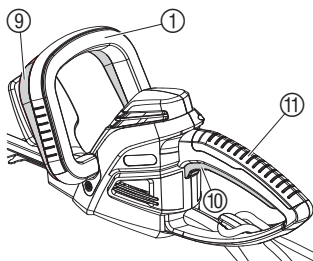
**Starting the Hedge Trimmer:**

The hedge trimmer is fitted with a two-handed safety device (2 start buttons) to prevent the unit from being turned on by accident.

1. Remove the protective cover ④ from blade.
2. Hold the guide handle ① with one hand and press the start button ⑨.
3. Hold the main handle ⑪ with the other hand and press the start button ⑩.

The hedge trimmer will start.

Switching the Hedge Trimmer off:

1. Release the two start buttons ⑨ / ⑩.
2. Slide the protective cover ④ over the cutter blade ⑤.

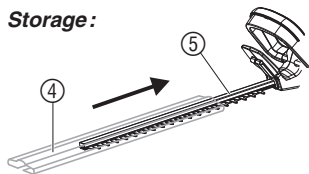
5. Storage**Storage:**

The hedge trimmer must be stored out of the reach of children.

1. Disconnect the mains plug.
2. Clean the hedge trimmer (see 6. Maintenance) and slide the protective cover ④ over the cutter blade ⑤.
3. Store the hedge trimmer in a dry, frost free place.

Disposal:

(in accordance with
RL2002/96/EC)



The product must not be added to normal household waste. It must be disposed of in line with local environmental regulations.

→ Important: Make sure that the unit is disposed of via your municipal recycling collection centre.

6. Maintenance

Cleaning the Hedge Trimmer:

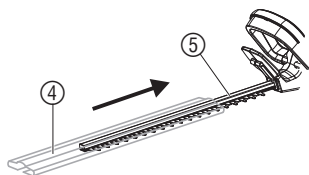

DANGER ! Risk of physical injury / electric shock !

→ Always unplug the mains plug and slide the protective cover ④ over the cutter blade ⑤ before carrying out maintenance work.

→ Do not clean the hedge trimmer under running water (especially high pressure).

1. Clean the hedge trimmer with a damp cloth.
2. Lubricate the trimmer blade ⑤ with a low viscosity oil (e.g. GARDENA spray-oil **Art. 2366**). Avoid contact with the plastic parts.

7. Troubleshooting



DANGER ! Electric shock !

→ Always unplug the mains plug and slide the protective cover ④ over the cutter blade ⑤ before troubleshooting.

Fault	Possible Cause	Remedy
Hedge trimmer does not start	Extension cable not plugged in or is damaged.	→ Plug in the extension cable or if necessary replace it.
Hedge is not cleanly cut	Blade blunt or damaged.	→ Have blade replaced by GARDENA-Service.



In the event of other faults please contact GARDENA Service.

Repairs should only be carried out by GARDENA service centres or dealers authorised by GARDENA.

8. Accessories

GARDENA Maintenance Oil	Extends the life of the blade.	Art. 2366
-------------------------	--------------------------------	------------------

9. Technical Data

	EasyCut 48 PLUS (Art. 8874)
Power consumption, motor	550 W
Voltage / Frequency	230 V / 50 Hz
Strokes	2,400/min.
Length of cutter blade	48 cm
Tooth gap of cutter blade	27 mm
Weight	3.5 kg
Workplace related sound pressure level $L_{pA} 1)$	75 dB (A)

EasyCut 48 PLUS (Art. 8874)

Noise emission value L_{WA} 2)	measured 95 dB (A) / guaranteed 99 dB (A)
--	--

Hand/arm vibration a_{vhw} 1)	< 3.2 m/s ²
Uncertainty K_a	< 1.5 m/s ²

Measuring process complying with 1) EN 774 2) EU-directive 2000/14/EC. The stated vibration emission value has been measured according to a standardised test procedure and can be used for comparison of one electric power tool with another. It can also be used for preliminary evaluation of exposure. The vibration emission value can vary during actual use of the electric power tool.

10. Service / Warranty

GARDENA guarantees this product for 2 years (from date of purchase). This guarantee covers all serious defects of the unit that can be proved to be material or manufacturing faults. Under warranty we will either replace the unit or repair it free of charge if the following conditions apply:

- The unit must have been handled properly and in keeping with the requirements of the operating instructions.
- Neither the purchaser nor a non-authorized third party have attempted to repair the unit.

The blade and eccentric drive are wearing parts and are not covered by the guarantee.

This manufacturer's guarantee does not affect the user's existing warranty claims against the dealer/seller.

If a fault occurs with your hedge trimmer, please return the faulty unit together with the receipt and a description of the fault, with postage paid to the address of the Service Centre at the back of these operating instructions.

D Produkthaftung

Wir weisen ausdrücklich darauf hin, dass wir nach dem Produkthaftungsgesetz nicht für durch unsere Geräte hervorgerufene Schäden einzustehen haben, sofern diese durch unsachgemäße Reparatur verursacht oder bei einem Teileaustausch nicht unsere Original GARDENA Teile oder von uns freigegebene Teile verwendet werden und die Reparatur nicht vom GARDENA Service oder dem autorisierten Fachmann durchgeführt wird. Entsprechendes gilt für Ergänzungsstücke und Zubehör.

GB Product Liability

We expressly point out that, in accordance with the product liability law, we are not liable for any damage caused by our units if it is due to improper repair or if parts exchanged are not original GARDENA parts or parts approved by us, and, if the repairs were not carried out by a GARDENA Service Centre or an authorised specialist. The same applies to spare parts and accessories.

F Responsabilité

Nous vous signalons expressément que GARDENA n'est pas responsable des dommages causés par ses appareils, dans la mesure où ces dommages seraient causés suite à une réparation non conforme, dans la mesure où, lors d'un échange de pièces, les pièces d'origine GARDENA n'auraient pas été utilisées, ou si la réparation n'a pas été effectuée par le Service Après-Vente GARDENA ou l'un des Centres SAV agréés GARDENA. Ceci est également valable pour tout ajout de pièces et d'accessoires autres que ceux préconisés par GARDENA.

NL Productaansprakelijkheid

Wij wijzen er nadrukkelijk op, dat wij op grond van de wet aansprakelijkheid voor producten niet aansprakelijk zijn voor schade ontstaan door onze apparaten, indien deze door onvakkundige reparatie veroorzaakt zijn, of er bij het uitwisselen van onderdelen geen gebruik gemaakt werd van onze originele GARDENA onderdelen of door ons vrigegeven onderdelen en de reparatie niet door de GARDENA technische dienst of de bevoegde vakman uitgevoerd werd. Ditzelfde geldt voor extra-onderdelen en accessoires.

S Produktansvar

Tillverkaren är inte ansvarig för skada som orsakats av produkten om skadan beror på att produkten har reparats felaktigt eller om, vid reparation eller utbyte, andra än Original GARDENA reservdelar har använts. Samma sak gäller för kompletteringsdelar och tillbehör.

DK Produktansvar

Vi gør udtrykkeligt opmærksom på at i henhold til produktansvarsloven er vi ikke ansvarlige for skader forårsaget af vores udstyr, hvis det skyldes uautoriserede reparationer eller hvis dele er skiftet ud og der ikke er anvendt originale GARDENA dele eller dele godkendt af os, eller hvis reparationerne ikke er udført af GARDENA-service eller en autoriseret fagmand. Det samme gælder for ekstra udstyr og tilbehør.

FIN Tuotevastuu

Korostamme nimenomaan, että tuotevastuulain nojalla emme ole vastuussa laitteistamme johtuneista vahingoista, mikäli nämä ovat aiheutuneet epäasianmukaisesta korjauksesta tai osia vaihdettaessa ei ole käytetty alkuperäisiä GARDENA- varaosia tai hyväksymiämme osia ja korjauksen on suorittanut muu kuin GARDENA -huoltokeskus tai valtuuttamamme ammattihenkilö. Tämä pätee myös lisäosiin ja lisävarusteisiin.

I Responsabilità del prodotto

Si rende espressamente noto che, conformemente alla legislazione sulla responsabilità del prodotto, non si risponde di danni causati da nostri articoli se originati da riparazioni eseguite non correttamente o da sostituzioni di parti effettuate con materiale non originale GARDENA o comunque da noi non approvato e, in ogni caso, qualora l'intervento non venga eseguito da un centro assistenza GARDENA o da personale specializzato autorizzato. Lo stesso vale per le parti complementari e gli accessori.

E Responsabilidad de productos

Advertimos que conforme a la ley de responsabilidad de productos no nos responsabilizamos de daños causados por nuestros aparatos, siempre y cuando dichos daños hayan sido originados por arreglos o reparaciones indebidas, por recambios con piezas que no sean piezas originales GARDENA o bien piezas autorizadas por nosotros, así como en aquellos casos en que la reparación no haya sido efectuada por un Servicio Técnico GARDENA o por un técnico autorizado. Lo mismo es aplicable para las piezas complementarias y accesorios.

P Responsabilidade sobre o produto

Queremos salientear que segundo a lei da responsabilidade do fabricante, nós não nos responsabilizaremos por danos causados pelo nosso equipamento, quando estes ocorrerem em decorrência de reparações inadequadas ou da substituição de peças por peças não originais da GARDENA, ou peças não autorizadas. A responsabilidade tornar-se-à nula também depois de reparações realizadas por oficinas não autorizadas pela GARDENA. Esta restrição valerá também para peças adicionais e acessórios.

<p>D EG-Konformittserklring</p> <p>Der Unterzeichnete Husqvarna AB, 561 82 Huskvarna, Sweden besttigt, dass die nachfolgend bezeichneten Gerte in der von uns in Verkehr gebrachten Ausfhrung die Anforderungen der harmonisierten EU-Richtlinien, EU-Sicherheitsstandards und produktspezifischen Standards erfullen. Bei einer nicht mit uns abgestimmten nderung der Gerte verliert diese Erklrung ihre Gltigkeit.</p>	<p>H EU azonossgi nyilatkozat</p> <p>Alulirott, Husqvarna AB, 561 82 Huskvarna, Sweden, igazolja, hogy az albb felsorolt, ltalunk forgalomba hozott termkek megfelelnek az EU elvrsoknak, EU biztonsgi normknak s a termkspecifikus szabvnyoknak egyarnt. A kszlk velnk nem egyeztetett vltoztatsa esetn ez a nyilatkozat rvnyt veszti.</p>
<p>GB EU Declaration of Conformity</p> <p>The undersigned Husqvarna AB, 561 82 Huskvarna, Sweden, hereby certifies that, when leaving our factory, the units indicated below are in accordance with the harmonised EU guidelines, EU standards of safety and product specific standards. This certificate becomes void if the units are modified without our approval.</p>	<p>CZ ES Prohlšení o shod</p> <p>Nie podepsan spolenost Husqvarna AB, 561 82 Huskvarna, Sweden, potvrzuje, e nie oznaeny pstroj v proveden, ktery jsme uvedli na trh, spluje poadavky uveden v harmonizovanch smrnicih EU, v bezpenostnch standardech EU a ve standardech pro dan produkt. V prpad zmny pstroje, kter nmi nebyla odsouhlasena, ztrc toto prohlšení platnost.</p>
<p>F Certificat de conformit aux directives europennes</p> <p>Le constructeur, soussign : Husqvarna AB, 561 82 Huskvarna, Sweden, dclare qu' la sortie de ses usines le matriel neuf design ci-dessous tat conforme aux prescriptions des directives europennes nonces ci-aprs et conforme aux rgles de scurit et autres rgles qui lui sont applicables dans le cadre de l'Union europenne. Toute modification porte sur ce produit sans l'accord express de Husqvarna supprime la validit de ce certificat.</p>	<p>SK ES Vyhlasenie o zhode</p> <p>Dolu podpisan spolonost Husqvarna AB, 561 82 Huskvarna, Sweden, potvrdzuje, e dalej oznaeny prstroj vo vyhotoven nami uvedenom do prevdzky spla poadavky harmonizovanch smernic EU, bezpenostnch standardov EU a standardov specifickch pre produkt. V prpad zmeny prstroja, ktor nebola nami odsuhlasen, strca toto vyhlsenie platnos.</p>
<p>NL EU-overeenstemmingsverklaring</p> <p>Ondergetekende Husqvarna AB, 561 82 Huskvarna, Sweden, bevestigt, dat het volgende genoemde apparaat in de door ons in de handel gebrachte uitvoering voldoet aan de eis van, en in overeenstemming is met de EU-richtlijnen, de EU-veiligheidsstandaard en de voor het product specifieke standaard. Bij een niet met ons afgestemde verandering aan het apparaat verliest deze verklaring haar geldigheid.</p>	<p>GR Πιστοποιητικό συμφωνίας ΕΚ</p> <p>Η υπογεγραμμένη : Husqvarna AB, 561 82 Huskvarna, Sweden πιστοποιεί ότι τα μηχανήματα που υποδεικνύονται κάτωθι, όταν φεύγουν από το εργοστάσιο, είναι κατασκευασμένα σύμφωνα με τις οδηγίες της Ευρωπαϊκής Κοινότητας, τα Κοινωνικά πρότυπα ασφαλείας και τις προδιαγραφές. Αυτό το πιστοποιητικό δεν ισχύει σε περίπτωση που τα προϊόντα τροποποιηθούν χωρίς την έγκρισή μας.</p>
<p>S EU Tillverkarintyg</p> <p>Undertecknad firma Husqvarna AB, 561 82 Huskvarna, Sweden, intygar hrmed att nedan nmnda produkter overensstmmar med EU:s direktiv, EU:s skerhetsstandard och produktspecifikation. Detta intyg upphr att glla om produkten ndras utan vrt tillstnd.</p>	<p>SLO Izjava o skladnosti s pravili EU</p> <p>Podpisano podjetje, Husqvarna AB, 561 82 Huskvarna, Sweden, potrjuje, da v nadaljevanju navedena naprava v razlici, ki smo jo poslali na trg, izpolnjuje zahteve smernic EU, varnostnih standardov EU in standardov tovornih proizvodov. Izjava ne velja za spremembe na napravi, ki niso opravljene v soglasju z nami.</p>
<p>DK EU Overensstemmelse certificat</p> <p>Undertegnede Husqvarna AB, 561 82 Huskvarna, Sweden bekrfter hermed, at enheder listet herunder, ved afsendelse fra fabrikken, er i overensstemmelse med harmoniserede EU retningslinier, EU sikkerhedsstandarder og produkt-specifikationsstandarder. Dette certificat trder ud af kraft hvis enhederne er ndret uden vor godkendelse.</p>	<p>RO UE - Certificat de conformitate</p> <p>Prin prezenta Husqvarna AB, 561 82 Huskvarna, Sweden, certifica faptul ca, in momentul in care produsele mentionate mai jos ies din fabrica sunt in concordanta cu directivele UE, standardele de siguranta UE si standardele specifice ale produsului UE. Acest certificat devine nul in cazul modificarii aparatului fara aprobarea noastra.</p>
<p>FIN EY-vaatimustenmukaisuusvakuutus</p> <p>Allerkirjoittanut Husqvarna AB, 561 82 Huskvarna, Sweden vakuuttaa, ett allamainittu laitteet tyttvt tehtaatamme lhtessan yhdenmukaistettujen EY-direktiivien, EY-turvallisuusstandardien ja tuotekohtaisten standardien vaatimukset. Laitteisiin tehty muutokset, joista ei ole sovittu kanssamme, johtavat tmn vakuutuksen raukaamiseen.</p>	<p>BG ES-Декларация за съответствие</p> <p>Подписаната фирма Husqvarna AB, 561 82 Huskvarna, Sweden декларира, че описаните подолу уреди, пуasnати в продажба съгласно нашата спецификация, изпълняват изискванията на хармонизираните ЕС-директиви, ЕС-станданти за безопасност и специфичните производствени стандарти. При промяна на уреда, която не е съгласувана с нас, тази декларация губи своята валидност.</p>
<p>I Dichiarazione di conformit alle norme UE</p> <p>La sottoscritta Husqvarna AB, 561 82 Huskvarna, Sweden, certifica che il prodotto qui di seguito indicato, nei modelli da noi commercializzati,  conforme alle direttive armonizzate UE nonch agli standard di sicurezza e agli standard specifici di prodotto. Qualunque modifica apportata al prodotto senza nostra specifica autorizzazione invalida la presente dichiarazione.</p>	<p>EST Eli vastavusdeklaratsioon</p> <p>Allakirjutanu Husqvarna AB, 561 82 Huskvarna, Sweden kinnitab, et kirjeldatud seade vastab meie poolt ringluse viidud kujul Eli harmoniseeritud direktiividele, ELI ohutusstandarditele ja tootega seotud standarditele. Meiega koosklastamata muudatuse tegemise korral seadmel kaotab see deklaratsioon kehtivuse.</p>
<p>E Declaracin de conformidad de la UE</p> <p>El que suscribe Husqvarna AB, 561 82 Huskvarna, Sweden, declara que la presente mercanca, objeto de la presente declaracin, cumple con todas las normas de la UE, en lo que a normas tcnicas, de homologacin y de seguridad se refiere. En caso de realizar cualquier modificacin en la presente mercanca sin nuestra previa autorizacin, esta declaracin pierde su validez.</p>	<p>LT ES Atitikties deklaracija</p> <p>Pasirašanti Husqvarna AB, 561 82 Huskvarna, Sweden patvirtina, kad žemiau nurodyti prietaisai ir jų modeliai, kuriuos paleidome į apyvartą, patenkinia harmonizuotas ES direktyvas, ES saugumo standartus ir specifinius gaminio standartus. Atlikus bet kokį prietaiso pakeitimą, kuris nėra suderintas su mumis, ši deklaracija praranda galiojimą.</p>
<p>P Certificado de conformidade da UE</p> <p>Os abaixo mencionados Husqvarna AB, 561 82 Huskvarna, Sweden, por este meio certificam que ao sair da fbrica o aparelho abaixo mencionado est de acordo com as diretrizes harmonizadas da UE, padres de segurana e de produtos especficos. Este certificado ficar nulo se a unidade for modificada sem a nossa aprovao.</p>	<p>LV ES-atbilstības deklarācija</p> <p>Parakstījusies Husqvarna AB, 561 82 Huskvarna, Sweden, Vācija apstiprina, ka sekojoši apzīmētās iekārtas, kuras mēs izplatām, savā izpildījumā atbilst harmonizētājām ES direktīvām, ES drošības standartiem un produkta specifiskajiem standartiem. Ar mūsu neapstiprinātām izmaiņām iekārtā šī deklarācija zaudē savu derīgumu.</p>
<p>PL Deklaracja zgodności Unii Europejskiej</p> <p>Niżej podpisany Husqvarna AB, 561 82 Huskvarna, Sweden, potwierdza, że poniżej opisane urządzenie w wykonaniu wprowadzonym przez nas do obrotu spełnia wymogi zharmonizowanych wytycznych Unii Europejskiej, standardów bezpieczeństwa Unii Europejskiej i standardów specyficznych dla danego produktu. W przypadku wprowadzenia zmian nie uzgodnionych z nami wyjaśnienie to traci swoją ważność.</p>	

<p>Bezeichnung des Gerätes: Elektro-Heckenschere Description of the unit: Electric Hedge Trimmer Désignation du matériel : Taille-haies électrique Omschrijving van het apparaat: Elektrische heggenschaar Produktbeskrivning: Elektrisk Häcksax Kerätyöseläyksen kuvaus: Elektrisk hækkeklipper Laitteiden nimitys: Sähkökäyttöinen aitaileikkuri Descrizione del prodotto: Tagliasiepi elettrica Descripción de la mercancía: Recortasetos eléctrico Descrição do aparelho: Tesoura eléctrica de sebes Opis urządzenia: Elektryczne nożyce do żywoplotu</p> <p>A készlék megnevezése: Elektromos sövénynyíró Označení přístroje: Elektrické nůžky na živý plot Označení přístroja: Elektrické nožnice na živý plot Ονομασία της συσκευής: Ηλεκτρικό μηχανοσυρφόλλιο Oznaka naprave: Električne škarje za živo mejo Descrierea articolului: Trimmer-ul electric de tuns garduri vii</p> <p>Обозначение на уредите: Электрически хросторез за жив плет</p> <p>Seadmete nimetus: Elektrilised hekkikäärid Gaminio pavadinimas: Elektrinės gyvatvorių žirkklės Iekārtu apzīmējums: Elektriskais dzīvzogu trimmeris</p>	<p>Schall-Leistungspegel: gemessen / garantiert Noise level: measured / guaranteed Puissance acoustique : mesurée / garantie Geluidsniveau: gemeten / gegarandeerd Ljudnivá: uppmått / garanterad Lydytriksnivau: afmålt / garanti Melun tehotaso: mitattu / taattu Livello rumorosità: testato / garantito Nível sonoro: medido / garantizado Nível de ruído: medido / garantizado Poziom hałasu: zmierzony / gwarantowany Zajszint: mért / garantált Hladina hluku: naměřeno / zaručeno Υπόκονová úroveň hluku: meraná / zaručená Στάθμη ηχητικής πίεσης: μετρηθείσα / εγγυημένη Glasnost: izmerjeno / garantirano Nivelul de zgomot: măsurat / garantat Ниво на шума и мощността: измерено / гарантирано Helivõimsuse tase: mõõdetud / tagatud Garso galios lygis: išmatuotas / garantuotas Skaņas jaudas līmenis: izmērītais / garantētais</p> <p>95 dB (A) / 99 dB (A)</p>
<p>Typ: Τίpusok: Art.-Nr.: Cikkszám: Type: Typ: Art. No.: Č.výr: Type : Typ: Référence : Č.výr: Typ: Τύπος: Art. nr.: Κωδ. No.: Typ: Tip: Art.nr.: Št. art.: Type: Tipuri: Varenr. : Nr art.: Typit: Tipove: Art.-n:o.: Apt.-№: Modello: Tüübid: Art. : Toole nr.: Tipo: Tipas: Art. №: Gaminio Nr.: Tipo: Tipi: Art. №: Art.-Nr.: Typ: Nr art.:</p> <p>EasyCut 48 PLUS 8874</p>	<p>Anbringningsjahr der CE-Kennzeichnung: CE bejegyzés kelte: Year of CE marking: Rok prideleni značky CE: Date d'apposition du marquage CE : Rok pridelenia označenia CE: Installatiejaar van de CE-aanduiding: Έτος πιστοποίησης ποιότητας CE: CE-Märkningsår: Leto namestitve oznake CE: CE-Mærkningsår: Anul de marcarea CE: CE-merkin kiinnitysvuosi: Година на поставяне на CE-маркировка: Anno di rilascio della certificazione CE: CE-маркējuma uzlikšanas gads: Colocación del distintivo CE: Metai, kuriais paženklinta CE-ženku: Año de marcação pela CE: 2012 Rok nadania znaku CE:</p>
<p>EU-Richtlinien: EU szabványok: EU directives: Směrnice EU: Directives européennes : Smernice EU: EU-richtlijnen: Προδιαγραφές EK: EU direktiv : Smernice EU: EU Retningslinier : Directive UE: EY-direktiivit: EC-директиви: Direttive UE: ELI direktiivid: Normativa UE: ES direktivos: Directrices da UE: ES-direktivas: Dyrektywy UE:</p> <p>98/37/EC 2006/95/EC 2006/42/EC 2000/14/EC 2004/108/EC 2011/65/EC</p>	<p>Ulm, den 28.10.2012 Ulm, 28.10.2012 Fait à Ulm, le 28.10.2012 Ulm, 28-10-2012 Ulm, 2012.10.28. Ulm, 28.10.2012 Ulmissa, 28.10.2012 Ulm, 28.10.2012 Ulm, 28.10.2012 Ulm, 28.10.2012 Ulm, 28.10.2012r. Ulm, 28.10.2012 V Ulmu, dne 28.10.2012 Ulm, 28.10.2012 Ulm, 28.10.2012 Ulm, 28.10.2012 Ulm, 28.10.2012 Ulm, 2012.10.28 Ulm, 28.10.2012 Ulma, 28.10.2012</p> <p>Der Bevollmächtigte Authorised representative Représentant légal Gemachtigde Behörig Firmatecknare Teknisk direktör Valtuutettu edustaja Rappresentante autorizzato Representante autorizado Representante autorizado Upravniyony do reprezentaciji Meghatalmazott Zplnomocnenec Spilnomocnenec Νόμιμος εκπρόσωπος της εταιρίας Vodja tehničnega oddelka Conducerea tehnică Упълномощен Valitatud esindaja Įgaliotasis atstovas Pilnvarotā persona</p> <p> Peter Lameli Vice President</p>
<p>Harmonisierte EN: EN 60745-1 DIN EN ISO 12100 EN 60745-2-15</p>	<p>Hinterlegte Dokumentation: GARDENA Technische Dokumentation E. Renn 89079 Ulm Deposited Documentation: GARDENA Technical Documentation E. Renn 89079 Ulm Documentation déposée : Documentation technique GARDENA E. Renn 89079 Ulm Konformitätsbewertungsverfahren: Nach 2000/14/EG Art. 14 Anhang V Conformity Assessment Procedure: according to 2000/14/EC Art. 14 Annex V Procédure d'évaluation de la conformité : Selon 2000/14/CE art. 14 Annexe V</p>

