

9V Art. 1251

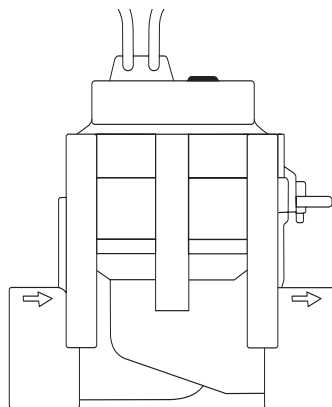

24V Art. 1278

- D Betriebsanleitung**
Bewässerungsventil
-
- GB Operating Instructions**
Irrigation Valve
-
- F Mode d'emploi**
Electrovanne
-
- NL Instructies voor gebruik**
Beregeningsventiel
-
- S Bruksanvisning**
Ventil
-
- I Istruzioni per l'uso**
Valvola cordless
-
- E Manual de instrucciones**
Válvula de riego
-
- P Instruções de utilização**
Válvula de Irrigação
-
- DK Brugsanvisning**
Vandingsventil

GARDENA Irrigation Valve

Welcome to the Garden of GARDENA...



Translation of the original instructions from German. Please read these operating instructions carefully and observe the notes given. Use these operating instructions to familiarise yourself with the Irrigation Valve, its correct use and the notes on safety.



For safety reasons, children under 16 as well as persons not familiar with these operating instructions should not use this Irrigation Valve.

→ Please keep these operating instructions in a safe place.

Contents

1. Where to Use Your GARDENA Irrigation Valve	8
2. Safety instructions	9
3. Initial Operation	9
4. Operation	10
5. Trouble-Shooting	11
6. Protection against Frost	11
7. Technical Data	12
8. Service / Warranty	12

1. Where to Use Your GARDENA Irrigation Valve

Intended use

The Irrigation Valves are intended solely for outdoor use for fully automatic control of individual irrigation systems. It is a benefit to arrange a watering system into separate sections in case of varying watering needs for different plant areas or if there is insufficient water available for simultaneous operation of the entire watering system.

The Irrigation Valve is installed upstream in the watering system (e.g. Pop-up Sprinklers; Micro-Drip-System), for example, in the ground.

Please note

Compliance with the enclosed operating instructions provided by GARDENA is a prerequisite for proper use of the Irrigation Valve.

9V:

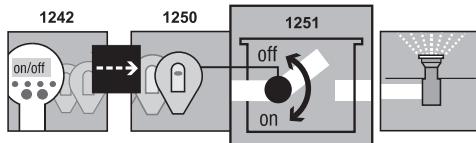

9V:

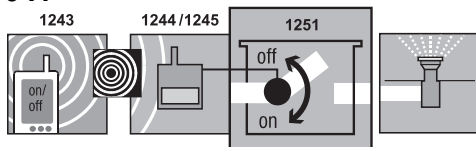

24 V:

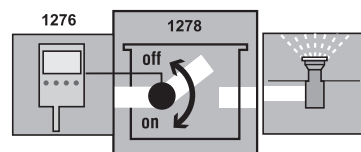

The Irrigation Valve **1251** forms part of an irrigation system in conjunction with the Programming Unit **1242** and the Control Unit **1250** or the Central Radio Control Unit **1243** and a Radio Receiver **1244/1245**.

The Irrigation Valve **1278** forms part of an irrigation system in conjunction with the Watering Controller **1276**.



The Irrigation Valve must only be used in conjunction with the – 9 V Control Units; Radio Receivers / 24 V Watering Controller – approved by GARDENA.

2. Safety instructions

Blocking the Irrigation Valve

Water pressure

→ Please observe the notes on safety in the operating instructions.

9 V and 24 V products are not interchangeable.

→ **In the case of dirty water, the GARDENA Central Filter Art. No. 1506 / 1510 must be installed upstream in the watering system.**

The function of your watering system depends on the available water pressure. Therefore, care should be taken not to overlap watering cycles of the various watering circuits and to ensure that the watering circuits you have planned will be supplied with sufficient water at an adequate pressure.

Please refer to the planning instructions in the special brochure entitled “Watering Systems – Sprinkler System Planning Guide” available from GARDENA.

3. Initial Operation

If the Irrigation Valve is installed below ground level, it must be installed in a sturdy and step-proof valve mount ① (valve box) e.g. GARDENA Art. No. 1254 / 1255 / 1290 / 1292.

Install the valve mount:

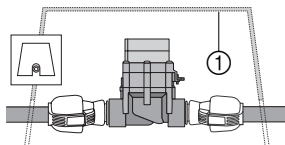
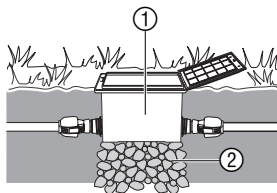

1. Draw up a plan (an example is shown in the figure below).

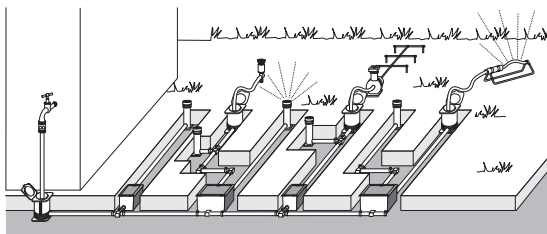

Additional information is provided in the GARDENA Sprinkler System Planning Guide which is available from your GARDENA dealer.

2. For underground installation, place a layer of coarse gravel ② underneath the valve mount ①. This ensures proper drainage of the box.
3. Install the valve box with the top edge of the box at ground level. This avoids damage when mowing the lawn.

Please refer to the relevant operating instructions for information on how to install the Irrigation Valves in GARDENA Valve Boxes V1 and V3.

Installing the Irrigation Valve without a Valve Box:

The integrated solenoid valve works only correctly with the Irrigation Valve connected in flow direction.



Flow direction

→ Pay attention to the flow direction (arrows) when installing the Irrigation Valve ③.

→ Seal the screw connections with Teflon band, **Art. 7219**.

Connection to GARDENA Connecting Pipes ⑤ (1580/1582):

1. Push a Hose Clip **1591** ④ over the two pipe ends ⑤.
2. Screw a Connection Piece **1518** ⑥ into both the inlet-side and the outlet-side of the Irrigation Valve ③.
3. Push both pipe ends ⑤ onto the Tap Connectors ⑥ and secure with the Hose Clips ④.

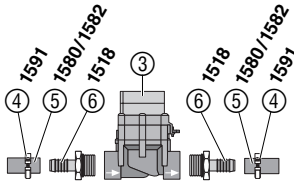

Connecting GARDENA Connecting pipes ⑧ (2700/2701/2704/2705) or other commercially available connecting pipes:

1. Screw a **GARDENA Connector ⑦ 2763** (1" = 25 mm) / **2769** (5/4" = 32 mm) into the Irrigation Valve ③.
2. Connect the GARDENA connecting pipes ⑧ or other commercially available connecting pipes (25 mm / 32 mm).

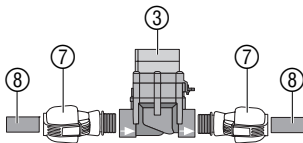

Connect Soil Moisture Sensor or Rain Sensor electronic (optional):

In conjunction with the programmed watering time, the moisture level of the soil or the natural precipitation can be taken into account for each Irrigation Valve.

When a sufficient moisture content of the soil is reached, a programme may be interrupted or activation of a programme may be suppressed.

1. Place the Soil Moisture Sensor ⑨ in the area to be irrigated – or – the Rain Sensor electronic (if necessary with an extension cable) **outside** of the area to be irrigated.
2. **9V:** Plug the connector ⑩ into the sensor socket of the Control Unit / Radio Receiver.
24V: Insert plug ⑩ in the sensor connection of the Watering Control System **Art. 1276** (s. Operating Instructions **Art. 1276**).

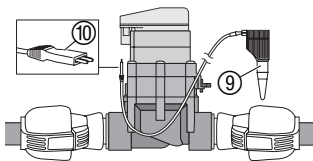

Conventional installation:

If using **Art. 2750/2751/2752/2753/2755** the points marked with an arrow must be sealed with Teflon tape (e.g. **Art. No. 7219**).

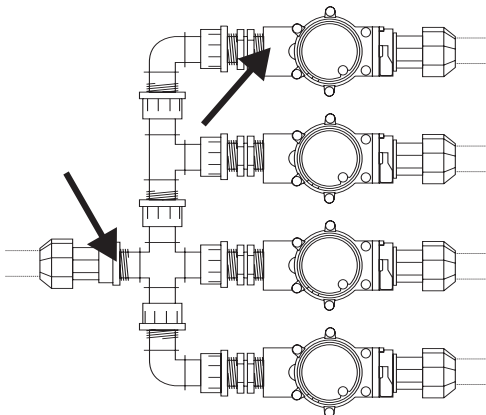

4. Operation

Adjusting valve control:

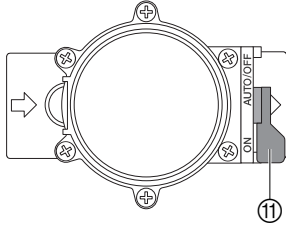

Fully Automatic Control:

→ Set selection lever ⑪ to “**AUTO/OFF**”.

Programme-controlled water flow to the watering system according to the programming in the Control Unit / Radio Receiver.

An automatically opened valve cannot be closed manually.

Manual Control:

→ Set selection lever ⑪ to “**ON**”.

Permanent water flow, independent of the programming.

5. Trouble-Shooting

Fault	Possible Causes	Remedy
Solenoid valve does not open, no water flow	No water supply. Control Unit / Radio Receiver / Watering Controller not connected correctly to Irrigation Valve.	→ Turn on water supply. → Connect Control Unit / Radio Receiver / Watering Controller correctly to Irrigation Valve.
Solenoid valve does not close, continuous water flow	Solenoid valve installed opposite to flow direction. Selection lever ⑪ set to “ ON ”.	→ Turn solenoid valve (observe the flow direction). → Set selection lever ⑪ to “ AUTO/OFF ”.

If other faults occur, please contact GARDENA Customer Service.

6. Protection against Frost

Winter storage:

GARDENA Irrigation Valves are intended for outdoor use and are only frost-proof to a limited extent. The only way to protect your Irrigation Valves completely is to remove the valves before the frosty season begins. Alternatively, you can drain the pipeline system upstream and downstream of the Irrigation Valve.

Emptying the pipeline system UPSTREAM of the valve:

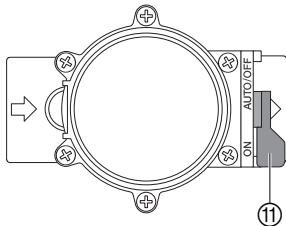

1. Turn off the tap and disconnect the hose between the tap and the **GARDENA Water Connection Point Art. No. 1594 / Art. No. 2795**.
This allows the air to flow freely and the supply line can be drained using the drain valve integrated in the Connecting Point. This requires that the Connecting Point be installed deeper in the ground than the Irrigation Valve.
2. If the watering system is directly connected to the water tap, turn off the water supply and open the venting tap.
3. Set the selection lever ⑪ of all valves to the “**ON**” position.
4. If you are using the GARDENA Valve Box V3, make sure you open the integrated drain cap.

Emptying the pipeline system DOWNSTREAM of the valve:

Requirement: The Drainage Valve must be installed deeper than or at the same depth as the Irrigation Valve.

→ Install a GARDENA Drainage Valve **Art. No. 2760** immediately after the valve.

The system is drained automatically via the the GARDENA Drainage Valve.

→ **If neither of these requirements is fulfilled, the valve must be removed and stored in a place safe from frost.**

Disposal:

(in accordance with
RL2002/96/EC)



Product must not be added to normal household refuse but must be disposed of properly.

7. Technical Data

Solenoid Valve	9V (Art. No. 1251)	24V (Art. No. 1278)
Voltage	9V DC	24V AC
Operating pressure	0.5 to 12 bar	0.5 to 12 bar
Flow medium	clean fresh water	clean fresh water
Max. water temperature	40 °C	40 °C

8. Service / Warranty

GARDENA guarantees this product for 2 years (from date of purchase). This guarantee covers all serious defects of the unit that can be proved to be material or manufacturing faults. Under warranty we will either replace the unit or repair it free of charge if the following conditions apply:

- The unit must have been handled properly and in keeping with the requirements of the operating instructions.
- Neither the purchaser or a non-authorized third party have attempted to repair the unit.

Faults with the Irrigation Valve caused by incorrectly installed batteries or leaking batteries in the Control Unit / Radio Receiver are not covered by the guarantee.

This manufacturer's guarantee does not affect the user's existing warranty claims against the dealer/seller.

If a fault occurs with your Irrigation Valve, please return the faulty unit together with a copy of the receipt and a description of the fault, with postage paid to one of the GARDENA Service Centres listed on the back of these operating instructions.

<p>D <i>Produkthftung</i></p>	<p>Wir weisen ausdrücklich darauf hin, dass wir nach dem Produkthaftungsgesetz nicht für durch unsere Geräte hervorgerufene Schäden einzustehen haben, sofern diese durch unsachgemäße Reparatur verursacht oder bei einem Teileaustausch nicht unsere Original GARDENA Teile oder von uns freigegebene Teile verwendet werden und die Reparatur nicht vom GARDENA Service oder dem autorisierten Fachmann durchgeführt wird. Entsprechendes gilt für Ergänzungssteile und Zubehör.</p>
<p>GB <i>Product Liability</i></p>	<p>We expressly point out that, in accordance with the product liability law, we are not liable for any damage caused by our units if it is due to improper repair or if parts exchanged are not original GARDENA parts or parts approved by us, and, if the repairs were not carried out by a GARDENA Service Centre or an authorised specialist. The same applies to spare parts and accessories.</p>
<p>F <i>Responsabilité</i></p>	<p>Nous vous signalons expressément que GARDENA n'est pas responsable des dommages causés par ses appareils, dans la mesure où ces dommages seraient causés suite à une réparation non conforme, dans la mesure où, lors d'un échange de pièces, les pièces d'origine GARDENA n'auraient pas été utilisées, ou si la réparation n'a pas été effectuée par le Service Après-Vente GARDENA ou l'un des Centres SAV agréés GARDENA. Ceci est également valable pour tout ajout de pièces et d'accessoires autres que ceux préconisés par GARDENA.</p>
<p>NL <i>Productaansprakelijkheid</i></p>	<p>Wij wijzen er nadrukkelijk op, dat wij op grond van de wet aansprakelijkheid voor producten niet aansprakelijk zijn voor schade ontstaan door onze apparaten, indien deze door onvakkundige reparatie veroorzaakt zijn, of er bij het uitwisselen van onderdelen geen gebruik gemaakt werd van onze originele GARDENA onderdelen of door ons vrijgegeven onderdelen en de reparatie niet door de GARDENA technische dienst of de bevoegde vakman uitgevoerd werd. Ditzelfde geldt voor extra-onderdelen en accessoires.</p>
<p>S <i>Produktansvar</i></p>	<p>Tillverkaren är inte ansvarig för skada som orsakats av produkten om skadan beror på att produkten har reparerats felaktigt eller om, vid reparation eller utbyte, andra än Original GARDENA reservdelar har använts. Samma sak gäller för kompletteringsdelar och tillbehör.</p>
<p>I <i>Responsabilità del prodotto</i></p>	<p>Si rende espressamente noto che, conformemente alla legislazione sulla responsabilità del prodotto, non si risponde di danni causati da nostri articoli se originati da riparazioni eseguite non correttamente o da sostituzioni di parti effettuate con materiale non originale GARDENA o comunque da noi non approvato e, in ogni caso, qualora l'intervento non venga eseguito da un centro assistenza GARDENA o da personale specializzato autorizzato. Lo stesso vale per le parti complementari e gli accessori.</p>
<p>E <i>Responsabilidad de productos</i></p>	<p>Advertimos que conforme a la ley de responsabilidad de productos no nos responsabilizamos de daños causados por nuestros aparatos, siempre y cuando dichos daños hayan sido originados por arreglos o reparaciones indebidas, por recambios con piezas que no sean piezas originales GARDENA o bien piezas autorizadas por nosotros, así como en aquellos casos en que la reparación no haya sido efectuada por un Servicio Técnico GARDENA o por un técnico autorizado. Lo mismo es aplicable para las piezas complementarias y accesorios.</p>
<p>P <i>Responsabilidade sobre o produto</i></p>	<p>Queremos salientar que segundo a lei da responsabilidade do fabricante, nós não nos responsabilizaremos por danos causados pelo nosso equipamento, quando estes ocorram em decorrência de reparações inadequadas ou da substituição de peças por peças não originais da GARDENA, ou peças não autorizadas. A responsabilidade tornar-se-à nula também depois de reparações realizadas por oficinas não autorizadas pela GARDENA. Esta restrição valerá também para peças adicionais e acessórios.</p>
<p>DK <i>Produktansvar</i></p>	<p>Vi gør udtrykkeligt opmærksom på at i henhold til produktansvarsloven er vi ikke ansvarlige for skader forårsaget af vores udstyr, hvis det skyldes uautoriserede reparationer eller hvis dele er skiftet ud og der ikke er anvendt originale GARDENA dele eller dele godkendt af os, eller hvis reparationerne ikke er udført af GARDENA-service eller en autoriseret fagmand. Det samme gælder for ekstra udstyr og tilbehør.</p>

Bild Nr. Picture No.	Ersatzteil-Nr. Spare Part No.	Bezeichnung Bewässerungsventil 9V/1" Art. - Nr. 1251	Description Watering Valve 9V/1" Art. No. 1251
19 - 36	1251-00.500.00	Bew. Ventil 9V/ 1" (=Art.1251)	Watering valve 9V/ 1" (=Art.1251)
19	1815-00.610.27	Steuerdüse, rot	Control nozzle, red
20	1251-00.500.26	Ventildeckel	Valve cover
21	913-00.680.01	O-Ring 7,5 x 2	O-Ring 7,5 x 2
22 + 21	1251-00.701.00	Kücken, vollst.	Mixer dial, cpl.
23	1672-00.600.11	O-Ring 24 x 2	O-Ring 24 x 2
24	1174-00.617.00	Magnetplatte, vollst.	Magnetic plate, cpl.
25	1174-00.610.11	Druckfeder, klein	Pressure spring, small
26	1251-00.510.00	Elektromagnet, vollst.	Electric magnet, cpl.
27	1174-00.610.07	Blechschraube 3,5 x 25-F-H	Sheet metal screw 3,5 x 25-F-H
28	1251-00.500.21	Blechschraube 4,2 x 60	Sheet metal screw 4,2 x 60 (6 x)
29	1174-00.610.08	Druckfeder, gross	Pressure spring, large
30 - 34	1251-00.520.00	Membrane, vollst.	Diaphragm
35	1251-00.500.11	Stützring	Support ring
36	1251-00.500.06	Ventilkörper	Valve body
	1251-00.540.00	Feinfilter	Fine filter

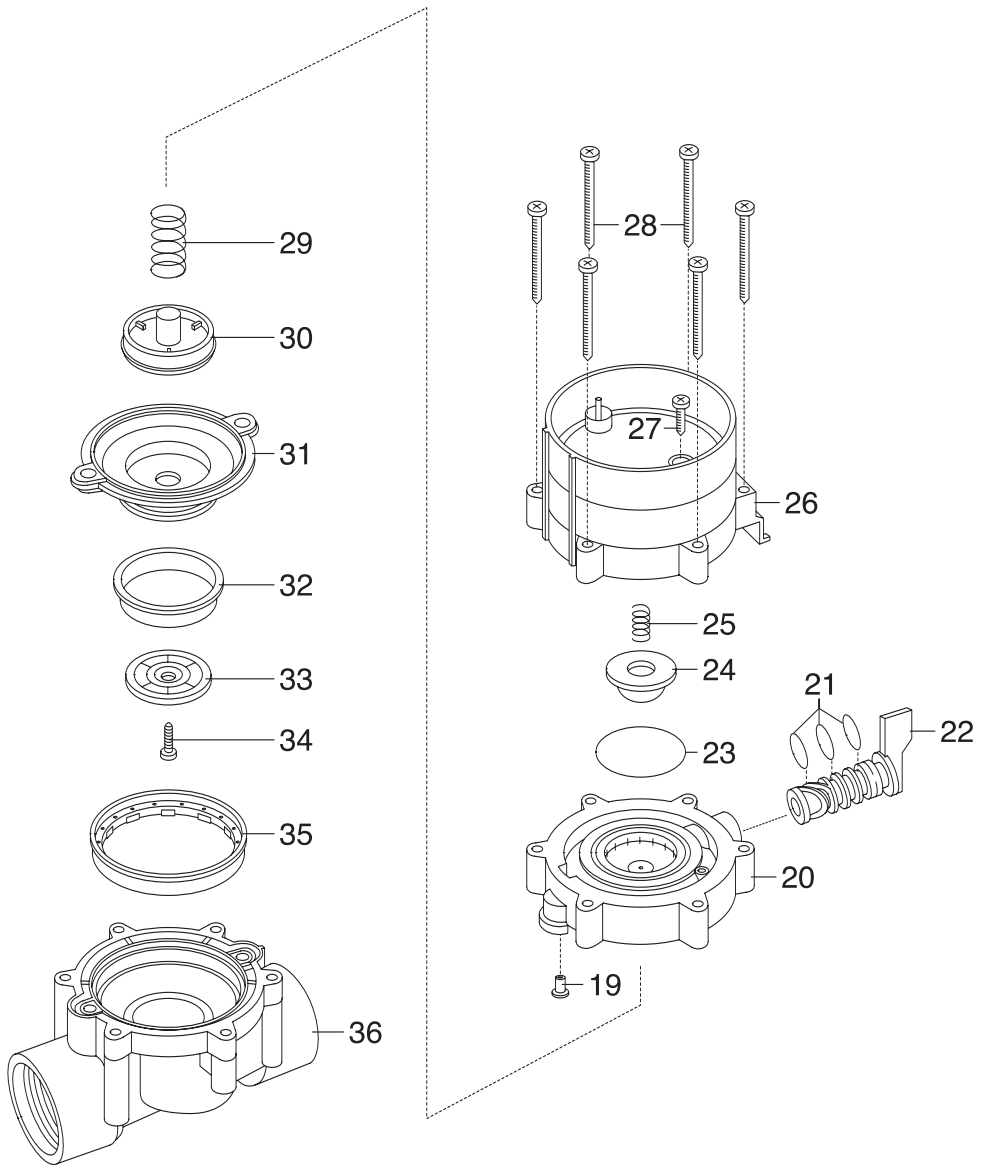

Deutschland / Germany

GARDENA
Manufacturing GmbH
Central Service
Hans-Lorenser-Straße 40
D-89079 Ulm
Produktfragen:
(+49) 731 490-123
Reparaturen:
(+49) 731 490-290
service@gardena.com

Argentina

Husqvarna Argentina S.A.
Vera 745
(C1414AOO) Buenos Aires
Phone: (+54) 11 4858-5000
diego.poggi@ar.husqvarna.com

Australia

Husqvarna Australia Pty. Ltd.
Locked Bag 5
Central Coast BC
NSW 2250
Phone: (+61) 1800 802831
customer.service@
husqvarna.com.au

Austria / Österreich

Husqvarna Austria GmbH
Consumer Products
Industriezeile 36
4010 Linz
Tel.: (+43) 732 77 01 01 - 90
consumer.service@husqvarna.at

Belgium

GARDENA Belgium NV/SA
Sterrebeekstraat 163
1930 Zaventem
Phone: (+32) 2 72092 12
Mail: info@gardena.be

Brazil

Palash Comércio e
Importação Ltda.
Rua São João do Araguaia, 338
- Jardim Califórnia -
Barueri - SP - Brasil -
CEP 06409-060
Phone: (+55) 11 4198-9777
eduardo@palash.com.br

Bulgaria

Хускварна България ЕООД
1799 София
Бул. „Андрей Ляпчев“ № 72
Тел.: (+359) 2 80 99 424
www.husqvarna.bg

Canada

GARDENA Canada Ltd.
100 Summerlea Road
Brampton, Ontario L6T 4X3
Phone: (+1) 905 792 9330
info@gardenacanada.com

Chile

Antonio Martinic y Cia Ltda.
Cassillas 272
Centro de Cassillas
Santiago de Chile
Phone: (+56) 2 20 10 708
garfar_cl@yahoo.com

Costa Rica

Compania Exim
Euroberoamericana S.A.
Los Colegios, Moravia,
200 metros al Sur del Colegio
Saint Francis - San José
Phone: (+506) 297 68 83
exim_euro@racsa.co.cr

Croatia

KLIS d.o.o.
Stanciceva 79
10419 Vukovina
Phone: (+385) 1 622 777 0
gardena@klis-trgovina.hr

Cyprus

FARMOKIPIKI LTD
P.O. Box 7098
74, Digeni Akritas Ave.
1641 Nicosia
Phone: (+357) 22 75 47 62
condam@spidernet.com.cy

Czech Republic

GARDENA spol. s r.o.
Tuřanka 115
627 00 Brno
Phone: (+420) 548 217 777
gardena@gardenabrn.cz

Denmark

GARDENA
Husqvarna Consumer Outdoor
Products
Salgsafdelning Danmark
Box 9003
S-200 39 Malmö
info@gardena.dk

Estonia

Husqvarna Eesti OÜ
Consumer Outdoor Products
Kesk tee 10, Aaviku küla
Rae vald, Harju maakond
75305
kontakt.etj@husqvarna.ee

Finland

Oy Husqvarna Ab
Consumer Outdoor Products
Lautatarhankatu 8 B / PL 3
00581 HELSINKI
info@gardena.fi

France

GARDENA France
Immeuble Expositel
9 - 11 allée des Pierres Mayettes
ZAC des Barbanniers, B.P. 99
- F - 92232 GENNEVILLIERS
cedex
Tél. (+33) 01 40 85 30 40
service.consommateurs@
gardena.fr

Great Britain

Husqvarna UK Ltd
Preston Road
Aycliffe Industrial Park
Newton Aycliffe
County Durham
DL5 6UP
info.gardena@
husqvarna.co.uk

Greece

HUSQVARNA GREECE S.A.
Branch of Koropi
Ilfestou 33A
Industrial Area Koropi
194 00 Athens - Greece
V.A.T. EL094094640
Phone: (+30) 210 66 20 225
info@husqvarna-consumer.gr

Hungary

Husqvarna
Magyarország Kft.
Ezred u. 1 - 3
1044 Budapest
Phone: (+36) 80 20 40 33
gardena@gardena.hu

Iceland

Ó. Johnson & Kaaber
Tunguhalsi 1
110 Reykjavik
ooj@ojk.is

Ireland

Michael McLoughlin & Sons
Hardware Limited
Long Mile Road
Dublin 12

Italy

GARDENA Italia S.p.A.
Via Donizetti 22
20020 Lainate (Mi)
Phone: (+39) 02.93.94.79.1
info@gardenaitalia.it

Japan

KAKUICHI Co. Ltd.
Sumitomo Realty &
Development Kojimachi
BLDG., 8F, 5-1 Nibanbanyo,
Chiyoda-ku, Tokyo 102-0084
Phone: (+81) 33 264 4721
m_ishihara@kaku-ichi.co.jp

Latvia

SIA „Husqvarna Latvija“
Consumer Outdoor Products
Bakūžu iela 6, Rīga, LV-1024
info@husqvarna.lv

Lithuania

UAB Husqvarna Lietuva
Consumer Outdoor Products
Atleities pl. 77C
LT-52104 Kaunas
centras@husqvarna.lt

Luxembourg

Magasins Jules Neuberg
39, rue Jacques Stas
Luxembourg-Gasperich 2549
Case Postale No. 12
Luxembourg 2010
Phone: (+352) 40 14 01
api@neuberg.lu

Netherlands

GARDENA Nederland B.V.
Postbus 50176
1305 AD ALMERE
Phone: (+31) 36 521 00 00
info@gardena.nl

Neth. Antilles

Jonka Enterprises N.V.
Sta. Rosa Weg 196
P.O. Box 8200, Curaçao
Phone: (+599) 9 767 66 55
pgm@jonka.com

New Zealand

Husqvarna New Zealand Ltd.
PO Box 76437
Manukau City 2241
Phone: (+64) 09 9202410

Norway

GARDENA
Husqvarna Consumer Outdoor
Products
Salgskontor Norge
Kleiverveien 6
1540 Vestby
info@gardena.no

Poland

Husqvarna Poland Spółka z o.o.
Oddział w Szymanowie
Szymanów 9 d
05-532 Baniocha
Phone: (+48) 22 727 56 90
gardena@gardena.pl

Portugal

GARDENA Portugal Lda.
Sintra Business Park
Edifício 1, Fracção 0-G
2710-089 Sintra
Phone: (+351) 21 922 85 30
info@gardena.pt

Romania

MADEX INTERNATIONAL SRL
Soseaua Odaii 117-123,
Sector 1,
București, RO 013603
Phone: (+40) 21 352 76 03
madex@ines.ro

Russia

ООО ГАРДЕНА PVC
123007, г. Москва
Хорошевское шоссе, д. 32А
Тел.: (+7) 495 380 31 92
info@gardena-rus.ru

Singapore

Hy - Ray PRIVATE LIMITED
40 Jalan Pemimpin
#02-08 Tat Ann Building
Singapore 577185
Phone: (+65) 6253 2277
shiyang@hyray.com.sg

Slovak Republic

GARDENA spol. s r.o.
Tuřanka 115
627 00 Brno
Phone: (+420) 548 217 777
gardena@gardenabrn.cz

Slovenia

GARDENA d.o.o.
Brodšiče 15
1236 Trzin
Phone: (+386) 1 580 93 32
servis@gardena.si

South Africa

GARDENA
South Africa (Pty.) Ltd.
P.O. Box 11534
Vorna Valley 1686
Phone: (+27) 11 315 02 23
sales@gardena.co.za

Spain

GARDENA IBÉRICA S.L.U.
C/ Basauri, nº 6
La Florida
28023 Madrid
Phone: (+34) 91 708 05 00
atencioncliente@gardena.es

Sweden

GARDENA
Husqvarna Consumer Outdoor
Products
Försäljningskontor Sverige
Box 9003
200 39 Malmö
info@gardena.se

Switzerland / Schweiz

GARDENA Schweiz AG
Consumer Products
Industriestrasse 10
5506 Mägenwil
Phone: (+41) (0) 848 800 464
info@gardena.ch

Turkey

GARDENA / Dost Diş Ticaret
Müessesilik A.Ş. Sanayi
Çad. Adil Sokak No. 1
Kartal - Istanbul
Phone: (+90) 216 38 93 939
info@gardena-dost.com.tr

Ukraine / Україна

ТОВ «ГАРДЕНА УКРАЇНА»
Васильківська, 34, 204-Г
03022, Київ
Тел. (+38 044) 498 39 02
info@gardena.ua

1251-20.960.12/1008
© GARDENA
Manufacturing GmbH
D-89070 Ulm
http://www.gardena.com