

THS 400 Art. 2586

- D** **Gebrauchsanweisung**
Teleskop-Heckenschere
-
- GB** **Operating Instructions**
Telescopic Hedge Trimmer
-
- F** **Mode d'emploi**
Taille-haies télescopique
-
- NL** **Gebruiksaanwijzing**
Telescoop-heggenschaar
-
- S** **Bruksanvisning**
Teleskopisk Häcksax
-
- I** **Istruzioni per l'uso**
Tagliasiepi telescopica
-
- E** **Manual de instrucciones**
Recortasetos telescópico
-
- P** **Instruções de utilização**
Tesoura telescópica de sebes
-
- CZ** **Návod k použití**
Teleskopické nůžky na živý plot
-
- SK** **Návod na použitie**
Teleskopické nožnice na živý plot

GARDENA Telescopic Hedge Trimmer THS 400

Welcome to the Garden of GARDENA...



Please read these operating instructions carefully and observe the notes given. Use these operating instructions to familiarise yourself with the hedge trimmer, its proper use and the notes on safety.



For safety reasons, children under the age of 16 and people not familiar with these operating instructions must not use this hedge trimmer.

→ Please keep these operating instructions in a safe place.

Contents

1. Where to Use Your GARDENA Hedge Trimmer	9
2. Safety instructions	9
3. Function	11
4. Assembly	11
5. Operation	11
6. Preparation for Storage	13
7. Maintenance	13
8. Troubleshooting	13
9. Technical Data	14
10. Warranty	14

1. Where to Use Your GARDENA Hedge Trimmer

Correct Use:

The GARDENA Hedge Trimmer is intended for cutting hedges in private domestic gardens and allotments.

Adherence to these operating instructions is a precondition for the correct use of the hedge trimmer.

Please note



WARNING! Risk of injury!

The hedge trimmer must not be used for cutting lawns / lawn edges or for chopping up material for composting purposes.

2. Safety Instructions

→ Please follow the safety instructions on the hedge trimmer.



WARNING!

→ Please read the operating instructions before this hedge trimmer.

Check each time you use the hedge trimmer:

Inspect the unit before each use. Do not use the hedge trimmer if safety devices (two-hand switch, blade stop, impact protection) and / or the blades are damaged or worn.



DANGER!

→ Do not use in rain or wet conditions.

Never bypass the safety devices.



DANGER!

→ Remove the plug from the mains socket if the cable is cut through or damaged.

Inspect the area to be cut before and during work. Remove any foreign objects.

If you should come across any obstructions when cutting, turn off the hedge trimmer and remove the obstruction.

Check blades regularly for damage and have them correctly repaired immediately if any damage is found.

The blade-stop system prevents the hedge trimmer kicking back if it strikes solid objects.

Keep the motor casing and ventilation area free from obstructions, leaves and other similar objects.

Operation:



DANGER! Risk of injury!

The hedge trimmer can cause serious injury!

Keep the guide-handle dry and free from oil and grease.

Concentrate and work with care. You are responsible for the safety of the working area. Keep the area of work tidy. Untidiness in the area of work can cause accidents.

Do not wear loose clothes, jewellery, etc as they could get caught in the trimmer. Wear non-slip shoes, gloves and eye protection. Wear long trousers to protect your legs.

Ensure you have a secure foothold during operation of the machine, especially when using steps.

Take extra care when walking backwards. You may stumble.

When work is interrupted:

Never leave the hedge trimmer unattended where you are working.

If you interrupt your work and go to another area of the garden, always switch off the hedge trimmer and disconnect the mains plug!

If the blades jam, release the start button immediately, disconnect the mains plug and remove the obstruction.

To prevent it starting accidentally, never carry the hedge trimmer by the start buttons.

Always put the blade guard on the hedge trimmer when carrying or storing the unit.

Environmental Influences:

Ensure that no other people (especially children) or animals are anywhere near the working area.

Only work when visibility is good.

Get to know your surroundings and be aware of possible dangers which you may not be able to hear because of the noise from the machine.

Electrical safety:



DANGER! Electric shock!

The Hedge Trimmer must not be operated with a damaged electrical cable.

If the mains or extension cable is damaged, disconnect the mains plug immediately.

The mains or extension cable should always be kept away from the cutting area.

Check the power cable regularly for damage and signs of wear and tear.

The power cable must only be replaced by an authorised electrician. Please contact your GARDENA Service Centre.

Only use permitted extension cables. If in doubt ask your electrician.

Never use the equipment when it is raining or in a damp or wet area.

Do not operate the hedge trimmer in or near swimming pools and garden ponds.

Do not use the hedge trimmer in the vicinity of flammable liquids and gases.

For portable units which are used outdoors, we recommend to use a residual-current device having a residual-current rating ≤ 30 mA.

In Switzerland use of a residual-current device is obligatory.

Never carry the hedge trimmer by its cable. Never use the cable to pull the mains plug out of the mains socket.

Protect the cable from heat, oil and sharp edges.

3. Function

**Working position
basic settings:**

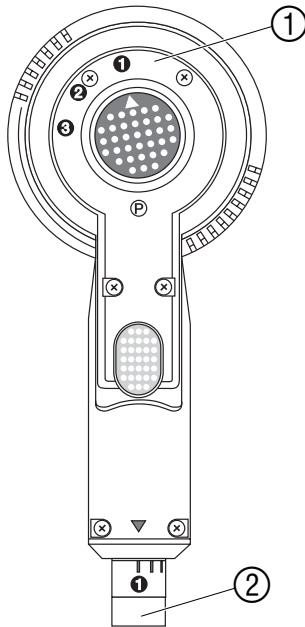

The Telescopic Hedge Trimmer has three basic settings, which are marked on the blade head ① and the handle ② as positions ①, ② and ③.

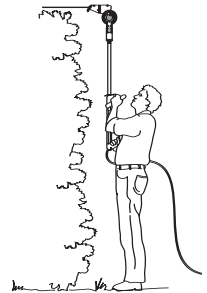
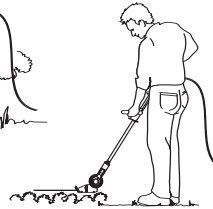
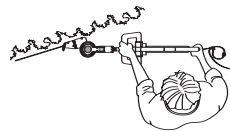
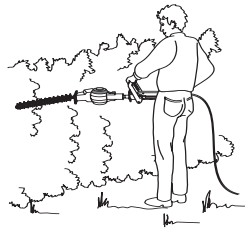

Side trimming (position ①) of hedges, at a distance from the standing position, (e.g. reaching over flower beds).

Low trimming (position ②) of low hedges (e.g. ground cover) while standing upright.

High trimming (position ③) of hedges up to approx. 2.5 m from the ground without using a ladder or scaffolding.

4. Assembly

Fitting the guide handle:

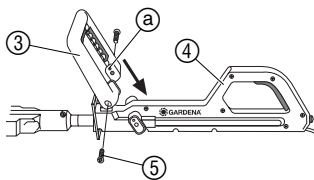

1. Push the guide handle ③ onto the main handle ④ in such a way, that the plunger (a) of the guide handle ③ is on the right side.
2. Secure the guide handle ③ to the main handle ④ with the two screws ⑤.

5. Operation

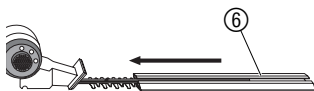

DANGER ! Risk of physical injury!

- Always disconnect the Hedge Trimmer from the power supply and slide the trimmer blade sheath ⑥ over the trimmer blade before making any adjustments.
- Never take hold of the trimmer blade when adjusting the working position!
- Always ensure that the angle button ⑧, the axial button ⑨ and the telescopic button ⑩ snap into place correctly.

Adjusting the Hedge Trimmer to the working position:

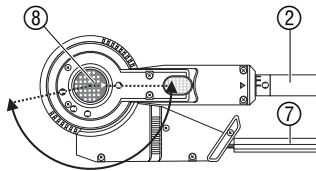

Adjusting the cutting angle of the trimmer blade ⑦ :

The cutting angle between the telescopic shaft ② and the trimmer blade ⑦ can be set to one of 8 positions in 12° steps from 0° ②, to 84° ①.

The 3 basic settings (see 3. Functions) can be set by moving the ► of the angle button ⑧ to position ①, ② or ③.

→ Keeping the angle button ⑧ pressed, turn the trimmer blade ⑦ to the desired cutting angle.

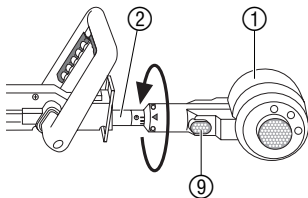

Adjusting the axial position of the trimmer blade head ① :

The trimmer blade head ① can be set to one of 7 positions in 30° steps from 0° to 180°. The 3 basic settings (see 3. Functions) can be set by moving the ► on the handle ② to position ①, ② or ③.

→ Keeping the axial button ⑨ pressed, turn the trimmer blade head ① to the desired axial position.

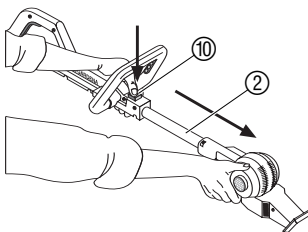

Adjusting the length of the telescopic handle ② :

The telescopic handle can be extended by up to 31 cm.

→ Keeping the telescopic button ⑩ pressed, move the telescopic handle ② to the desired length.

Connecting the Hedge Trimmer:

1. Loop the extension cable ⑪ and insert the loop into the cable lock ⑫.
2. Insert the plug ⑬ into the extension cable ⑪.

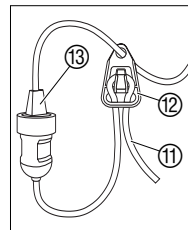

Starting the Hedge Trimmer:

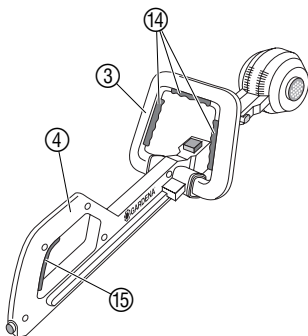

DANGER! Risk of physical injury!

If the Hedge Trimmer does not switch off automatically, there is a risk of lacerations.

→ Never override the safety devices (e.g. by strapping down one of the start buttons).

The hedge trimmer is fitted with a two-handed safety device to prevent the unit from being turned on by accident.

1. Hold the guide handle ③ with one hand and press one of the start buttons ⑭.
2. Hold the main handle ④ with the other hand and press the start button ⑮. *The hedge trimmer will start.*

If either of the start buttons is released, the trimmer blade will come to a halt within one second.

6. Preparation for Storage

Storage:

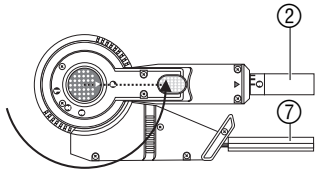

1. Slide the trimmer blade sheath ⑥ over the trimmer blade ⑦.

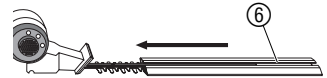

2. Turn the trimmer blade ⑦ to the park position **P**, turn the position of the trimmer blade head to position **3** and fully retract the telescopic handle ② (see 5. Operation).

3. Store the hedge trimmer in a dry, frost free place, out of the reach of children.

Disposal:

(in accordance with
EU-directive 2002/96/EC)



The equipment must not be disposed of as normal household refuse but must be disposed of in the technically correct manner.

7. Maintenance

Cleaning the Hedge Trimmer:



DANGER! Risk of physical injury / electric shock!

→ Always disconnect the hedge trimmer from the power supply and slide the trimmer blade sheath over the trimmer blade before performing any maintenance work.

→ Do not clean the hedge trimmer under running water (especially high pressure).

The safety clutch is a strong spring-loaded device and must not be disassembled.

→ Clean the Hedge Trimmer with a damp cloth and lubricate the trimmer blade with a low viscosity oil (e.g. spray-oil).

8. Troubleshooting



DANGER! Risk of physical injury / electric shock!

→ Always disconnect the hedge trimmer from the power supply and slide the trimmer blade sheath over the trimmer blade before rectifying any faults.

Fault

Possible Cause

Remedy

Hedge trimmer does not start

Extension cable not plugged in or is damaged.

→ Plug in the extension cable or if necessary replace it.

Warning!



Work on the electrical parts must only be carried out by suitably qualified persons.

If any other faults arise, please contact GARDENA Service.

9. Technical Data

THS 400 (Art. 2586)	
Power consumption, motor	350 W
Voltage / Frequency	230 V / 50 Hz
Strokes	2.400/min.
Length of cut	40 cm
Telescopic extension range	0 - 31 cm
Weight	4.3 kg
Workplace related sound pressure level L_{pA} 1)	81 dB (A)
Noise emission value L_{WA} 2)	measured 92 dB (A) / guaranteed 94 dB (A)
Hand / arm vibration a_{vhv} 1)	< 2.5 m/s ²

Measuring process complying with 1) EN 774 2) EU-directive 2000/14/EC

10. Warranty

GARDENA guarantees this product for 3 years (from date of purchase). This guarantee covers all serious defects of the unit that can be proved to be material or manufacturing faults. Under warranty we will either replace the unit or repair it free of charge if the following conditions apply:

- The unit must have been handled properly and in keeping with the requirements of the operating instructions.
- Neither the purchaser nor a non-authorized third party have attempted to repair the unit.

The blade and eccentric drive are wearing parts and are not covered by the guarantee.

This manufacturer's guarantee does not affect the user's existing warranty claims against the dealer/seller.

If a fault occurs with your hedge trimmer, please return the faulty unit together with the receipt and a description of the fault, with postage paid to the address of the Service Centre at the back of these operating instructions.

D <i>Produkthftung</i>	<p>Wir weisen ausdrücklicly darauf hin, dass wir nach dem Produkthftungs-gesetz nicht für durch unsere Geräte hervorgerufene Schäden einzu- stehen haben, sofern diese durch unsachgemäße Reparatur verursacht oder bei einem Teileaustausch nicht unsere Original GARDENA Teile oder von uns freigegebene Teile verwendet werden und die Reparatur nicht vom GARDENA Service oder dem autorisierten Fachmann durchgeführt wird. Entsprechendes gilt für Ergänzungssteile und Zubehör.</p>
GB <i>Product Liability</i>	<p>We expressly point out that, in accordance with the product liability law, we are not liable for any damage caused by our units if it is due to im- proper repair or if parts exchanged are not original GARDENA parts or parts approved by us, and, if the repairs were not carried out by a GARDENA Service Centre or an authorised specialist. The same applies to spare parts and accessories.</p>
F <i>Responsabilité</i>	<p>Nous vous signalons expressément que GARDENA n'est pas respon- sible des dommages causés par ses appareils, dans la mesure où ces dommages seraient causés suite à une réparation non conforme, dans la mesure où, lors d'un échange de pièces, les pièces d'origine GARDENA n'auraient pas été utilisées, ou si la réparation n'a pas été effectuée par le Service Après-Vente GARDENA ou l'un des Centres SAV agréés GARDENA. Ceci est également valable pour tout ajout de pièces et d'ac- cessoires autres que ceux préconisés par GARDENA.</p>
NL <i>Productaansprakelijkheid</i>	<p>Wij wijzen er nadrukkelijk op, dat wij op grond van de wet aansprakelij- heid voor producten niet aansprakelijk zijn voor schade ontstaan door onze apparaten, indien deze door onvakkundige reparatie veroorzaakt zijn, of er bij het uitwisselen van onderdelen geen gebruik gemaakt werd van onze originele GARDENA onderdelen of door ons vrijgegeven onderdelen en de reparatie niet door de GARDENA technische dienst of de bevoegde vak- man uitgevoerd werd. Ditzelfde geldt voor extra-onderdelen en accessoires.</p>
S <i>Produktansvar</i>	<p>Tillverkaren är inte ansvarig för skada som orsakats av produkten om skadan beror på att produkten har reparerats felaktigt eller om, vid repa- ration eller utbyte, andra än Original GARDENA reservdelar har använts. Samma sak gäller för kompletteringsdelar och tillbehör.</p>
I <i>Responsabilità del prodotto</i>	<p>Si rende espressamente noto che, conformemente alla legislazione sulla responsabilità del prodotto, non si risponde di danni causati da nostri arti- coli se originati da riparazioni eseguite non correttamente o da sostituzioni di parti effettuate con materiale non originale GARDENA o comunque da noi non approvato e, in ogni caso, qualora l'intervento non venga eseguito da un centro assistenza GARDENA o da personale specializzato autoriz- zato. Lo stesso vale per le parti complementari e gli accessori.</p>
E <i>Responsabilidad de productos</i>	<p>Advertimos que conforme a la ley de responsabilidad de productos no nos responsabilizamos de daños causados por nuestros aparatos, siempre y cuando dichos daños hayan sido originados por arreglos o reparaciones indebidas, por recambios con piezas que no sean piezas originales GARDENA o bien piezas autorizadas por nosotros, así como en aquellos casos en que la reparación no haya sido efectuada por un Servicio Téc- nico GARDENA o por un técnico autorizado. Lo mismo es aplicable para las piezas complementarias y accesorios.</p>
P <i>Responsabilidade sobre o produto</i>	<p>Queremos salientar que segundo a lei da responsabilidade do fabricante, nós não nos responsabilizaremos por danos causados pelo nosso equipa- mento, quando estes ocorram em decorrência de reparações inadequadas ou da substituição de peças por peças não originais da GARDENA, ou pe- ças não autorizadas. A responsabilidade tornar-se-à nula também depois de reparações realizadas por oficinas não autorizadas pela GARDENA. Esta restrição valerá também para peças adicionais e acessórios.</p>
CZ <i>Ručení za výrobek</i>	<p>Upozorňujeme výslovně na skutečnost, že podle zákona o ručení za výrobky nejsme povinni ručit za škody vyvolané našimi výrobky, pokud tyto škody byly způsobeny neodbornou opravou nebo v případě výměny dílů nebyly použity naše originální díly GARDENA, popř. díly, které jsme schválili, a oprava nebyla provedena v servisu GARDENA nebo autori- zovaným specialistou. Analogické ustanovení platí rovněž pro doplňky a příslušenství.</p>

SK **Zodpovednosť za vady výrobku**

Výslovne zdôrazňujeme, že podľa zákona o ručení za výrobok nie sme zodpovední za škody spôsobené našim zariadením, ak sú spôsobené nesprávnou opravou, alebo ak sa nepoužili originálne diely GARDENA alebo nami schválené diely a ak nebola oprava vykonaná značkovou opravovňou GARDENA alebo autorizovaným odborníkom. To isté platí aj pre doplnkové diely a príslušenstvo.

<p>D EU-Konformitätserklärung MaschinenVerordnung (9. GSGVO) / EMVG / Niedersp. RL</p> <p>Der Unterzeichnete GARDENA Manufacturing GmbH, Hans-Lorenser-Str. 40, D-89079 Ulm, bestätigt, dass das nachfolgend bezeichnete Gerät in der von uns in Verkehr gebrachten Ausführung die Anforderungen der harmonisierten EU-Richtlinien, EU-Sicherheitsstandards und produktspezifischen Standards erfüllt. Bei einer nicht mit uns abgestimmten Änderung des Gerätes verliert diese Erklärung ihre Gültigkeit.</p>	<p>Bezeichnung des Gerätes: Teleskop-Heckenschere Description of the unit: Telescopic Hedge Trimmer Désignation du matériel : Taille-haies télescopique Omschrijving van het apparaat: Telescoop-heggenschaar Produktbeskrivning: Teleskopisk Häcksax Descrizione del prodotto: Tagliasiepi telescopica Descripción de la mercancía: Recortasetos telescópico Descrição do aparelho: Tesoura telescópica de sebes</p>
<p>GB EU Certificate of Conformity</p> <p>The undersigned GARDENA Manufacturing GmbH, Hans-Lorenser-Str. 40, D-89079 Ulm, hereby certifies that, when leaving our factory, the unit indicated below is in accordance with the harmonised EU guidelines, EU standards of safety and product specific standards. This certificate becomes void if the unit is modified without our approval.</p>	<p>Označení přístroje: teleskopické nůžky na živý plot Označenie zariadení: Teleskopické nožnice na živý plot</p>
<p>F Certificat de conformité aux directives européennes</p> <p>Le constructeur, soussigné : GARDENA Manufacturing GmbH, Hans-Lorenser-Str. 40, D-89079 Ulm, déclare qu'à la sortie de ses usines le matériel neuf désigné ci-dessous était conforme aux prescriptions des directives européennes énoncées ci-après et conforme aux règles de sécurité et autres règles qui lui sont applicables dans le cadre de l'Union européenne. Toute modification portée sur ce produit sans l'accord express de GARDENA supprime la validité de ce certificat.</p>	<p>Typ: Art.-Nr.: Type: Art. No.: Type : Référence : Typ: Art. nr.: Type: THS 400 Art.nr.: 2586 Modello: Art.: Tipo: Art. Nº: Tipo: Art. Nº: Typ: Č.výr: Typy: Typové č. :</p>
<p>NL EU-overeenstemmingsverklaring</p> <p>Ondergetekende GARDENA Manufacturing GmbH, Hans-Lorenser-Str. 40, D-89079 Ulm, bevestigt, dat het volgende genoemde apparaat in de door ons in de handel gebrachte uitvoering voldoet aan de eis van, en in overeenstemming is met de EU-richtlijnen, de EU-veiligheidsstandaard en de voor het product specifieke standaard. Bij een niet met ons afgestemde verandering aan het apparaat verliest deze verklaring haar geldigheid.</p>	<p>EU-Richtlijnen: EU directives: Directives européennes : 98/37/EC EU-richtlijnen: EU direktiv : 89/336/EC Directive UE : 2006/95/EC Normativa UE : 93/68/EC Diretrizes da UE : 2000/14/EC Směrnice EU: Smernice EU:</p>
<p>S EU Tillverkarintyg</p> <p>Undertecknad firma GARDENA Manufacturing GmbH, Hans-Lorenser-Str. 40, D-89079 Ulm, intygar härmed att nedan nämnda produkter överensstämmer med EU:s direktiv, EU:s säkerhetsstandard och produktspecifikation. Detta intyg upphör att gälla om produkten ändras utan vårt tillstånd.</p>	<p>Hinterlegte Dokumentation: GARDENA Technische Dokumentation Konformitätsbewertungsverfahren: Nach 2000/14/EG Art. 14 Anhang VI Deposited Documentation: GARDENA Technical Documentation Conformity Assessment Procedure: according to 2000/14/EC Art. 14 Annex VI Documentation déposée : Documentation technique GARDENA Procédure d'évaluation de la conformité : Selon 2000/14/CE art. 14 Annexe VI</p>
<p>I Dichiarazione di conformità alle norme UE</p> <p>La sottoscritta GARDENA Manufacturing GmbH, Hans-Lorenser-Str. 40, D-89079 Ulm, certifica che il prodotto qui di seguito indicato, nei modelli da noi commercializzati, è conforme alle direttive armonizzate UE nonché agli standard di sicurezza e agli standard specifici di prodotto. Qualunque modifica apportata al prodotto senza nostra specifica autorizzazione invalida la presente dichiarazione.</p>	<p>Geräuschemissionswert: gemessen / garantiert Noise level: measured / guaranteed Puissance acoustique : mesurée / garantie Geluidsemisiewaarde: gemeten / gegarandeerd Ljudnivá: uppmätt / garanterad Livello rumorosità: testato / garantito Nível sonoro: medido / garantizado Nível de ruído: medido / garantido Hodnota emise hluku: naměřeno / zaručeno Hodnota hlukových emisí: meraná / garantovaná</p>
<p>E Declaración de conformidad de la UE</p> <p>El que suscribe GARDENA Manufacturing GmbH, Hans-Lorenser-Str. 40, D-89079 Ulm, declara que la presente mercancía, objeto de la presente declaración, cumple con todas las normas de la UE, en lo que a normas técnicas, de homologación y de seguridad se refiere. En caso de realizar cualquier modificación en la presente mercancía sin nuestra previa autorización, esta declaración pierde su validez.</p>	<p>Geräuschemissionswert: gemessen / garantiert Noise level: measured / guaranteed Puissance acoustique : mesurée / garantie Geluidsemisiewaarde: gemeten / gegarandeerd Ljudnivá: uppmätt / garanterad Livello rumorosità: testato / garantito Nível sonoro: medido / garantizado Nível de ruído: medido / garantido Hodnota emise hluku: naměřeno / zaručeno Hodnota hlukových emisí: meraná / garantovaná</p>
<p>P Certificado de conformidade da UE</p> <p>Os abaixo mencionados GARDENA Manufacturing GmbH, Hans-Lorenser-Str. 40, D-89079 Ulm, por este meio certificam que ao sair da fábrica o aparelho abaixo mencionado está de acordo com as diretivas harmonizadas da UE, padrões de segurança e de produtos específicos. Este certificado ficará nulo se a unidade for modificada sem a nossa aprovação.</p>	<p>Geräuschemissionswert: gemessen / garantiert Noise level: measured / guaranteed Puissance acoustique : mesurée / garantie Geluidsemisiewaarde: gemeten / gegarandeerd Ljudnivá: uppmätt / garanterad Livello rumorosità: testato / garantito Nível sonoro: medido / garantizado Nível de ruído: medido / garantido Hodnota emise hluku: naměřeno / zaručeno Hodnota hlukových emisí: meraná / garantovaná</p>

CZ Prohlášení o shodě EU

Niže podepsaná společnost GARDENA Manufacturing GmbH, se sídlem Hans-Lorensen-Str. 40, D-89079 v Ulmu potvrzuje, že níže označený přístroj v provedení, které jsme uvedli na trh, splňuje požadavky uvedené v harmonizovaných směrnicích EU, v bezpečnostních standardech EU a ve standardech pro příslušné produkty. V případě změny přístroje, která námi nebyla odsouhlasena, stává se toto prohlášení neplatným.

SK Vyhlásenie o zho de pre Európsku úniu

Dolu podpísaný, GARDENA Manufacturing GmbH, Hans-Lorensen-Str. 40, D-89079 Ulm, potvrdzuje, že ďalej označené zariadenie vo vyhotovení nami uvedenom do prevádzky spĺňa požiadavky harmonizovaných smerníc Európskej únie, bezpečnostných štandardov Európskej únie a štandardov špecifických pre produkt. Pri vykonaní zmien zariadenia, ktoré nie sú nami odsúhlasené, stráca toto vyhlásenie platnosť.

Anbringningsjaar der CE-Kennzeichnung:

Year of CE marking:

Date d'apposition du marquage CE :

Installatiejaar van de CE-aanduiding:

CE-Märkningsår:

1997

Anno di rilascio della certificazione CE:

Colocación del distintivo CE:

Ano de marcação pela CE:

Rok přidělení značky CE:

Rok inštalácie značky CE:



Thomas Heini

Ulm, den 10.03.1997

Ulm, 10.03.1997

Fait à Ulm, le 10.03.1997

Ulm, 10-03-1997

Ulm, 1997.03.10.

Ulm, 10.03.1997

Ulm, 10.03.1997

Ulm, 10.03.1997

V Ulmu, dne 10.03.1997

Ulm, 10.03.1997

Technische Leitung

Technical Dept. Manager

Direction technique

Hoofd technische dienst

Technical Director

Direzione Tecnica

Dirección Técnica

Director Técnico

Technický ředitel

Vedúci technického

oddelenia

Deutschland / Germany

GARDENA
Manufacturing GmbH
Service Center
Hans-Lorenser-Straße 40
D-89079 Ulm
Produktfragen:
(+49) 731 490-123
Reparaturen:
(+49) 731 490-290
service@gardena.com

Argentina

Argensem® S.A.
Calle Colonia Japonesa s/n
(1625) Loma Verde
Escobar, Buenos Aires
Phone: (+54) 34 88 49 40 40
info@argensem.com.ar

Australia

Nylex Consumer Products
50-70 Stanley Drive
Somerton, Victoria, 3062
Phone: (+61) 1800 658 276
spare.parts@nylex.com.au

Austria / Österreich

GARDENA
Österreich Ges.m.b.H.
Stettnerweg 11-15
2100 Korneuburg
Tel.: (+43) 22 62 7 45 45 36
kundendienst@gardena.at

Belgium

GARDENA Belgium NV/SA
Sterrebeekstraat 163
1930 Zaventem
Phone: (+32) 2 7 20 92 12
Mail: info@gardena.be

Brazil

Palash Comércio e
Importação Ltda.
Rua Américo Brasiliense,
2414 - Chácara Sto Antonio
São Paulo - SP - Brasil -
CEP 04715-005
Phone: (+55) 11 5181-0909
eduardo@palash.com.br

Bulgaria

DENEX LTD.
2 Luis Ahalier Str. - 7th floor
Sofia 1404
Phone: (+359) 2 958 18 21
office@denex-bg.com

Canada

GARDENA Canada Ltd.
100 Summerlea Road
Brampton, Ontario L6T 4X3
Phone: (+1) 905 792 93 30
info@gardenacanada.com

Chile

Antonio Martinic y Cia Ltda.
Cassillas 272
Centro de Cassillas
Santiago de Chile
Phone: (+56) 2 20 10 708
garfar_cl@yahoo.com

Costa Rica

Compania Exim
Euroberoamericana S.A.
Los Colegios, Moravia,
200 metros al Sur del Colegio
Saint Francis - San José
Phone: (+506) 297 68 83
exim_euro@racsa.co.cr

Croatia

KLIS d.o.o.
Stanciceva 79
10419 Vukovina
Phone: (+385) 1 622 777 0
gardena@klis-trgovina.hr

Cyprus

FARMOKIPIKI LTD
P.O. Box 7098
74, Digeni Akritra Ave.
1641 Nicosia
Phone: (+357) 22 75 47 62
condam@spidernet.com.cy

Czech Republic

GARDENA spol. s r.o.
Řípská 20a, č.p. 1153
627 00 Brno
Phone: (+420) 800 100 425
gardena@gardenabrnmo.cz

Denmark

GARDENA Norden AB
Salgsafdeling Danmark
Box 9003
S-200 39 Malmö
info@gardena.dk

Finland

Habitec Oy
Martinkyläntie 52
01720 Vantaa

France

GARDENA
PARIS NORD 2
69, rue de la Belle Etoile
BP 57080
ROISSY EN FRANCE
95948 ROISSY CDG CEDEX
Tél. (+33) 0826 101 455
service.consommateurs@
gardena.fr

Great Britain

GARDENA UK Ltd.
27-28 Brenkley Way
Bleazard Business Park
Seaton Burn
Newcastle upon Tyne
NE13 6DS
info@gardena.co.uk

Greece

Agrokrip
Psomadopoulos S.A.
Ifaistou 33A
Industrial Area Koropi
194 00 Athens Greece
V.A.T. EL093474846
Phone: (+30) 210 66 20 225
service@agrokrip.gr

Hungary

GARDENA
Magyarország Kft.
Késmárk utca 22
1158 Budapest
Phone: (+36) 80 20 40 33
gardena@gardena.hu

Iceland

Ó. Johnson & Kaaber
Tunguhalsi 1
110 Reykjavik
oaj@ojk.is

Ireland

Michael McLoughlin & Sons
Hardware Limited
Long Mile Road
Dublin 12

Italy

GARDENA Italia S.p.A.
Via Donizetti 22
20020 Lainate (Mi)
Phone: (+39) 02.93.94.79.1
info@gardenaitalia.it

Japan

KAKUICHI Co. Ltd.
Sumitomo Realty &
Development Kojimachi
BLDG., 8F
5-1 Nibanncyo, Chiyoda-ku
Tokyo 102-0084
Phone: (+81) 33 264 4721
m_ishihara@kaku-ichi.co.jp

Luxembourg

Magasins Jules Neuberg
Grand Rue 30
Boîte postale 12
L-2010 Luxembourg
Phone: (+352) 40 14 01
info@neuberg.lu

Netherlands

GARDENA Nederland B.V.
Postbus 50176
1305 AD ALMERE
Phone: (+31) 36 521 00 00
info@gardena.nl

Neth. Antilles

Jonka Enterprises N.V.
Sta. Rosa Weg 196
P.O. Box 8200
Curaçao
Phone: (+599) 9 767 66 55
pgm@jonka.com

New Zealand

NYLEX New Zealand Limited
Building 2, 118 Savill Drive
Mangere, Auckland
Phone: (+64) 9 270 1806
lena.chapman@nylex.com.au

Norway

GARDENA Norden AB
Salgskontor Norge
Karihaugveien 89
1086 Oslo
info@gardena.no

Poland

GARDENA Polska Sp. z o.o.
Szymanów 9 d
05-532 Baniocza
Phone: (+48) 22 727 56 90
gardena@gardena.pl

Portugal

GARDENA Portugal Lda.
Recta da Granja do Marquês
Edif. GARDENA Algueirão
2725-596 Mem Martins
Phone: (+351) 21 922 85 30
info@gardena.pt

Romania

MADEX INTERNATIONAL SRL
Soseaua Odaii 117-123,
Sector 1,
București, RO 013603
Phone: (+40) 21 352 76 03
madex@ines.ro

Russia / Россия

ООО ГАРДЕНА РУС
123007, г. Москва
Хорошевское шоссе, д. 32А
Тел.: (+7) 495 247 25 10
info@gardena-rus.ru

Singapore

Hy - Ray PRIVATE LIMITED
40 Jalan Pemimpin
#02-08 Tat Ann Building
Singapore 577185
Phone: (+65) 6253 2277
hyray@singnet.com.sg

Slovak Republic

GARDENA Slovensko, s.r.o.
Panónska cesta 17
851 04 Bratislava
Phone: (+421) 263 453 722
info@gardena.sk

Slovenia

GARDENA d.o.o.
Brodišče 15
1236 Trzin
Phone: (+386) 1 580 93 32
servis@gardena.si

South Africa

GARDENA
South Africa (Pty.) Ltd.
P.O. Box 11534
Vorna Valley 1686
Phone: (+27) 11 315 02 23
sales@gardena.co.za

Spain

GARDENA IBÉRICA S.L.U.
C/ Basauri, nº 6
La Florida
28023 Madrid
Phone: (+34) 91 708 05 00
atencioncliente@gardena.es

Sweden

GARDENA Norden AB
Försäljningskontor Sverige
Box 9003
200 39 Malmö
info@gardena.se

Switzerland / Schweiz

GARDENA (Schweiz) AG
Bitzberg 1
1814 Bachenbülach
Phone: (+41) 848 800 464
info@gardena.ch

Turkey

GARDENA / Dost Diş Ticaret
Mümesillik A.Ş. Sanayi
Çad. Adil Sokak No. 1
Kartal - İstanbul
Phone: (+90) 216 38 93 939
info@gardena-dost.com.tr

Ukraine / Украина

ALTEST JSC
4 Petropavlivska Street
Petropavlivska
Borschahivka Town
Kyivo Svyatoshyn Region
08130, Ukraine
Phone: (+380) 44 459 57 03
upyr@altsest.kiev.ua

USA

Melnor Inc.
3085 Shawnee Drive
Winchester, VA 22604
Phone: (+1) 540 722-9080
service_us@melnor.com

2586-20.960.10/0207

© GARDENA

Manufacturing GmbH
D-89070 Ulm

http://www.gardena.com